



Designed to get the job done

BMP51 Label printer

Designed to get the job done

The Brady Advantage

When it comes to identification, safety and compliance, there's a clear advantage to working with Brady. We put our customers first in everything we do.

Our goal is to give you an unrivalled customer experience. We are relentlessly committed to performance and excellence - in our products, services and people.

Our products and solutions perform in ways that others simply can't match. Our people perform in ways that regularly exceed your expectations, and our focus and discipline work toward solid, long-term performance for our customers.

In short, Brady is the company you trust when performance matters most.

Learn more about the Brady Advantage at: www.bradyeurope.com

Table of contents

3	BMP51 Label Printer
6	Applications
10	BMP51 Media offering
12	Electrical, voice/datacom identification
18	General & industrial identification
20	Laboratory identification
29	Master material index
31	Software
32	Printer specifications
33	BMP51 Printer, kits and accessories
34	Brady technical service
35	Brady support



BMP51
LABEL PRINTER



Brady products are sold on the condition that the purchaser will test them in actual use and determine for himself/herself their suitability to his/her intended purpose. Brady warrants to the purchaser that Brady products are free from defects in material and workmanship but limits its obligation under this warranty to the replacement of the product which has been shown to Brady's satisfaction to have been defective at the time of its purchase.

The warranty does not extend to any persons who have acquired the product from the purchaser. It is in lieu of any other warranty, including every warranty of sale-ability, marketability or suitability for the intended purpose, and is also in lieu of any other obligation or liability on the part of Brady.

Under no circumstances will Brady be liable for losses, damage, costs or subsequent damage of whatever nature which may arise in connection with the use of, or inability to use, Brady's products.

Designed to get the job done

When you need clear, durable labels on the spot, you need the BMP51 Label Printer from Brady. It offers crisp printing, easy formatting, convenient label sizes, and portability required for electrical and datacom installations, laboratory identification, facility and safety labelling.

Get the job done FASTER.

Change supplies in seconds. Hassle free drop-in cartridges have both the label material & ribbon inside!

Automatic label formatting. Cartridges feature smart cell technology that tells the printer how to correctly format your label. You just drop in a cartridge and the printer calibrates the rest.

Quick to print. Prints 25.40 mm per second – which means no more waiting around for labels to print.

Durable built-in cutter. There's a self-cleaning cutter that can cut through any material with ease, and it even grips the label until you need it.

Get the job done EASIER.

Battery options for portability. Use with the AC power supply, AA-batteries or simply with the rechargeable Li-Ion battery which allows you to print over 3,000 labels on a single charge.

Wireless capabilities. Built-in Bluetooth® technology and the optional Wi-Fi card provide wireless printing options.

Robust software. Labelling Software enables the printer to print: bar code symbologies, time/date stamps, imported graphics, automatic data serialisation, and more.

Continuous & die-cut label materials. Whether you need to label wires, cables, panels or equipment, you can do it all with this one printer. There are 20 material types and more than 200 label parts to choose from.

Labels up to 38.10 mm wide. Make large labels that can easily be identified from a distance (or make continuous labels up to 1m long!).

Magnet. Keep your printer handy, use the magnet to hold your printer on panel doors, metal ladders or any metal surface.

Get the job done WITH CONFIDENCE.

Label for the long haul. Our labels won't fade, smear or fall off – so you only need to label something once.

A rugged printer you can rely on. This printer can survive in all kinds of harsh environments, temperatures and has a rugged, drop tested construction.



BMP51 at a glance

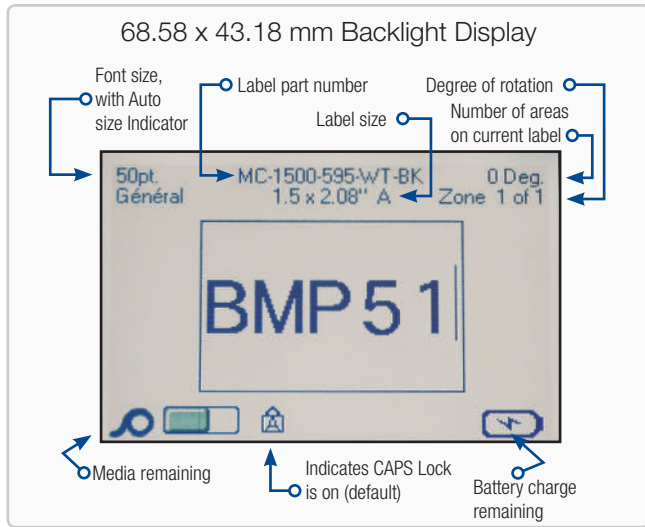

2 YEAR WARRANTY

Connectivity

Built-in Bluetooth card, optional wifi card for wireless printing via a network: making it quick & easy to print without being physically connected to multiple PCs.



Battery options

3 power options: AA batteries, AC adaptor or rechargeable Li-Ion battery

The printer can be powered through a designated AC power adapter. When the adapter is plugging in, it will also charge the BMP Lithium Ion Battery Pack if one is inserted in the battery compartment (it will not charge AA rechargeable batteries).



Hassle-free drop-in cartridges

Ribbon and label materials in ONE cartridge!

- Install or remove ribbon and material in one easy step
- No need to worry about having the right ribbon for your materials
- Ribbon and material runs out at the same time (less waste!)

Easy-to-load cartridges with “No Jam” technology.

- Top-loading cartridge that snaps into place (you can't load it wrong!)
- Easy access to cartridge for quick changes
- Locking mechanism prevents labels from retracting into cartridge



Electrical, voice/datacom identification

Wire & cable marking for twisted pair data cables (UTP, FTP...), fibre optic cables, conductors, computer wires, electrical installation wires & cables, power & ground cables, energy cables...



Flags



Tags

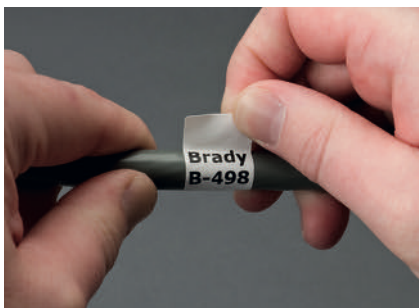

Wrap-around labels



Self-lams



Sleeves

Component marking for patch panels, control panels, punch blocks, terminal blocks, breaker boxes, face-plates...



Punch block & patch panel labels

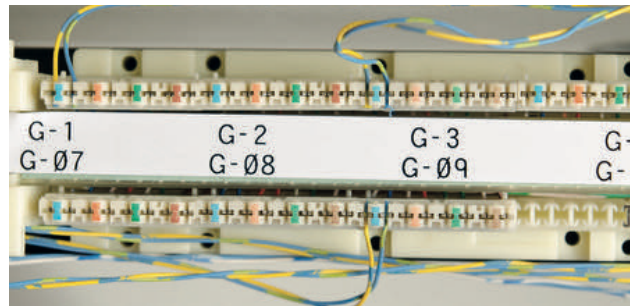

Terminal block labels

General & industrial identification

Asset & component marking to be used on all kind of surfaces (smooth, rough, textured, low energy...).



Rating & name plate labels

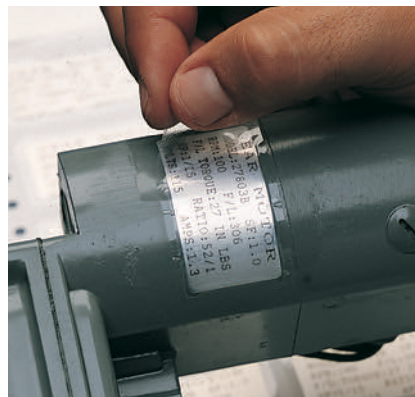

Overlaminated labels



Pre-printed labels

Facility & safety identification

Lean warehouse identification



Laboratory identification

Specimen tracking identification for sample tracking within histology labs: utilize barcode technology to prevent misdiagnosis.



Straws & rods



Conical & large tube labels

Specimen process marking supporting microscopic analysis of cells and tissues within pathology and clinical labs.



Centrifuge, eppendorf & PCR labels



Slide labels



Tissue cassettes

Specimen storage identification supporting specimen collection and handling such as blood samples, cryo-samples etc.

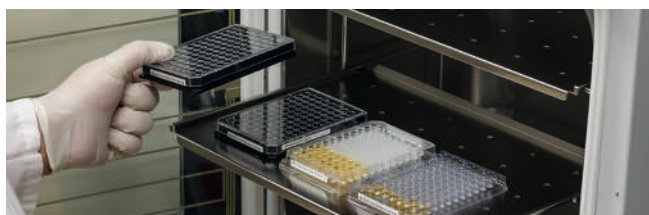

Well plate labels



Cryo labels

Lean lab identification for general supplies marking.



General lab equipment labels



Removable labels for glassware



Bottle tamper seal labels

Ever lost time figuring out where each wire goes?

Durable professional labels that remain legible and stay attached in harsh conditions are extremely important to keep power, network, voice and data cables and components organised and running effectively.

Professional identification on wires, cables and components enables you to:

- immediately recognise what needs checking during troubleshooting
- clearly mark parts for upcoming maintenance upgrades
- trace history, lifespan and supplier
- add safety warnings or precautions

Ask yourself how much time or money you lose while trying to trace an unidentified faulty cable, wire or component.

Ask yourself how fast pressure builds when machinery, production lines, servers and services are impacted.

This is when professional labelling pays off big time.



The combination of label liner, adhesive, substrate and topcoat provide a professional label's features, resistances, capabilities and durability.

- 1 The topcoat gives the label its colour and finish, receives the print, and increases resistance against weathering, flames, chemicals or heat.
- 2 The substrate gives the label its form and provides tensile properties such as strength and flexibility and physical properties such as chemical and temperature resistance.
- 3 The adhesive attaches the label to a chosen surface type and ensures resistance against a set of environmental contexts.
- 4 The label liner is a very thin carrier that releases the self-adhesive label.

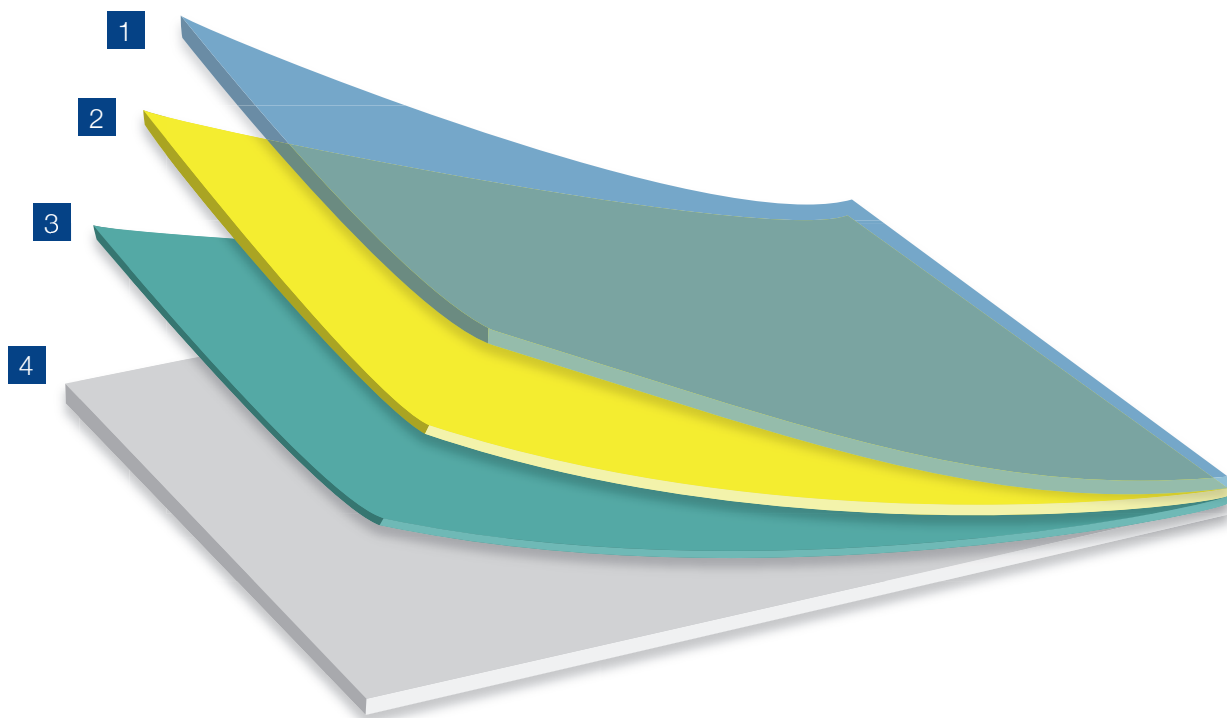

Which label suits your needs best?

Request your Electrical, Tele- & Datacom Identification guide book to help you choose the optimal Brady label material for your application at www.bradyeurope.com/cableID.

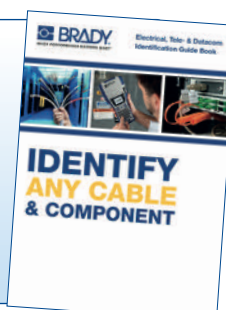

BMP51 media offering

We continuously try to improve & extend our label material offering, therefore make sure to check for firmware upgrades regularly, in order to make sure you always have access to the newest materials.

Material	
B-109	Polyethylene Tag
B-145	Polyethylene Tag
B-342	Heat-shrink Polyolefin Sleeve
B-351	Tamper-resistant Vinyl
B-403	Paper
B-412	Polypropylene Tag
B-422	Polyester
B-425A	Polypropylene
B-427	Self-laminating Vinyl
B-428	Metallised Polyester
B-432	Polyester
B-461	Self-laminating Polyester

Material	
B-481	StainerBondz™ Polyester
B-482	Polyester
B-483	Polyester
B-488	Polyester
B-490	Freezerbondz™ Polyester
B-492	Freezerbondz™ Polyester
B-498	Vinyl Cloth
B-499	Nylon Cloth
B-584	Reflective Tape
B-595	Vinyl
B-7425	Polypropylene
B-7641	Heat-shrink Polyolefin Sleeve

Compatible Media:

M-, MC-, MC1- Series Cartridges (All sizes)



38.1 mm height



25.4 mm height



19.05 mm height

Smart-Cell Technology

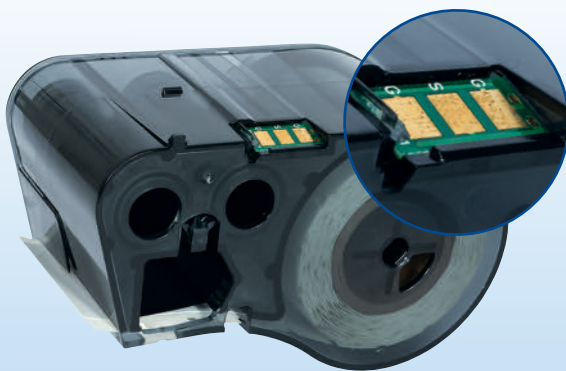

With smart-cell technology built into label rolls and ribbons, the printers are able to automatically format the label and place objects so that there is no guess work on your part. If the label material & ribbon are not compatible, the screen will show an error message.

Variable Font Sizes

Font sizes range from 4 to 103 point.
 The maximum font size available depends on factors such as label size, number of characters, number of lines, as well as font sizes in other lines.

Point Size	Print Sample
4	ABC 12345
6	ABC 12345
7	ABC 12345
9	ABC 12345
10	ABC 12345
14	ABC 12345
16	ABC 12345
20	ABC 12345
26	ABC 12345
32	ABC 12345
40	ABC 12345
45	ABC 1234
51	ABC 123
55	ABC 123
60	ABC 123
65	ABC 12
70	ABC 12
76	AB 12
102	AB 12

Barcode Types



- Code 39 and Code 128
- Other barcodes supported in combination with LabelMark or Brady Workstation

Symbol Library

- Standard electrical and datacom symbols
- Over 450 built in graphics
- Built in time/date stamp

 Arrows	 Datacom	 Electrical
 Exit	 Fire	 First aid
 CLP/GHS	 Home electrical	 International
 Mandatory	 Packaging	 Prohibition
 Public info	 Warning	 WHMIS

...and many more

Wire & cable marking



Cable flags

Pre-formatted with two printable areas, allowing label to be easily folded around wires to create a two-sided, printed flag. Information is still legible on smaller diameter wires and the flag permits you to handle and view labels without touching the wires.

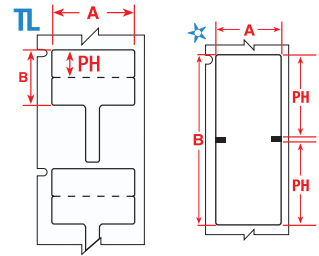

Diagram	Order Reference	Colour	Label Width A (mm)	Label Height B (mm)	Printable Area Height PH (mm)	Labels per Roll	Additional Features	Printer Compatibility
B-425: Polypropylene								
TL	MFT-01-425	Black on White	30.00	20.00	10.00	200	Ideal for Fibre Optic Labelling	BMP51; BMP53
B-499: Nylon Cloth								
☆	M-141-499	Black on White	25.40	57.15	25.40	90		BMP41; BMP51; BMP53
☆	M-152-499	Black on White	38.10	31.75		160	Low profile; High adhesion	BMP51; BMP53



Tags for communications cables

Multi-purpose tag that can be used for a variety of applications including identification of multiconductor cables, inventory, equipment, lockout, safety warning repair and work-in-progress. Extremely tear resistant.

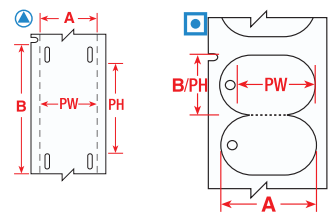

Diagram	Order Reference	Colour	Label Width A (mm)	Label Height B (mm)	Printable Area Width PW (mm)	Printable Area Height PH (mm)	Labels per Roll	Additional Features	Printer Compatibility
B-109: Polyethylene Tag									
⊙	M-12-109	Black on White	19.05	76.20	19.05	56.00	80	Good cold-weather tag	BMP51; BMP53
B-145: Polyethylene Tag									
⊙	M-111-145FR-GY	Black on Grey	30.63	19.25	20.62	19.25	65	Flame Retardant	BMP51; BMP53



Wrap around wire & cable markers

Durable vinyl cloth wrap around wire and cable markers made with an adhesive that allows the markers to be removed cleanly and reapplied if necessary.

Diagram	Order Reference	Colour	Label Width A (mm)	Label Height B (mm)	Label Length B (m)	Max. Wire Diameter (mm)	Labels per Roll	Printer Compatibility
B-498: Vinyl Cloth								
▲	M-7-498	Black on White	12.70	12.70	-	2.80	240	BMP41; BMP51; BMP53
▲	M-11-498	Black on White	19.05	12.70	-	4.00	220	BMP41; BMP51; BMP53
▲	M-48-498	Black on White	25.40	19.05	-	5.10	180	BMP41; BMP51; BMP53
▲	M-49-498	Black on White	25.40	25.40	-	5.10	160	BMP41; BMP51; BMP53
▲	M-91-498	Black on White	25.40	38.10	-	7.10	120	BMP41; BMP51; BMP53
▲	M-131-498	Black on White	12.70	25.40	-	5.10	180	BMP41; BMP51; BMP53
B-499: Nylon Cloth								
⊙	MC-375-499	Black on White	9.53	-	4.88	-	1	BMP41; BMP51; BMP53
⊙	MC-500-499	Black on White	12.70	-	4.88	-	1	BMP41; BMP51; BMP53
⊙	MC-1000-499	Black on White	25.40	-	4.88	-	1	BMP51; BMP53
⊙	MC-750-499	Black on White	19.05	-	4.88	-	1	BMP41; BMP51; BMP53

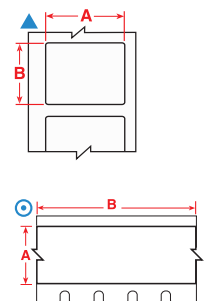

Wire & cable marking



PermaSleeve PS wire marking sleeves

These heat-shrink sleeves are the ultimate in marker durability, permanence and aesthetic appearance. Fast shrink rate saves time and costs during installation. Available as individual die-cut markers or continuous cut-to-length tubing.

Diagram	Order Reference	Colour	Label Width A (mm)	Label Height B (mm)	Label Length B (m)	Min. Wire Diameter (mm)	Max. Wire Diameter (mm)	Labels per Roll	Printer Compatibility
B-342: Heat-shrink Polyolefin Sleeve									
V	M-187-075-342	Black on White	19.05	8.50	–	1.57 mm	3.81 mm	80	BMP41; BMP51; BMP53
V	M-250-075-342	Black on White	19.05	11.15	–	2.39 mm	5.46 mm	80	BMP41; BMP51; BMP53
V	M-125-075-342	Black on White	19.05	6.00	–	1.17 mm	2.79 mm	80	BMP41; BMP51; BMP53
V	M-375-075-342	Black on White	19.05	16.40	–	3.18 mm	8.13 mm	80	BMP41; BMP51; BMP53
V	M-125-1-342	Black on White	25.78	6.00	–	1.17 mm	2.79 mm	80	BMP51; BMP53
V	M-187-1-342	Black on White	25.78	8.50	–	1.57 mm	3.81 mm	80	BMP51; BMP53
V	M-250-1-342	Black on White	25.78	11.15	–	2.39 mm	5.46 mm	80	BMP51; BMP53
V	M-375-1-342	Black on White	25.78	16.40	–	3.18 mm	8.13 mm	80	BMP51; BMP53
⊙	MC-187-342	Black on White		8.50	2.13	1.57 mm	3.81 mm	1	BMP41; BMP51; BMP53
⊙	MC-125-342	Black on White		6.00	2.13	1.17 mm	2.79 mm	1	BMP41; BMP51; BMP53
⊙	MC-250-342	Black on White		11.15	2.13	2.39 mm	5.46 mm	1	BMP41; BMP51; BMP53
⊙	MC1-375-342	Black on White		16.40	2.13	3.18 mm	8.13 mm	1	BMP41; BMP51; BMP53
⊙	MC-187-342-YL	Black on Yellow		8.50	2.13	1.57 mm	3.81 mm	1	BMP41; BMP51; BMP53
⊙	MC-125-342-YL	Black on Yellow		6.00	2.13	1.17 mm	2.79 mm	1	BMP41; BMP51; BMP53
⊙	MC-250-342-YL	Black on Yellow		11.15	2.13	2.39 mm	5.46 mm	1	BMP41; BMP51; BMP53

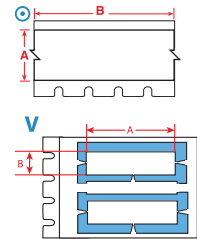

PermaSleeve heat-shrink sleeve markers

These heat-shrink sleeves are the ultimate in marker identification, protection, durability and aesthetic appearance. Fast shrink rate saves time and costs during installation. Low smoke zero halogen wire marking sleeves (B-7641) offer outstanding fire safety properties and minimal smoke emission.

Diagram	Order Reference	Colour	Label Width A (mm)	Label Length B (m)	Min. Wire Diameter (mm)	Max. Wire Diameter (mm)	Labels per Roll	Printer Compatibility
B-7641: Heat-shrink Polyolefin Sleeve								
♥	MC1-125-7641	Black on White	6.00	2.13	1.17 mm	2.79 mm	1	BMP51; BMP53
♥	MC1-125-7641-YL	Black on Yellow	6.00	2.13	1.17 mm	2.79 mm	1	BMP51; BMP53
♥	MC1-187-7641	Black on White	8.50	2.13	1.57 mm	3.81 mm	1	BMP51; BMP53
♥	MC1-187-7641-YL	Black on Yellow	8.50	2.13	1.57 mm	3.81 mm	1	BMP51; BMP53
♥	MC1-250-7641	Black on White	11.15	2.13	2.39 mm	5.46 mm	1	BMP51; BMP53
♥	MC1-250-7641-YL	Black on Yellow	11.15	2.13	2.39 mm	5.46 mm	1	BMP51; BMP53
♥	MC1-375-7641	Black on White	16.40	2.13	3.18 mm	8.13 mm	1	BMP51; BMP53
♥	MC1-375-7641-YL	Black on Yellow	16.40	2.13	3.18 mm	8.13 mm	1	BMP51; BMP53

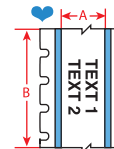

Did you know?

The BMP51 Label Maker has a built-in label retention feature, that grips the label until you need it. Paired with the magnet accessory, this is the ultimate answer to your “on the job” labelling requirements.

Component marking

Punch block & patch panel labels

Make fully-formatted punch block strips or labels in one easy process. Labelling software allows you to easily create serialised punch block labels with or without grid lines to fit your equipment.

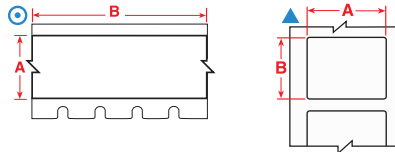

Diagram	Order Reference	Colour	Label Width A (mm)	Label Height B (mm)	Label Length B (m)	Labels per Roll	Additional Features	Printer Compatibility
B-412: Polypropylene Tag								
⊙	MC-375-412	Black on White	9.53		6.10	1	Non-Adhesive Slide-in Strips	BMP41; BMP51; BMP53
⊙	MC-475-412	Black on White	12.07		6.10	1	Non-Adhesive Slide-in Strips	BMP41; BMP51; BMP53
⊙	MC-625-412	Black on White	15.88		6.10	1	Non-Adhesive Slide-in Strips	BMP41; BMP51; BMP53
B-422: Polyester								
▲	M-7-422	Black on White	12.70	12.70		280	Port Labels	BMP41; BMP51; BMP53
⊙	MC-375-422	Black on White	9.53		7.62	1	Adhesive Stick-on Strips: Outlet, Patch Panel, Cont. Tape, Cut to Size	BMP41; BMP51; BMP53
⊙	MC-475-422	Black on White	12.07		7.62	1	Adhesive Stick-on Strips: Outlet, Patch Panel, Cont. Tape, Cut to Size	BMP41; BMP51; BMP53
⊙	MC-625-422	Black on White	15.88		7.62	1	Adhesive Stick-on Strips: Outlet, Patch Panel, Cont. Tape, Cut to Size	BMP41; BMP51; BMP53

Terminal block markers

Specially-designed narrow-width markers. Labelling Software can auto-serialise these labels to save you time.

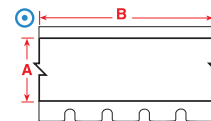

Diagram	Order Reference	Colour	Label Width A (mm)	Label Length B (m)	Labels per Roll	Printer Compatibility
B-498: Vinyl Cloth						
⊙	MC-240-498	Black on White	6.10	4.88	1	BMP41; BMP51; BMP53
⊙	MC-318-498	Black on White	8.08	4.88	1	BMP41; BMP51; BMP53
⊙	MC-375-498	Black on White	9.53	6.10	1	BMP41; BMP51; BMP53

Component Marking



General datacom identification

Durable materials with permanent adhesive. Available in a variety of sizes and colours for marking racks, bays, frames, slots, and other voice/data hardware.

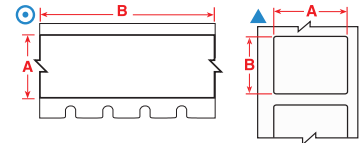

Diagram	Order Reference	Colour	Label Width A (mm)	Label Height B (mm)	Label Length B (m)	Labels per Roll	Additional Features	Printer Compatibility
B-422: Polyester								
▲	M-89-422	Black on White	12.70	38.10		180	Stick-on Individual Labels	BMP41; BMP51; BMP53
▲	M-7-422	Black on White	12.70	12.70		280	Port Labels	BMP41; BMP51; BMP53
◎	MC1-1000-422	Black on White	25.40		7.62	1	Adhesive Stick-on Strips: Outlet, Patch Panel, Cont. Tape, Cut to Size	BMP41; BMP51; BMP53
▲	M-49-422	Black on White	25.40	25.40		260	Adhesive Stick-on individual labels	BMP41; BMP51; BMP53
B-483: Polyester								
▲	M-61-483	Black on White	12.70	50.80		80	Ultra-aggressive adhesive; Designed for powder coated surfaces	BMP41; BMP51; BMP53
▲	M-60-483	Black on White	25.40	50.80		140	Ultra-aggressive adhesive; Designed for powder coated surfaces	BMP41; BMP51; BMP53
▲	M-47-483	Black on White	25.40	12.70		480	Ultra-aggressive adhesive; Designed for powder coated surfaces	BMP41; BMP51; BMP53
B-595: Vinyl								
◎	MC-375-595-WT-BK	Black on White	9.53		7.62	1	Adhesive Stick on Strips, Cut to Size	BMP41; BMP51; BMP53
◎	MC-375-595-YL-BK	Black on Yellow	9.53		7.62	1	Adhesive Stick on Strips, Cut to Size	BMP41; BMP51; BMP53
◎	MC-500-595-YL-BK	Black on Yellow	12.70		7.62	1	Adhesive Stick on Strips, Cut to Size	BMP41; BMP51; BMP53
◎	MC-750-595-YL-BK	Black on Yellow	19.05		7.62	1	Adhesive Stick on Strips, Cut to Size	BMP41; BMP51; BMP53
◎	MC1-1000-595-YL-BK	Black on Yellow	25.40		7.62	1	Adhesive Stick on Strips, Cut to Size	BMP41; BMP51; BMP53
◎	MC-1500-595-YL-BK	Black on Yellow	38.10		7.62	1	Adhesive Stick on Strips, Cut to Size	BMP51; BMP53
◎	MC-500-595-CL-WT	White on Clear	12.70		6.10	1	Adhesive Stick on Strips, Cut to Size	BMP41; BMP51; BMP53
◎	MC-750-595-CL-WT	White on Clear	19.05		6.10	1	Adhesive Stick on Strips, Cut to Size	BMP41; BMP51; BMP53
◎	MC1-1000-595-CL-WT	White on Clear	25.40		6.10	1	Adhesive Stick on Strips, Cut to Size	BMP41; BMP51; BMP53
◎	MC-1500-595-CL-WT	White on Clear	38.10		6.10	1	Adhesive Stick on Strips, Cut to Size	BMP51; BMP53
◎	MC-375-595-RD-WT	White on Red	9.53		7.62	1	Adhesive Stick on Strips, Cut to Size	BMP41; BMP51; BMP53



General electrical component marking

Various sizes, colours and label types for marking relays, solenoids, switches, drive motors, and other components.

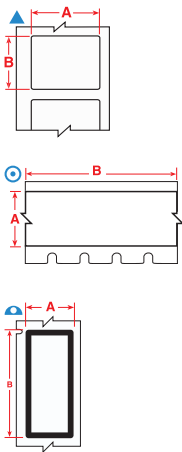

Diagram	Order Reference	Colour	Label Width A (mm)	Label Height B (mm)	Label Length B (m)	Labels per Roll	Printer Compatibility
B-422: Polyester							
▲	M-89-422	Black on White	12.70	38.10		180	BMP41; BMP51; BMP53
▲	M-7-422	Black on White	12.70	12.70		280	BMP41; BMP51; BMP53
▲	M-49-422	Black on White	25.40	25.40		260	BMP41; BMP51; BMP53
◎	MC1-1000-422	Black on White	25.40		7.62	1	BMP41; BMP51; BMP53
B-428: Metallised Polyester							
▲	M-92-428-BB	Black on Silver	12.70	33.02		239	BMP41; BMP51; BMP53
▲	M-47-428	Black on Silver	25.40	12.70		480	BMP41; BMP51; BMP53
▲	M-60-428	Black on Silver	25.40	50.80		140	BMP41; BMP51; BMP53
▲	M-30-428	Black on Silver	38.1	19.05		260	BMP51; BMP53
▲	M-29-428	Black on Silver	38.10	12.70		360	BMP51; BMP53
B-483: Polyester							
▲	M-61-483	Black on White	12.70	50.80		80	BMP41; BMP51; BMP53
▲	M-60-483	Black on White	25.40	50.80		140	BMP41; BMP51; BMP53
B-499: Nylon Cloth							
▲	M-11-499	Black on White	19.05	12.70		220	BMP41; BMP51; BMP53
▲	M-84-499	Black on White	22.86	12.70		200	BMP51; BMP53
▲	M-128-499	Black on White	25.40	48.26		100	BMP41; BMP51; BMP53
▲	M-132-499	Black on White	38.10	31.75		160	BMP51; BMP53
B-595: Vinyl							
◎	MC-375-595-RD-WT	White on Red	9.53		7.62	1	BMP41; BMP51; BMP53
◎	MC-500-595-OR-BK	Black on Orange	12.70		7.62	1	BMP41; BMP51; BMP53
◎	MC-750-595-OR-BK	Black on Orange	19.05		7.62	1	BMP41; BMP51; BMP53
◎	MC1-1000-595-OR-BK	Black on Orange	25.40		7.62	1	BMP41; BMP51; BMP53
◎	MC-1500-595-OR-BK	Black on Orange	38.10		7.62	1	BMP51; BMP53

Component marking

Faceplate & outlet labels

Label your ports, jacks, and outlets with a variety of adhesive labels or slide-in strips.

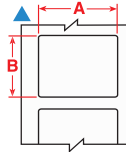
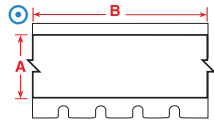

Diagram	Order Reference	Colour	Label Width A (mm)	Label Height B (mm)	Label Length B (m)	Labels per Roll	Additional Features	Printer Compatibility
B-412: Polypropylene Tag								
⊙	MC-475-412	Black on White	12.07		6.10	1	Non-Adhesive Slide-in Strips	BMP41; BMP51; BMP53
B-422: Polyester								
▲	M-89-422	Black on White	12.70	38.10		180	Stick-on Individual Labels	BMP41; BMP51; BMP53
▲	M-7-422	Black on White	12.70	12.70		280	Port Labels	BMP41; BMP51; BMP53
⊙	MC-375-422	Black on White	9.53		7.62	1	Adhesive Stick-on Strips: Outlet, Patch Panel, Cont. Tape, Cut to Size	BMP41; BMP51; BMP53
⊙	MC-475-422	Black on White	12.07		7.62	1	Adhesive Stick-on Strips: Outlet, Patch Panel, Cont. Tape, Cut to Size	BMP41; BMP51; BMP53
B-483: Polyester								
▲	M-61-483	Black on White	12.70	50.80		80	Ultra-aggressive adhesive; Designed for powder coated surfaces	BMP41; BMP51; BMP53

Control panel and electrical panel labels

Long-lasting, durable materials to quickly identify control and electrical panels.

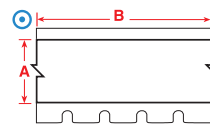
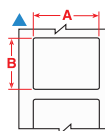

Diagram	Order Reference	Colour	Label Width A (mm)	Label Height B (mm)	Label Length B (m)	Labels per Roll	Printer Compatibility
B-428: Metallised Polyester							
▲	M-47-428	Black on Silver	25.40	12.70		480	BMP41; BMP51; BMP53
▲	M-60-428	Black on Silver	25.40	50.80		140	BMP41; BMP51; BMP53
▲	M-30-428	Black on Silver	38.1	19.05		260	BMP51; BMP53
▲	M-29-428	Black on Silver	38.10	12.70		360	BMP51; BMP53
B-595: Vinyl							
⊙	MC-1500-595-CL-BK	Black on Clear	38.10		6.10	1	BMP51; BMP53
⊙	MC-1500-595-CL-WT	White on Clear	38.10		6.10	1	BMP51; BMP53
⊙	MC-375-595-RD-WT	White on Red	9.53		7.62	1	BMP41; BMP51; BMP53
⊙	MC-1500-595-OR-BK	Black on Orange	38.10		7.62	1	BMP51; BMP53
⊙	MC-1500-595-WT-BK	Black on White	38.10		7.62	1	BMP51; BMP53
⊙	MC-1500-595-YL-BK	Black on Yellow	38.10		7.62	1	BMP51; BMP53
⊙	MC-1500-595-WT-RD	Red on White	38.10		7.62	1	BMP51; BMP53
⊙	MC-1500-595-BK-WT	White on Black	38.10		7.62	1	BMP51; BMP53
⊙	MC-1500-595-BL-WT	White on Blue	38.10		7.62	1	BMP51; BMP53
⊙	MC-1500-595-GN-WT	White on Green	38.10		7.62	1	BMP51; BMP53
⊙	MC-1500-595-RD-WT	White on Red	38.10		7.62	1	BMP51; BMP53

General & industrial identification

Asset & component marking



Tamper-resistant labels

Destructible vinyl material prohibits one piece removal of label to indicate if the label has been tampered with.

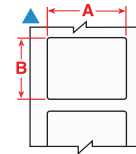

Diagram	Order Reference	Colour	Label Width A (mm)	Label Height B (mm)	Labels per Roll	Printer Compatibility
B-351: Tamper-resistant Vinyl						
▲	M-17-351	Black on White	25.40	12.70	360	BMP51; BMP53
▲	M-20-351	Black on White	25.40	50.80	160	BMP51; BMP53



Highly reflective identification

Ideal for reading labels in low light conditions.

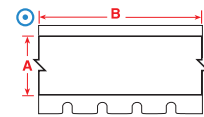

Diagram	Order Reference	Colour	Label Width A (mm)	Label Length B (m)	Labels per Roll	Printer Compatibility
B-584: Reflective Tape						
⊙	MC-500-584	Black on White	12.70	6.10	1	BMP41; BMP51; BMP53
⊙	MC-750-584	Black on White	19.05	6.10	1	BMP41; BMP51; BMP53
⊙	MC-1000-584	Black on White	25.40	6.10	1	BMP51; BMP53
⊙	MC-1500-584	Black on White	38.10	6.10	1	BMP51; BMP53
⊙	MC-500-584-YL	Black on Yellow	12.70	6.10	1	BMP41; BMP51; BMP53
⊙	MC-750-584-YL	Black on Yellow	19.05	6.10	1	BMP41; BMP51; BMP53
⊙	MC-1000-584-YL	Black on Yellow	25.40	6.10	1	BMP51; BMP53
⊙	MC-1500-584-YL	Black on Yellow	38.10	6.10	1	BMP51; BMP53



Name & rating plate labels for rough surfaces

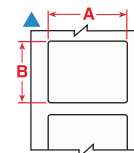

Diagram	Order Reference	Colour	Label Width A (mm)	Label Height B (mm)	Labels per Roll	Printer Compatibility
B-483: Polyester						
▲	M-61-483	Black on White	12.70	50.80	80	BMP41; BMP51; BMP53
▲	M-60-483	Black on White	25.40	50.80	140	BMP41; BMP51; BMP53
▲	M-47-483	Black on White	25.40	12.70	480	BMP41; BMP51; BMP53



Name & rating plate labels for smooth, high surface energy surfaces

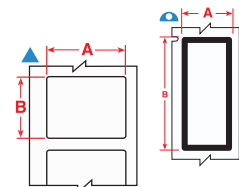

Diagram	Order Reference	Colour	Label Width A (mm)	Label Height B (mm)	Labels per Roll	Printer Compatibility
B-428: Metallised Polyester						
▲	M-92-428-BB	Black on Silver	12.70	33.02	239	BMP41; BMP51; BMP53
▲	M-47-428	Black on Silver	25.40	12.70	480	BMP41; BMP51; BMP53
▲	M-60-428	Black on Silver	25.40	50.80	140	BMP41; BMP51; BMP53
▲	M-30-428	Black on Silver	38.1	19.05	260	BMP51; BMP53
▲	M-29-428	Black on Silver	38.10	12.70	360	BMP51; BMP53

Asset & Component Marking

Name & rating plate labels for smooth, low surface energy & textured surfaces

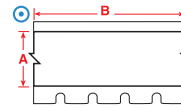
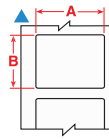

Diagram Reference	Order Reference	Colour	Label Width A (mm)	Label Length B (m)	Label Height B (mm)	Labels per Roll	Printer Compatibility
B-422: Polyester							
⊙	MC-375-422	Black on White	9.53	7.62		1	BMP41; BMP51; BMP53
⊙	MC-475-422	Black on White	12.07	7.62		1	BMP41; BMP51; BMP53
▲	M-89-422	Black on White	12.70		38.10	180	BMP41; BMP51; BMP53
▲	M-7-422	Black on White	12.70		12.70	280	BMP41; BMP51; BMP53
⊙	MC-500-422	Black on White	12.70	7.62		1	BMP41; BMP51; BMP53
⊙	MC-625-422	Black on White	15.88	7.62		1	BMP41; BMP51; BMP53
▲	M-90-422	Black on White	19.05		38.10	180	BMP41; BMP51; BMP53
▲	M-47-422	Black on White	25.40		12.70	480	BMP41; BMP51; BMP53
⊙	MC1-1000-422	Black on White	25.40	7.62		1	BMP41; BMP51; BMP53
▲	M-49-422	Black on White	25.40		25.40	260	BMP41; BMP51; BMP53
B-432: Polyester							
▲	M-17-432-CL-BK	Black on Clear	25.40		12.70	280	BMP51; BMP53
▲	M-78-432-CL-BK	Black on Clear	25.40		48.26	100	BMP51; BMP53
B-499: Nylon Cloth							
⊙	MC-375-499	Black on White	9.53	4.88		1	BMP41; BMP51; BMP53
⊙	MC-500-499	Black on White	12.70	4.88		1	BMP41; BMP51; BMP53
▲	M-11-499	Black on White	19.05		12.70	220	BMP41; BMP51; BMP53
⊙	MC-750-499	Black on White	19.05	4.88		1	BMP41; BMP51; BMP53
▲	M-84-499	Black on White	22.86		12.70	200	BMP51; BMP53
⊙	MC-1000-499	Black on White	25.40	4.88		1	BMP51; BMP53
▲	M-132-499	Black on White	38.10		31.75	160	BMP51; BMP53
B-595: Vinyl							
⊙	MC-500-595-CL-BK	Black on Clear	12.70	6.10		1	BMP41; BMP51; BMP53
⊙	MC-750-595-CL-BK	Black on Clear	19.05	6.10		1	BMP41; BMP51; BMP53
⊙	MC1-1000-595-CL-BK	Black on Clear	25.40	6.10		1	BMP41; BMP51; BMP53
⊙	MC-1500-595-CL-BK	Black on Clear	38.10	6.10		1	BMP51; BMP53
⊙	MC-500-595-OR-BK	Black on Orange	12.70	7.62		1	BMP41; BMP51; BMP53
⊙	MC-750-595-OR-BK	Black on Orange	19.05	7.62		1	BMP41; BMP51; BMP53
⊙	MC1-1000-595-OR-BK	Black on Orange	25.40	7.62		1	BMP41; BMP51; BMP53
⊙	MC-1500-595-OR-BK	Black on Orange	38.10	7.62		1	BMP51; BMP53
⊙	MC-375-595-WT-BK	Black on White	9.53	7.62		1	BMP41; BMP51; BMP53
⊙	MC-500-595-WT-BK	Black on White	12.70	7.62		1	BMP41; BMP51; BMP53
⊙	MC-750-595-WT-BK	Black on White	19.05	7.62		1	BMP41; BMP51; BMP53
⊙	MC1-1000-595-WT-BK	Black on White	25.40	7.62		1	BMP41; BMP51; BMP53
⊙	MC-1500-595-WT-BK	Black on White	38.10	7.62		1	BMP51; BMP53
⊙	MC-375-595-YL-BK	Black on Yellow	9.53	7.62		1	BMP41; BMP51; BMP53
⊙	MC-500-595-YL-BK	Black on Yellow	12.70	7.62		1	BMP41; BMP51; BMP53

Diagram Reference	Order Reference	Colour	Label Width A (mm)	Label Length B (m)	Label Height B (mm)	Labels per Roll	Printer Compatibility
B-595: Vinyl							
⊙	MC-750-595-YL-BK	Black on Yellow	19.05	7.62		1	BMP41; BMP51; BMP53
⊙	MC1-1000-595-YL-BK	Black on Yellow	25.40	7.62		1	BMP41; BMP51; BMP53
⊙	MC-1500-595-YL-BK	Black on Yellow	38.10	7.62		1	BMP51; BMP53
⊙	MC-500-595-WT-RD	Red on White	12.70	7.62		1	BMP41; BMP51; BMP53
⊙	MC-750-595-WT-RD	Red on White	19.05	7.62		1	BMP41; BMP51; BMP53
⊙	MC1-1000-595-WT-RD	Red on White	25.40	7.62		1	BMP41; BMP51; BMP53
⊙	MC-1500-595-WT-RD	Red on White	38.10	7.62		1	BMP51; BMP53
⊙	MC-500-595-BK-WT	White on Black	12.70	7.62		1	BMP41; BMP51; BMP53
⊙	MC-750-595-BK-WT	White on Black	19.05	7.62		1	BMP41; BMP51; BMP53
⊙	MC1-1000-595-BK-WT	White on Black	25.40	7.62		1	BMP41; BMP51; BMP53
⊙	MC-1500-595-BK-WT	White on Black	38.10	7.62		1	BMP51; BMP53
⊙	MC-500-595-BL-WT	White on Blue	12.70	7.62		1	BMP41; BMP51; BMP53
⊙	MC-750-595-BL-WT	White on Blue	19.05	7.62		1	BMP41; BMP51; BMP53
⊙	MC1-1000-595-BL-WT	White on Blue	25.40	7.62		1	BMP41; BMP51; BMP53
⊙	MC-1500-595-BL-WT	White on Blue	38.10	7.62		1	BMP51; BMP53
⊙	MC-500-595-CL-WT	White on Clear	12.70	6.10		1	BMP41; BMP51; BMP53
⊙	MC-750-595-CL-WT	White on Clear	19.05	6.10		1	BMP41; BMP51; BMP53
⊙	MC1-1000-595-CL-WT	White on Clear	25.40	6.10		1	BMP41; BMP51; BMP53
⊙	MC-1500-595-CL-WT	White on Clear	38.10	6.10		1	BMP51; BMP53
⊙	MC-500-595-GN-WT	White on Green	12.70	7.62		1	BMP41; BMP51; BMP53
⊙	MC-750-595-GN-WT	White on Green	19.05	7.62		1	BMP41; BMP51; BMP53
⊙	MC1-1000-595-GN-WT	White on Green	25.40	7.62		1	BMP41; BMP51; BMP53
⊙	MC-1500-595-GN-WT	White on Green	38.10	7.62		1	BMP51; BMP53
⊙	MC-375-595-RD-WT	White on Red	9.53	7.62		1	BMP41; BMP51; BMP53
⊙	MC-500-595-RD-WT	White on Red	12.70	7.62		1	BMP41; BMP51; BMP53
⊙	MC-750-595-RD-WT	White on Red	19.05	7.62		1	BMP41; BMP51; BMP53
⊙	MC1-1000-595-RD-WT	White on Red	25.40	7.62		1	BMP41; BMP51; BMP53
⊙	MC-1500-595-RD-WT	White on Red	38.10	7.62		1	BMP51; BMP53

Laboratory identification

Specimen tracking identification



Straw and rod labels

- Brady offers a range of labels designed to fit the small surface area of straws and rods and will withstand long-term storage.

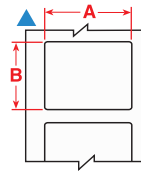
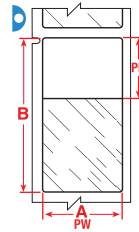

- F** Freezer environment
- N** Liquid nitrogen environment
- A** Autoclave environment
- H** Hot water bath (100°C)
- S** Self-laminating label
- L** Low-profile (extremely thin) label
- R** Removable

Labels are shown per straw size and in order of label width.

The background colours in the Order Reference column represent the material colour.

Diagram	Material	Special Properties	Label Width A (mm)	Label Height B (mm)	Printable Area Width PW (mm)	Printable Area Height PH (mm)	Order Reference	Printer Compatibility	Labels per Roll	Labels per Row
0.25 ml Straw										
▶	B-427	F N S	25.40	25.40	25.40	9.53	M-49-427	BMP51, BMP53	260	1
0.50 ml Straw										
▶	B-427	F N S	25.40	63.50	25.40	19.05	M-51-427	BMP51, BMP53	110	1
Straw Rod										
▲	B-427	F N S	27.94	6.35	27.94	6.35	M-135-427-AW	BMP51, BMP53	240	1
0.25 ml Straw										
▶	B-427	F N S	44.45	25.40	44.45	9.53	M-133-427	BMP51, BMP53	140	1
0.50 ml Straw										
▶	B-427	F N S	44.45	38.10	44.45	12.70	M-134-427	BMP51, BMP53	140	1

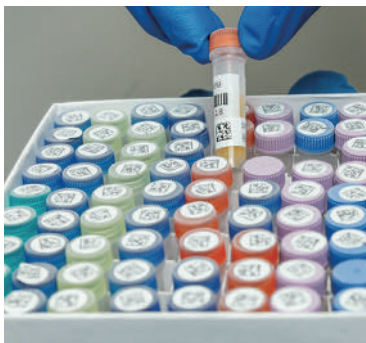

Vial / tube labels

- Brady's vial and test tube labels are designed to withstand extreme laboratory solvents like Xylene, Ethanol, Alcohol and DMSO, ensuring that the specimen identification is always legible - and will not smear, fade or fall off.

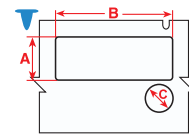
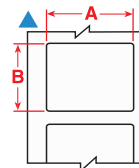
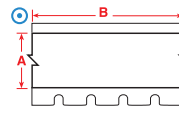
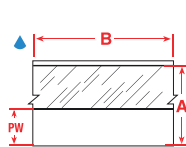

Labels are shown per vial / tube size and in order of label width.

The background colours in the Order Reference column represent the material colour.

Diagram	Material	Special Properties	Label Width A (mm)	Label Height B (mm)	Label Length B (m)	Diameter C (mm)	Printable Area Width PW (mm)	Order Reference	Printer Compatibility	Labels per Roll	Labels per Row
0.6 ml											
⊙	B-499	F N A	9.53	-	4.88	-	-	MC-375-499	BMP51, BMP53	1	1
1.0 - 8.0 ml											
▲	B-498	F	R 25.40	19.05	-	-	-	M-48-498	BMP51, BMP53	180	1
▲	B-492	F N H	44.45	25.40	-	-	-	M-125-492	BMP51, BMP53	180	1
1.5 - 2.0 ml											
▼	B-492	F H	41.28	15.24	-	9.53	-	M-95-492	BMP51, BMP53	200	1
▲	B-492	F N H	41.91	12.70	-	-	-	M-124-492	BMP51, BMP53	180	1
1.5 ml											
⊙	B-499	F N A	12.70	-	4.88	-	-	MC-500-499	BMP51, BMP53	1	1
2.0 - 50.0 ml											
⊙	B-499	F N A	19.05	-	4.88	-	-	MC-750-499	BMP51, BMP53	1	1
▲	B-427	F N S	19.05	-	7.62	-	9.53	MC-750-427	BMP51, BMP53	1	1
⊙	B-499	F N A	25.40	-	4.88	-	-	MC-1000-499	BMP51, BMP53	1	1
15.0 ml											
▲	B-7425	F N A H	38.10	25.40	-	-	38.10	M-31-7425	BMP51, BMP53	250	1
-											
⊗	B-7425	F N A H	25.40	9.53	-	9.53	25.40	M-118-7425	BMP51, BMP53	240	1

Specimen tracking identification

Vial Top Labels

Save time by using the Vial and Vial top combination labels
- print your information in one go.

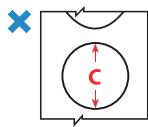
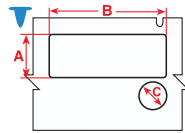
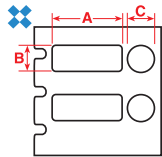

- F** Freezer environment
- A** Autoclave environment
- H** Hot water bath (100°C)
- S** Self-laminating label
- L** Low-profile (extremely thin) label
- R** Removable



Labels are shown per vial / tube size and in order of label width.

The background colours in the Order Reference column represent the material colour.

Diagram	Material	Special Properties	Label Width A (mm)	Label Height B (mm)	Diameter C (mm)	Order Reference	Printer Compatibility	Labels per Roll	Labels per Row
0.5 - 1.5 ml									
✕	B-499	F A	-	-	9.53	M-82-499	BMP51, BMP53	240	1
✕	B-499	F A	-	-	9.53	M-82-499-OR-BK	BMP51, BMP53	240	1
✕	B-499	F A	-	-	9.53	M-82-499-RD-BK	BMP51, BMP53	240	1
✕	B-499	F A	-	-	9.53	M-82-499-YL-BK	BMP51, BMP53	240	1
✕	B-492	F H L	-	-	9.53	M-82-492	BMP51, BMP53	240	1
1.0 - 2.0 ml									
✕✕	B-499	F A	25.40	9.53	9.53	M-118-499	BMP51, BMP53	240	1
✕✕	B-492	F H L	25.40	9.53	9.53	M-118-492	BMP51, BMP53	240	1
1.5 - 2.0 ml									
✕✕	B-499	F A	25.40	12.70	9.53	M-120-499	BMP51, BMP53	240	1
✕✕	B-492	F H L	25.40	12.70	9.53	M-120-492	BMP51, BMP53	240	1
✕✕	B-499	F A	25.40	12.70	11.18	M-117-499	BMP51, BMP53	240	1
✕✕	B-492	F H L	25.40	12.70	11.18	M-117-492	BMP51, BMP53	240	1
▽	B-492	F H L	41.28	15.24	9.53	M-95-492	BMP51, BMP53	200	1
✕	B-499	F A	-	-	12.70	M-83-499	BMP51, BMP53	240	1
✕	B-499	F A	-	-	12.70	M-83-499-OR-BK	BMP51, BMP53	240	1
✕	B-499	F A	-	-	12.70	M-83-499-RD-BK	BMP51, BMP53	240	1
✕	B-499	F A	-	-	12.70	M-83-499-YL-BK	BMP51, BMP53	240	1
✕	B-492	F H L	-	-	12.70	M-83-492	BMP51, BMP53	240	1
-									
✕✕	B-7425	F N A H	25.40	9.53	9.53	M-118-7425	BMP51, BMP53	240	1

Specimen tracking identification



Conical & large tube labeling

- Brady offers several sample identification labels which are perfect to identify conicals. They are easy to handle, have great flexibility and easily wrap around curved sample containers. Your sample identification label will remain attached and legible, even when the sample is stored in a freezer, in liquid nitrogen or heated in an autoclave.

- F** Freezer environment
- N** Liquid nitrogen environment
- A** Autoclave environment
- H** Hot water bath (100°C)
- S** Self-laminating label
- L** Low-profile (extremely thin) label
- R** Removable

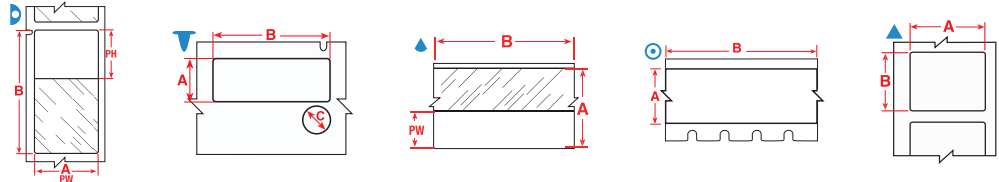

The background colours in the Order Reference column represent the material colour.

Labels are shown per vial / tube size and in order of label width.

Diagram	Material	Special Properties	Label Width A (mm)	Label Height B (mm)	Label Length B (m)	Diameter C (mm)	Printable Area Width PW (mm)	Printable Area Height PH (mm)	Order Reference	Printer Compatibility	Labels per Roll	Labels per Row
0.6 ml												
⊙	B-499	FNA	9.53	—	4.88	—	—	—	MC-375-499	BMP51, BMP53	1	1
1.0 - 8.0 ml												
▲	B-492	FNHL	44.45	25.40	—	—	—	—	M-125-492	BMP51, BMP53	180	1
1.0 - 15.0 ml												
▲	B-492	FNHL	22.86	25.40	—	—	—	—	M-156-492	BMP51, BMP53	180	1
1.5 - 2.0 ml												
▼	B-492	FHL	41.28	15.24	—	9.53	—	—	M-95-492	BMP51, BMP53	200	1
▲	B-492	FNHL	41.91	12.70	—	—	—	—	M-124-492	BMP51, BMP53	180	1
1.5 ml												
⊙	B-499	FNA	12.70	—	4.88	—	—	—	MC-500-499	BMP51, BMP53	1	1
2.0 - 50.0 ml												
⊙	B-499	FNA	19.05	—	4.88	—	—	—	MC-750-499	BMP51, BMP53	1	1
▲	B-427	FN S	19.05	—	7.62	—	9.53	—	MC-750-427	BMP51, BMP53	1	1
⊙	B-499	FNA	25.40	—	4.88	—	—	—	MC-1000-499	BMP51, BMP53	1	1
▲	B-427	FN S	25.40	—	7.62	—	9.53	—	MC-1000-427	BMP51, BMP53	1	1
⊙	B-461	FNAHSL	25.40	—	7.62	—	25.40	—	MC-1000-461-AW**	BMP51, BMP53	1	1
4.0 - 50.0 ml												
⊙	B-461	FNAHSL	31.75	—	7.62	—	31.75	—	MC-1250-461-AW**	BMP51, BMP53	1	1
5.0 - 50.0 ml												
▲	B-427	FN S	38.10	—	7.62	—	12.70	—	MC-1500-427	BMP51, BMP53	1	1
12.0 - 14.0 ml												
▶	B-461	FNAHSL	38.10	95.25	—	—	38.10	31.75	M-119-461	BMP51, BMP53	80	1
12.0 - 24.0 ml												
▲	B-492	FNHL	25.40	48.26	—	—	—	—	M-78-492	BMP51, BMP53	100	1
▲	B-499	FNA	38.10	31.75	—	—	—	—	M-132-499	BMP51, BMP53	160	1
14.0 - 15.0 ml												
▲	B-490	FNHL	38.10	55.88	—	—	—	—	M-113-490	BMP51, BMP53	140	1
▶	B-461	FNAHSL	38.10	57.15	—	—	38.10	31.75	M-129-461	BMP51, BMP53	140	1
▶	B-427	FN S	38.10	63.50	—	—	38.10	19.05	M-116-427	BMP51, BMP53	80	1
50.0 ml												
▶	B-427	FN S	19.05	38.10	—	—	19.05	12.70	M-90-427	BMP51, BMP53	180	1
▶	B-427	FN S	25.40	38.10	—	—	25.40	12.70	M-91-427	BMP51, BMP53	180	1
▲	B-499	FNA	25.40	48.26	—	—	—	—	M-128-499	BMP51, BMP53	100	1
▲	B-490	FNHL	38.10	98.42	—	—	—	—	M-114-490	BMP51, BMP53	80	1

*AW = All White / no transparent area.

Specimen process marking

Centrifuge / microcentrifuge labels

- Brady offers a wide range of Centrifuge, Eppendorf and PCR Labels. When applying a self-laminating label, we recommend you avoid touching the adhesive side of the label when wrapping it around a vial or tube, to ensure maximum adhesion.

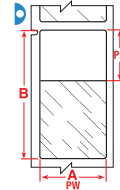
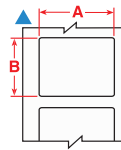
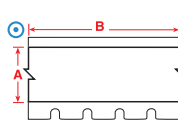
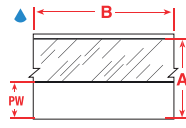
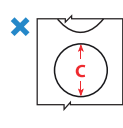
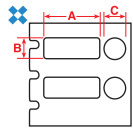

The background colours in the Order Reference column represent the material colour.

Labels are shown per vial / tube size and in order of label width.

Diagram	Material	Special Properties	Label Width A (mm)	Label Height B (mm)	Label Length B (m)	Diameter C (mm)	Printable Area Width PW (mm)	Printable Area Height PH (mm)	Order Reference	Printer Compatibility	Labels per Roll	Labels per Row
0.5 - 0.7 ml												
▶	B-461	FNAHSL	9.53	28.58	—	—	9.53	19.05	M-123-461	BMP51, BMP53	360	1
▶	B-461	FNAHSL	12.70	28.58	—	—	12.70	19.05	M-122-461	BMP51, BMP53	360	1
▶	B-461	FNAHSL	12.70	44.45	—	—	12.70	19.05	M-72-461	BMP51, BMP53	180	1
▲	B-499	FNA	19.05	12.70	—	—	—	—	M-11-499	BMP51, BMP53	220	1
▲	B-490	FN H L	31.75	9.53	—	—	—	—	M-112-490	BMP51, BMP53	360	1
▲	B-492	FN H L	31.75	9.53	—	—	—	—	M-112-492	BMP51, BMP53	360	1
0.5 - 1.5 ml												
✕	B-492	F H L	—	—	—	9.53	—	—	M-82-492	BMP51, BMP53	240	1
✕	B-499	F A	—	—	—	9.53	—	—	M-82-499-RD-BK	BMP51, BMP53	240	1
0.6 ml												
▲	B-492	FN H L	9.53	20.96	—	—	—	—	M-130-492	BMP51, BMP53	220	1
▲	B-499	FNA	9.53	20.96	—	—	—	—	M-130-499	BMP51, BMP53	220	1
⊙	B-499	FNA	9.53	—	4.88	—	—	—	MC-375-499	BMP51, BMP53	1	1
▲	B-499	FNA	22.86	12.70	—	—	—	—	M-84-499	BMP51, BMP53	200	1
▲	B-492	FN H L	31.75	6.35	—	—	—	—	M-155-492	BMP51, BMP53	180	1
1.0 - 2.0 ml												
✕	B-492	F H L	25.40	9.53	—	9.53	—	—	M-118-492	BMP51, BMP53	240	1
✕	B-499	F A	25.40	9.53	—	9.53	—	—	M-118-499	BMP51, BMP53	240	1
1.0 - 8.0 ml												
▲	B-492	FN H L	12.70	25.40	—	—	—	—	M-131-492	BMP51, BMP53	180	1
▲	B-499	FNA	12.70	25.40	—	—	—	—	M-131-499	BMP51, BMP53	180	1
▶	B-461	FNAHSL	12.70	55.88	—	—	12.70	19.05	M-74-461	BMP51, BMP53	140	1
▶	B-461	FNAHSL	15.24	45.72	—	—	15.24	25.40	M-126-461	BMP51, BMP53	180	1
▲	B-490	FN H L	15.24	45.72	—	—	—	—	M-126-490	BMP51, BMP53	180	1
▶	B-461	FNAHSL	15.24	66.68	—	—	15.24	25.40	M-86-461	BMP51, BMP53	120	1
1.5 - 2.0 ml												
▶	B-461	FNAHSL	12.70	41.91	—	—	12.70	19.05	M-124-461	BMP51, BMP53	180	1
▲	B-490	FN H L	12.70	41.91	—	—	—	—	M-124-490	BMP51, BMP53	180	1
✕	B-492	F H L	25.40	12.70	—	9.53	—	—	M-120-492	BMP51, BMP53	240	1
✕	B-499	F A	25.40	12.70	—	9.53	—	—	M-120-499	BMP51, BMP53	240	1
✕	B-492	F H L	25.40	12.70	—	11.18	—	—	M-117-492	BMP51, BMP53	240	1
✕	B-499	F A	25.40	12.70	—	11.18	—	—	M-117-499	BMP51, BMP53	240	1
▲	B-492	FN H L	41.91	12.70	—	—	—	—	M-124-492	BMP51, BMP53	180	1
✕	B-492	F H L	—	—	—	12.70	—	—	M-83-492	BMP51, BMP53	240	1
✕	B-499	F A	—	—	—	12.70	—	—	M-83-499-OR-BK	BMP51, BMP53	240	1
✕	B-499	F A	—	—	—	12.70	—	—	M-83-499-RD-BK	BMP51, BMP53	240	1
1.5 ml												
⊙	B-499	FNA	12.70	—	4.88	—	—	—	MC-500-499	BMP51, BMP53	1	1
⊙	B-461	FNAHSL	12.70	—	7.62	—	12.70	—	MC-500-461-AW	BMP51, BMP53	1	1
⊙	B-492	FN H L	12.70	—	7.62	—	—	—	MC-500-492	BMP51, BMP53	1	1
2.0 - 50.0 ml												
⊙	B-499	FNA	19.05	—	4.88	—	—	—	MC-750-499	BMP51, BMP53	1	1
▲	B-427	FN S	19.05	—	7.62	—	9.53	—	MC-750-427	BMP51, BMP53	1	1
⊙	B-499	FNA	25.40	—	4.88	—	—	—	MC-1000-499	BMP51, BMP53	1	1

Specimen process marking

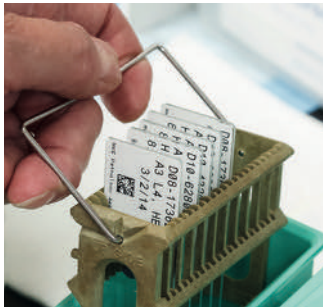

Slide labels

- Brady offers labels specifically designed to identify slides and to resist exposure to harsh chemicals during the slide staining process. They perform well in the hematoxylin and eosin slide staining process and offer superior chemical resistance also useful in other laboratory contexts.

- F** Freezer environment
- N** Liquid nitrogen environment
- A** Autoclave environment
- H** Hot water bath (100°C)
- S** Self-laminating label
- L** Low-profile (extremely thin) label
- R** Removable

Labels are shown in order of label width.

The background colours in the Order Reference column represent the material colour.

Diagram	Material	Special Properties	Label Width A (mm)	Label Height B (mm)	Order Reference	Printer Compatibility	Labels per Roll	Labels per Row
▲	B-488	F A	6.35	48.26	M-81-488	BMP51, BMP53	160	1
▲	B-481	F H	22.86	19.05	M-194-481	BMP51, BMP53	320	1
▲	B-488	F A	22.86	22.86	M-97-488	BMP51, BMP53	280	1
▲	B-481	F H	22.86	22.86	M-97-481	BMP51, BMP53	280	1
▲	B-481	F H	25.40	9.53	M-195-481	BMP51, BMP53	320	1
▲	B-7425	F N A H	38.10	25.40	M-31-7425	BMP51, BMP53	250	1

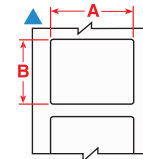

Tissue Cassette Labels

Specifically designed to identify tissue cassettes, Brady's B-482 label withstands a temperature range from -80°C to 121°C and offers superior resistance to chemicals used in tissue processing enabling it to retain barcode legibility. The label must be used in combination with Brady's BSP31 Label Attachment System for pre-process tissue cassette identification and complements the use of StainerBondz slide labels as part of a complete histology process.

- F** Freezer environment
- N** Liquid nitrogen environment
- A** Autoclave environment
- H** Hot water bath (100°C)
- S** Self-laminating label
- L** Low-profile (extremely thin) label
- R** Removable

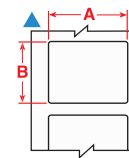

Labels are shown in order of label width.

The background colours in the Order Reference column represent the material colour.

Diagram	Material	Special Properties	Label Width A (mm)	Label Height B (mm)	Order Reference	Printer Compatibility	Labels per Roll	Labels per Row
▲	B-498	F R	19.05	12.70	M-11-498	BMP51, BMP53	220	1
▲	B-482	F H	26.67	6.35	M-127-482	BMP51, BMP53	360	1



B-498 Re-Identify Tissue Cassettes Labels

Tissue cassettes are often re-identified when labs collect samples from various biorepositories. Typically, each laboratory has its own unique way of identifying samples, which creates a need to re-identify samples in a common way.

Brady B-498 post-process labels offer customers the optimal way to organise these specimens and conduct further studies. These labels can be applied directly onto the cassettes, on pure paraffin wax and on top of another label or identifier.

This is not the same as Brady's B-482 tissue cassette solution. **B-498 Re-identify labels are applied after processing and are never used with the BSP31 label attachment system.**

Specimen storage Identification

- F** Freezer environment
- N** Liquid nitrogen environment
- A** Autoclave environment
- H** Hot water bath (100°C)
- S** Self-laminating label
- L** Low-profile (extremely thin) label
- R** Removable

Well plate labels

- When total tracking of all sample collections is required then Brady has a solution for Well plate identification. Our well plate labels guarantee crystal clear text and barcoding for most lab environments.

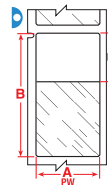
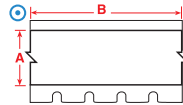
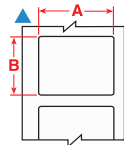
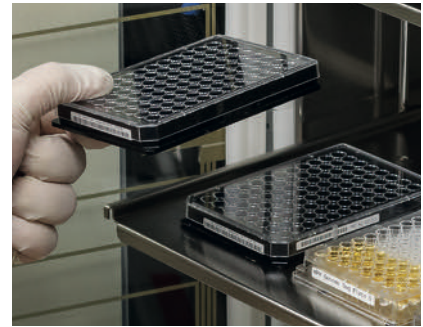

Labels are shown in order of label width.

The background colours in the Order Reference column represent the material colour.

Diagram	Material	Special Properties	Label Width A (mm)	Label Height B (mm)	Label Length B (m)	Printable Area Height PH (mm)	Printable Area Width PW (mm)	Order Reference	Printer Compatibility	Labels per Roll	Labels per Row
▲	B-488	F A	6.35	48.26	—	—	—	M-81-488	BMP51, BMP53	160	1
○	B-499	F N A	9.53	—	4.88	—	—	MC-375-499	BMP51, BMP53	1	1
○	B-595	F	9.53	—	7.62	—	—	MC-375-595-WT-BK	BMP51, BMP53	1	1
○	B-595	F	9.53	—	7.62	—	—	MC-375-595-YL-BK	BMP51, BMP53	1	1
○	B-499	F N A	12.70	—	4.88	—	—	MC-500-499	BMP51, BMP53	1	1
○	B-595	F	12.70	—	6.10	—	—	MC-500-595-CL-BK	BMP51, BMP53	1	1
○	B-595	F	12.70	—	6.10	—	—	MC-500-595-CL-WT	BMP51, BMP53	1	1
○	B-595	F	12.70	—	7.62	—	—	MC-500-595-BK-WT	BMP51, BMP53	1	1
○	B-595	F	12.70	—	7.62	—	—	MC-500-595-BL-WT	BMP51, BMP53	1	1
○	B-595	F	12.70	—	7.62	—	—	MC-500-595-GN-WT	BMP51, BMP53	1	1
○	B-595	F	12.70	—	7.62	—	—	MC-500-595-OR-BK	BMP51, BMP53	1	1
○	B-595	F	12.70	—	7.62	—	—	MC-500-595-RD-WT	BMP51, BMP53	1	1
○	B-595	F	12.70	—	7.62	—	—	MC-500-595-WT-BK	BMP51, BMP53	1	1
○	B-595	F	12.70	—	7.62	—	—	MC-500-595-WT-RD	BMP51, BMP53	1	1
○	B-595	F	12.70	—	7.62	—	—	MC-500-595-YL-BK	BMP51, BMP53	1	1
▷	B-427	F N S	19.05	38.10	—	12.70	19.05	M-90-427	BMP51, BMP53	180	1
○	B-499	F N A	19.05	—	4.88	—	—	MC-750-499	BMP51, BMP53	1	1
○	B-595	F	19.05	—	6.10	—	—	MC-750-595-CL-BK	BMP51, BMP53	1	1
○	B-595	F	19.05	—	6.10	—	—	MC-750-595-CL-WT	BMP51, BMP53	1	1
○	B-595	F	19.05	—	7.62	—	—	MC-750-595-BK-WT	BMP51, BMP53	1	1
○	B-595	F	19.05	—	7.62	—	—	MC-750-595-BL-WT	BMP51, BMP53	1	1
○	B-595	F	19.05	—	7.62	—	—	MC-750-595-GN-WT	BMP51, BMP53	1	1
○	B-595	F	19.05	—	7.62	—	—	MC-750-595-OR-BK	BMP51, BMP53	1	1
○	B-595	F	19.05	—	7.62	—	—	MC-750-595-RD-WT	BMP51, BMP53	1	1
○	B-595	F	19.05	—	7.62	—	—	MC-750-595-WT-BK	BMP51, BMP53	1	1
○	B-595	F	19.05	—	7.62	—	—	MC-750-595-WT-RD	BMP51, BMP53	1	1
○	B-595	F	19.05	—	7.62	—	—	MC-750-595-YL-BK	BMP51, BMP53	1	1
▲	B-432	F A	25.40	12.70	—	—	—	M-17-432-CL-BK	BMP51, BMP53	280	1
▷	B-427	F N S	25.40	38.10	—	12.70	25.40	M-91-427	BMP51, BMP53	180	1
○	B-499	F N A	25.40	—	4.88	—	—	MC-1000-499	BMP51, BMP53	1	1
○	B-595	F	25.40	—	6.10	—	—	MC1-1000-595-CL-BK	BMP51, BMP53	1	1
○	B-595	F	25.40	—	6.10	—	—	MC1-1000-595-CL-WT	BMP51, BMP53	1	1
○	B-595	F	25.40	—	7.62	—	—	MC1-1000-595-BK-WT	BMP51, BMP53	1	1
○	B-595	F	25.40	—	7.62	—	—	MC1-1000-595-BL-WT	BMP51, BMP53	1	1
○	B-595	F	25.40	—	7.62	—	—	MC1-1000-595-GN-WT	BMP51, BMP53	1	1
○	B-595	F	25.40	—	7.62	—	—	MC1-1000-595-OR-BK	BMP51, BMP53	1	1
○	B-595	F	25.40	—	7.62	—	—	MC1-1000-595-RD-WT	BMP51, BMP53	1	1
○	B-595	F	25.40	—	7.62	—	—	MC1-1000-595-WT-BK	BMP51, BMP53	1	1
○	B-595	F	25.40	—	7.62	—	—	MC1-1000-595-WT-RD	BMP51, BMP53	1	1
○	B-595	F	25.40	—	7.62	—	—	MC1-1000-595-YL-BK	BMP51, BMP53	1	1

Specimen storage identification



Cryo preservation

- Brady offers a range of labels designed specifically to identify laboratory samples for cryo storage. These labels can be applied to room temperature or to already frozen samples, albeit with a small overlap. The label will remain legible and will stick to the sample container during processing, even when exposed to extreme heat or chemicals like DMSO, Xylene and Ethanol, ensuring secure sample identification in the most challenging laboratory conditions.

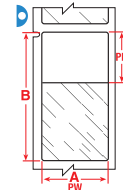
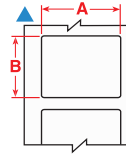
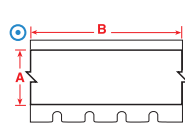

The background colours in the Order Reference column represent the material colour.

Labels are shown per vial / tube size and in order of label width.

Diagram	Material	Special Properties	Label Width A (mm)	Label Height B (mm)	Label Length B (m)	Printable Area Width PW (mm)	Printable Area Height PH (mm)	Order Reference	Printer Compatibility	Labels per Roll	Labels per Row
0.5 - 0.7 ml											
▶	B-461	FNAHSL	9.53	28.58	—	9.53	19.05	M-123-461	BMP51, BMP53	360	1
▶	B-461	FNAHSL	12.70	28.58	—	12.70	19.05	M-122-461	BMP51, BMP53	360	1
▶	B-461	FNAHSL	12.70	44.45	—	12.70	19.05	M-72-461	BMP51, BMP53	180	1
▲	B-499	FNA	19.05	12.70	—	—	—	M-11-499	BMP51, BMP53	220	1
▲	B-490	FNHL	31.75	9.53	—	—	—	M-112-490	BMP51, BMP53	360	1
0.6 ml											
▲	B-499	FNA	9.53	20.96	—	—	—	M-130-499	BMP51, BMP53	220	1
▲	B-492	FNHL	9.53	20.96	—	—	—	M-130-492	BMP51, BMP53	220	1
○	B-499	FNA	9.53	—	4.88	—	—	MC-375-499	BMP51, BMP53	1	1
○	B-461	FNAHSL	9.53	—	7.62	9.53	—	MC-375-461-AW	BMP51, BMP53	1	1
▲	B-499	FNA	22.86	12.70	—	—	—	M-84-499	BMP51, BMP53	200	1
1.0 - 8.0 ml											
▲	B-499	FNA	12.70	25.40	—	—	—	M-131-499	BMP51, BMP53	180	1
▲	B-492	FNHL	12.70	25.40	—	—	—	M-131-492	BMP51, BMP53	180	1
▶	B-461	FNAHSL	12.70	55.88	—	12.70	19.05	M-74-461	BMP51, BMP53	140	1
▶	B-461	FNAHSL	15.24	45.72	—	15.24	25.40	M-126-461	BMP51, BMP53	180	1
▲	B-490	FNHL	15.24	45.72	—	—	—	M-126-490	BMP51, BMP53	180	1
▶	B-461	FNAHSL	15.24	66.68	—	15.24	25.40	M-86-461	BMP51, BMP53	120	1
▶	B-461	FNAHSL	25.40	44.45	—	25.40	25.40	M-125-461	BMP51, BMP53	180	1
▲	B-490	FNHL	25.40	44.45	—	—	—	M-125-490	BMP51, BMP53	180	1
▶	B-461	FNAHSL	25.40	66.68	—	25.40	25.40	M-75-461	BMP51, BMP53	120	1
1.0 - 15.0 ml											
▲	B-492	FNHL	22.86	25.40	—	—	—	M-156-492	BMP51, BMP53	180	1
1.5 ml											
○	B-499	FNA	12.70	—	4.88	—	—	MC-500-499	BMP51, BMP53	1	1
○	B-461	FNAHSL	12.70	—	7.62	12.70	—	MC-500-461-AW	BMP51, BMP53	1	1
2.0 - 50.0 ml											
○	B-499	FNA	19.05	—	4.88	—	—	MC-750-499	BMP51, BMP53	1	1
○	B-499	FNA	25.40	—	4.88	—	—	MC-1000-499	BMP51, BMP53	1	1
○	B-461	FNAHSL	25.40	—	7.62	25.40	—	MC-1000-461-AW	BMP51, BMP53	1	1
4.0 - 50.0 ml											
○	B-461	FNAHSL	31.75	—	7.62	31.75	—	MC-1250-461-AW	BMP51, BMP53	1	1
12.0 - 14.0 ml											
▶	B-461	FNAHSL	38.10	95.25	—	38.10	31.75	M-119-461	BMP51, BMP53	80	1
12.0 - 24.0 ml											
▲	B-492	FNHL	25.40	48.26	—	—	—	M-78-492	BMP51, BMP53	100	1
▲	B-499	FNA	38.10	31.75	—	—	—	M-132-499	BMP51, BMP53	160	1

Lean lab identification

Bottles / flasks & dishes

- Brady's labels for bottles, flasks and dishes are easy to handle and flexible. This enables the labels to be placed on curved containers and remain attached and legible, even after being subjected to freezing, liquid nitrogen and heat.

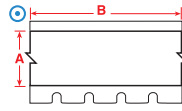
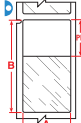
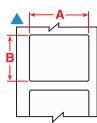

Labels are shown in order of label width.

The background colours in the Order Reference column represent the material colour.

Diagram	Material	Special Properties	Label Width A (mm)	Label Height B (mm)	Label Length B (m)	Printable Area Width PW (mm)	Printable Area Height PH (mm)	Order Reference	Printer Compatibility	Labels per Roll	Labels per Row
▲	B-499	FNA	9.53	20.96	—	—	—	M-130-499	BMP51, BMP53	220	1
○	B-499	FNA	9.53	—	4.88	—	—	MC-375-499	BMP51, BMP53	1	1
▲	B-499	FNA	12.70	25.40	—	—	—	M-131-499	BMP51, BMP53	180	1
▲	B-498	F R	12.70	25.40	—	—	—	M-131-498	BMP51, BMP53	180	1
○	B-499	FNA	12.70	—	4.88	—	—	MC-500-499	BMP51, BMP53	1	1
▶	B-427	FN S	19.05	38.10	—	19.05	12.70	M-90-427	BMP51, BMP53	180	1
○	B-499	FNA	19.05	—	4.88	—	—	MC-750-499	BMP51, BMP53	1	1
▲	B-498	F R	25.40	31.75	—	—	—	M-103-498	BMP51, BMP53	160	1
▶	B-427	FN S	25.40	38.10	—	25.40	12.70	M-91-427	BMP51, BMP53	180	1
▶	B-498	F R	25.40	48.26	—	—	—	M-128-498	BMP51, BMP53	100	1
○	B-499	FNA	25.40	—	4.88	—	—	MC-1000-499	BMP51, BMP53	1	1
▲	B-499	FNA	38.10	31.75	—	—	—	M-132-499	BMP51, BMP53	160	1

Water dissolvable labels

The B-403 water dissolvable paper label is self-adhesive and extremely easy to apply. Exposing the label to warm water will completely dissolve it within 30 seconds, without damage to the surface it was applied to, and without leaving any residue. The water dissolvable label adheres well to most surfaces, including glass, stainless steel, aluminium, plastic and others. This makes the label a great solution to enable short term identification for containers, crates and glassware with a minimum of waste.



The background colours in the Order Reference column represent the material colour.

Diagram	Material	Special Properties	Label Width A (mm)	Label Length B (m)	Order Reference	Printer Compatibility	Ribbon Series	Labels per Roll
○	B-403	R	19.05	7.62	MC-750-403	BMP41; BMP51; BMP53	M61-R4300	1
○	B-403	R	38.10	7.62	MC-1500-403	BMP51; BMP53	M61-R4310	1

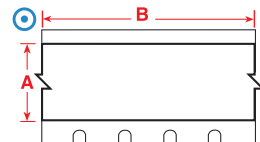

Bottle tamper seal labels

Brady's bottle seal identification provides tracking information with the added feature of security. These labelling materials are designed to fracture easily in order to show signs of sample tampering and to prevent one-piece label removal.

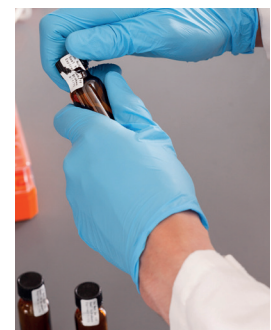
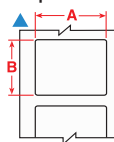

Labels are shown in order of label width.

The background colours in the Order Reference column represent the material colour.

Diagram	Material	Special Properties	Label Width A (mm)	Label Height B (mm)	Order Reference	Printer Compatibility	Labels per Roll	Labels per Row
▲	B-351	F	25.40	12.70	M-17-351	BMP51, BMP53	360	1
▲	B-351	F	25.40	50.80	M-20-351	BMP51, BMP53	160	1

Lean lab identification



General lab identification

Just like a durable sample label lets you know which sample you are holding, a cabinet or drawer label can inform you of the cabinet's content. With proper identification, time spent looking for the right sample or tool can be invested in what really matters. Brady offers a range of materials suitable for identifying drawers, cabinets, shelves, storage units and laboratory equipment.

- F** Freezer environment
- N** Liquid nitrogen environment
- A** Autoclave environment
- H** Hot water bath (100°C)
- S** Self-laminating label
- L** Low-profile (extremely thin) label
- R** Removable

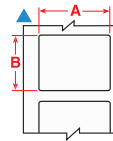
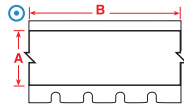

Labels are shown in order of label width.

The background colours in the Order Reference column represent the material colour

Diagram	Material	Special Properties	Label Width A (mm)	Label Height B (mm)	Label Length B (m)	Order Reference	Printer Compatibility	Labels per Roll	Labels per Row
▲	B-499	F N A	9.53	20.96	—	M-130-499	BMP51, BMP53	220	1
○	B-499	F N A	9.53	—	4.88	MC-375-499	BMP51, BMP53	1	1
○	B-595	F	9.53	—	7.62	MC-375-595-WT-BK	BMP51, BMP53	1	1
○	B-595	F	9.53	—	7.62	MC-375-595-YL-BK	BMP51, BMP53	1	1
▲	B-499	F N A	12.70	25.40	—	M-131-499	BMP51, BMP53	180	1
▲	B-498	F R	12.70	25.40	—	M-131-498	BMP51, BMP53	180	1
○	B-499	F N A	12.70	—	4.88	MC-500-499	BMP51, BMP53	1	1
○	B-595	F	12.70	—	6.10	MC-500-595-CL-BK	BMP51, BMP53	1	1
○	B-595	F	12.70	—	6.10	MC-500-595-CL-WT	BMP51, BMP53	1	1
○	B-595	F	12.70	—	7.62	MC-500-595-BK-WT	BMP51, BMP53	1	1
○	B-595	F	12.70	—	7.62	MC-500-595-BL-WT	BMP51, BMP53	1	1
○	B-595	F	12.70	—	7.62	MC-500-595-GN-WT	BMP51, BMP53	1	1
○	B-595	F	12.70	—	7.62	MC-500-595-OR-BK	BMP51, BMP53	1	1
○	B-595	F	12.70	—	7.62	MC-500-595-RD-WT	BMP51, BMP53	1	1
○	B-595	F	12.70	—	7.62	MC-500-595-WT-BK	BMP51, BMP53	1	1
○	B-595	F	12.70	—	7.62	MC-500-595-WT-RD	BMP51, BMP53	1	1
○	B-595	F	12.70	—	7.62	MC-500-595-YL-BK	BMP51, BMP53	1	1
○	B-499	F N A	19.05	—	4.88	MC-750-499	BMP51, BMP53	1	1
○	B-595	F	19.05	—	6.10	MC-750-595-CL-BK	BMP51, BMP53	1	1
○	B-595	F	19.05	—	6.10	MC-750-595-CL-WT	BMP51, BMP53	1	1
○	B-595	F	19.05	—	7.62	MC-750-595-BK-WT	BMP51, BMP53	1	1
○	B-595	F	19.05	—	7.62	MC-750-595-BL-WT	BMP51, BMP53	1	1
○	B-595	F	19.05	—	7.62	MC-750-595-GN-WT	BMP51, BMP53	1	1
○	B-595	F	19.05	—	7.62	MC-750-595-OR-BK	BMP51, BMP53	1	1
○	B-595	F	19.05	—	7.62	MC-750-595-RD-WT	BMP51, BMP53	1	1
○	B-595	F	19.05	—	7.62	MC-750-595-WT-BK	BMP51, BMP53	1	1
○	B-595	F	19.05	—	7.62	MC-750-595-WT-RD	BMP51, BMP53	1	1
○	B-595	F	19.05	—	7.62	MC-750-595-YL-BK	BMP51, BMP53	1	1
▲	B-432	F A	25.40	12.70	—	M-17-432-CL-BK	BMP51, BMP53	280	1
▲	B-498	F R	25.40	31.75	—	M-103-498	BMP51, BMP53	160	1
▲	B-498	F R	25.40	48.26	—	M-128-498	BMP51, BMP53	100	1
▲	B-432	F N A	25.40	48.26	—	M-78-432-CL-BK	BMP51, BMP53	100	1
○	B-499	F N A	25.40	—	4.88	MC-1000-499	BMP51, BMP53	1	1
○	B-595	F	25.40	—	6.10	MC1-1000-595-CL-BK	BMP51, BMP53	1	1
○	B-595	F	25.40	—	6.10	MC1-1000-595-CL-WT	BMP51, BMP53	1	1
○	B-595	F	25.40	—	7.62	MC1-1000-595-BK-WT	BMP51, BMP53	1	1
○	B-595	F	25.40	—	7.62	MC1-1000-595-BL-WT	BMP51, BMP53	1	1
○	B-595	F	25.40	—	7.62	MC1-1000-595-GN-WT	BMP51, BMP53	1	1
○	B-595	F	25.40	—	7.62	MC1-1000-595-OR-BK	BMP51, BMP53	1	1
○	B-595	F	25.40	—	7.62	MC1-1000-595-RD-WT	BMP51, BMP53	1	1
○	B-595	F	25.40	—	7.62	MC1-1000-595-WT-BK	BMP51, BMP53	1	1
○	B-595	F	25.40	—	7.62	MC1-1000-595-WT-RD	BMP51, BMP53	1	1
○	B-595	F	25.40	—	7.62	MC1-1000-595-YL-BK	BMP51, BMP53	1	1
▲	B-499	F N A	38.10	31.75	—	M-132-499	BMP51, BMP53	160	1

This section provides a quick reference to Brady materials listed throughout this catalogue, including basic attributes, applications and regulatory compliance where applicable. For more detailed material attribute and performance information, please refer to the material's Technical Data Sheet, listed at www.bradyeurope.com/tds.

Brady Material No.	Material	Finish	Colour	Temp (°C) (Tested for 30 days)		Performance Attributes	Properties & Applications	Approval/Compliance
				Min.	Max.			
B-109	Polyethylene Tag	Matt	White	-40 °C	49 °C		White polyethylene tag material with matt finish. Excellent multi-purpose tag for identifying multiconductor cables, inventory, safety warning repair and work-in-processing manufacturing. Good weatherability, humidity resistance and legibility after solvent exposure.	–
B-145	Polyethylene Tag	Matt	Grey	-40 °C	100 °C		This multipurpose material can be used for a variety of tag applications including identification of multiconductor cables, equipment, safety warning repair and work-in-progress.	–
B-342	Heat-shrink Polyolefin Sleeve	Matt	White	-55 °C	130.6 °C		3:1 ratio heat shrinkable wire marking sleeve that fits snugly around wires for identification and protection. Fade-resistant and flame retardant. Also available in yellow, black, blue, brown, green, gray, orange, pink, red, violet.	UL Recognised to UL224; SAE-AMS-DTL-23053/5 C (Class 1); SAE-AS-81531
B-351	Tamper-resistant Vinyl	Matt	White	-40 °C	80 °C		White vinyl material with matt finish. Tamper evident material fractures to show signs of product tampering and prevent one-piece removal.	–
B-403	Paper	Matt	Black on White	-40 °C	78 °C		White dissolvable paper. Dissolves completely in water leaving no adhesive residue, ideal for temporary labeling applications.	–
B-412	Polypropylene Tag	Matt	White	-40 °C	100 °C		White polypropylene tag material with matt finish. Offers high print legibility and high tensile strength.	–
B-422	Polyester	Gloss	White	-40 °C	100 °C		White material stock with glossy finish and 2 mils of adhesive for rough surface applications, including low surface energy plastics. Designed to withstand solvent exposure. UL rated for surfaces commonly used in solar panel manufacturing. Also used for component identification, barcoding, asset and inventory tracking.	UL Recognised; CSA Accepted
B-425	Polypropylene	Matt	White	-70 °C	80 °C		White polypropylene material stock with matt finish for thermal transfer printing or write-on applications. Excellent solvent resistance and print performance; not recommended for long-term outdoor use.	UL Recognised; CSA Accepted; Halogen Free (DIN VDE 0472/part 815)
B-427	Self-laminating Vinyl	Matt	White/Transparent	-40 °C	60 °C		Thermal transfer printable, self-laminating material. These labels have a printable area with a clear "tail" that wraps around the marker. The "tail" serves as overlamine to protect the print. Superior resistance to abrasion, solvents, water, oil and dirt. Also available in grey, brown, green, yellow, blue, red, purple, orange	UL Recognised to UL969 Labelling and Marking Standard when printed with the Brady Series R4300 and R6200 ribbons. See UL files MH17154 for specific details. Brady customers should specify at purchase if they require UL Recognised B-427 labels and non-approved labels depending on customer requirements.
B-428	Metallised Polyester	Matt	Silver	-70 °C	120 °C		Thermal transfer printable metallised polyester with matt finish. Withstands solvents and variable temperatures. Excellent for serial and rating plate applications with name-plate quality and a metal-looking finish.	UL Recognised; CSA Accepted; Halogen Free (DIN VDE 0472/part 815)
B-432	Polyester	Gloss	Clear	-40 °C	100 °C		Translucent, high performance polyester material with a glossy finish. Thermal transfer printable. Very similar to B-430, but has a thicker layer of acrylic adhesive for better adherence to rough surface applications.	UL Recognised; CSA Accepted
B-461	Self-laminating Polyester	Matt	White/Transparent	-196 °C	110 °C		Permanent adhesive; suitable for liquid nitrogen application if material is wrapped around itself, as in self-lamination; write-on capabilities. Temperature range increases to 121 °C when used in autoclave process	–
B-7425	Polypropylene	Matt	Black on White	-80 °C	70 °C		White Polypropylene material. Ideal for laboratory identification such as vials, centrifuge tubes and test tubes. For freezer or liquid nitrogen applications, B-7425 must be applied prior to being frozen.	–

Master material index

Brady Material No.	Material	Finish	Colour	Temp (°C) (Tested for 30 days) Min. Max.		Performance Attributes	Properties & Applications	Approval/Compliance
B-481	StainerBondz™ Polyester	Matt	White	-80 °C	130 °C		White polyester will remain resistant when exposed to xylene and other chemicals that are commonly used in the slide staining process	–
B-482	Polyester	Matt	White				The B-482 label material, combined with Brady's R6400 ribbon, provides the durability and print quality that histology and anatomic pathology labs need for accurate, identifiable specimen labelling. Paraffin and solvent resistant.	–
B-483	Polyester	Gloss	White	-40 °C	120 °C		White polyester thermal transfer printable material with glossy finish and aggressive adhesive specifically designed for powder coated surfaces.	UL Recognised; CSA Accepted
B-488	Polyester	Matt	White	-40 °C	145 °C		White polyester thermal transfer printable material, similar to B-423, but with matt finish. Widely used for component identification, barcoding, asset and inventory tracking.	UL Recognised; CSA Accepted
B-490	Freezerbondz™ Polyester	Matt	White	-196 °C	130 °C		Can be applied to frozen surfaces including glass and polypropylene stored in liquid nitrogen, except for Vial Tops. Material must slightly overlap itself.	–
B-492	Freezerbondz™ Polyester	Matt	White	-196 °C	110 °C		Ultra thin; can label frosted/frozen (with overlap) or room temperature labels and lasts in liquid nitrogen and hot water baths	–
B-498	Vinyl Cloth	Semi-gloss	White	-40 °C	80 °C		White vinyl cloth label material with glossy finish. The adhesive and cloth backing give excellent holding power, while being repositionable and removing cleanly.	UL Recognised
B-499	Nylon Cloth	Matt	White	-40 °C	90 °C		Nylon cloth material with matt finish. The adhesive allows labelling in environments with heat, cold, oil and dirt. Also available in orange, red and yellow.	UL Recognised; CSA Accepted; Halogen Free (DIN VDE 0472/part 815) Approvals are for White material only
B-584	Reflective Tape	Gloss	Orange	-40 °C	70 °C		Suitable for outdoor use. Also available in silver and yellow.	–
B-595	Vinyl	Gloss	White	-40 °C	82 °C		Durable, low-shrink vinyl with our most aggressive adhesive. Conforms to irregular, curved, rough and highly textured surfaces (painted cinder blocks, uneven wood, textured plastics, paper-jacketed pipes, powder-coated surfaces). Adheres to "difficult" low-surface energy items (PVC piping, blow-moulded equipment cases, ABS plastics, recycled plastics). Available in a wide range of colours.	BS5609:1986 Section 2 and section 3
B-7641	Heat-shrink Polyolefin Sleeve	Matt	White	-55 °C	105 °C		2:1 ratio heat shrinkable, zero halogen wire marking sleeves. The wire marking sleeves offer outstanding fire safety properties and minimal smoke emission. Also available in yellow.	BS-6853 (1999) Vehicle Category 1A; EN-45545-2, requirement 24, Vehicle Category HL3; Zero Halogen



WorkHorse™ Labels



MetaLabel™ Series



ToughBond™ Series



Defender™ Series



CleanLift™ Series



UltraTemp™ Series



Abrasion resistance



Electrostatic dissipative



Fuel/oil resistance



High heat resistance



Low temperature resistance



Removable



Solvent/chemical resistance



Tamper-indicating



Ultra-aggressive adhesive

Brady Workstation

Brady Workstation offers professional, intuitive apps to design quality product and cable labels and safety signs. Label design becomes easier, faster and quickly adaptable to new label norms thanks to centralised updates.

Select the apps you need

Simply select the apps you need, download the 30-day trial and purchase when satisfied. Available product, cable, safety and facility identification apps enable you to:

- design and edit custom labels and signs
- design label templates and lock elements for consistency
- create text-only cable labels
- automate label creation
- easily import data
- easily set up complex label sequences
- easily design CLP-chemical labels
- print lockout procedures, tags and energy source labels
- design safety and facility signs.

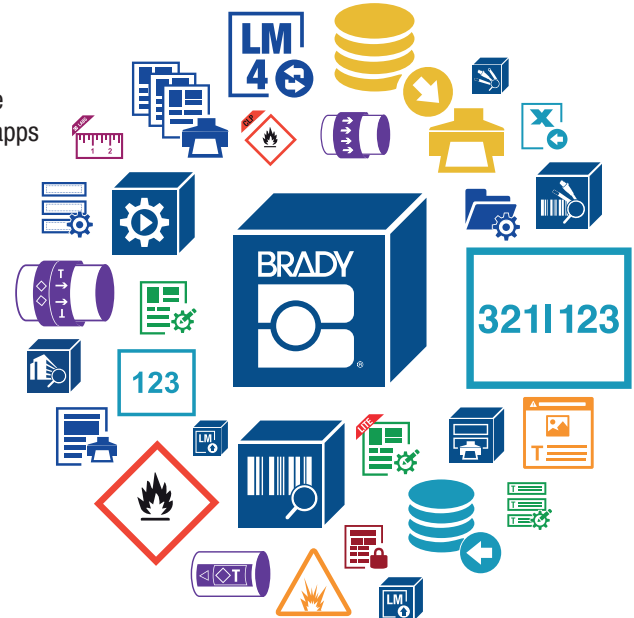

Available in multiple languages

Brady Workstation apps are available in more than 20 languages, including English, French, German, Russian, Spanish, Italian, Polish and Dutch. Select your language before downloading from the drop down menu.

Easily connect to your printer

Brady Workstation works seamlessly with a range of Brady desktop and portable printers. Brady's high-end label printers also offer bi-directional communication with Brady Workstation and will inform users if they have to switch label materials to print specific label designs. Printer compatibility is shown in Brady Workstation on an app by app basis.

Try it today! Discover Brady Workstation at www.bradyeurope.com/workstation or download at workstation.bradyid.com.



Suite du logiciel Conception de base de Brady Workstation

Rendez vos ressources internes rapidement opérationnelles sur autant d'ordinateurs que vous le souhaitez grâce à ce logiciel gratuit de création d'étiquettes ! Vous bénéficierez d'une conception de base, d'une fonctionnalité de mise en forme, d'illustrations et de bibliothèques de codes-barres simples pour créer des étiquettes de qualité professionnelle !

Cette suite de base est fournie avec chaque imprimante. Il vous suffit de la télécharger. Workstation.BradyID.com/Free



Suite du logiciel Identification de produits et fils de Brady Workstation

Identifiez rapidement vos produits et fils à l'aide d'étiquettes de texte ou illustrées personnalisées, en utilisant des données sérialisées ou importées. Workstation.BradyID.com/ProductandWire

Printer specifications

PRINTER	
Description	BMP51 Label Printer
Includes	This printer ships in a hard case with a Rechargeable Lithium Ion Battery, USB Cable, AC adaptor, power cord, Product CD, Brady Printer Drivers CD, Quick Start Guide, a Bluetooth network card and an MC1-1000-422 cartridge.
Applications	Wire & Cable Marking; Patch Panel Identification; Control Panel & Component Marking; Terminal Block Marking; Voice & Data Communication; Electrical Component Marking; General & Industrial Marking; Laboratory Identification
Print Speed (mm/sec)	25.40
Internal Memory Capacity	48 MB - up to 25,000 labels
Cutter	Manual cut Between labels or at end of print job With label retention
Keyboard Type	QWERTY
Colour Capability	Monocolour
Language Support	Danish, Dutch, English, Finnish, French, German, Italian, Norwegian (Bokmål), Portuguese, Spanish, Swedish
Portability	Yes
Weight (kg)	1.20
Size W x D x L (mm)	107 x 106 x 328
Drop Test	up to 1.8 metres
Operating Temperature	5°C - 40°C
Operating Humidity	20%-90% (non-condensing)
Warranty	2 years

MEDIA SUPPORTED	
Materials Supported	200+ standard parts: continuous tapes and die cut labels
Format	Media supplied in Cartridge with Ribbon
Compatible Media	M-, MC-, MC1-
Continuous vs Die-cut Labels	Continuous Tape & Die Cut Labels
Custom Labels	No
Smart Cell	Yes
Calibration	Automated through Smart Cell
Max. Label Width (mm)	38.10 mm
Min. Label Width (mm)	6.40 mm
Recommended Usage per Day	500

POWER SUPPLY	
Auto Shut Off	Yes
Battery Type	Lithium Ion Battery
Power Supply	AC Adaptor, 8 AA Batteries, Rechargeable Battery

FONTS/GRAPHICS/SYMBOLOLOGIES	
Text Sizes (pt)	4 - 102 pt
Built-in Fonts	Brady Alpine Brady Fixed Width
Built-in Symbols	450 symbols included
Symbol Categories	Arrows Electrical Exit Datacom Fire Safety First Aid GHS/CLP Laboratory Mandatory Packaging Miscellaneous Personal Protective Equipment Prohibition Public Information Safety Warning WHIMIS
Bar Code Capability	Yes
Bar Code Type	Code 39 and 128, other via software

DISPLAY	
Display	Monocolour LCD Screen
Display Resolution	320 x 240 px
Display Size	68.58 mm x 43.18 mm

PRINTING FUNCTIONS	
Printing Functions	Banner Serialisation Mirror Rotate Reverse Auto Format Justification Vertical Fixed Length Multi-copy Print Preview Date/Time Stamp Frame Feature
Serialisation	Simple & Simultaneous & Single Advanced & Multiple Advanced
Printing Modes	Flags Terminal Block Patch Panel Wire Wrap
Print Resolution (dpi)	300

SOFTWARE & CONNECTIVITY	
Connectivity Options	USB, Bluetooth. Optional: Ethernet, WiFi
Software Compatibility	Brady Workstation, LabelMark, CodeSoft

COMPLIANCE	
Approval/Compliance	CE, WEEE, RoHS

Printers

Order Reference	Art. No.	Description
BMP51 PRINTER EU	710894	BMP51 Label Printer - EU
BMP51-EU-PWID	198630	BMP51 Label Printer - EU with Brady Workstation PWID Suite
BMP51 PRINTER KIT UK	710898	BMP51 Label Printer - UK
BMP51-UK-PWID	198631	BMP51 Label Printer - UK with Brady Workstation PWID Suite



The Basic Suite is included with every printer, all you need to do is download it. Workstation.BradyID.com/Free



Quickly identify your products and wires with customised text or graphical labels, using serialised or imported data. Workstation.BradyID.com/ProductandWire



Printer Kits

Order Reference	Art. No.	Description
BMP51-EU-ELEC*	198654	BMP51 Electrical Kit EU
BMP51-UK-ELEC*	198657	BMP51 Electrical Kit UK
BMP51-EU-LAB***	198655	BMP51 Laboratory Kit EU
BMP51-UK-LAB***	198658	BMP51 Laboratory Kit UK
BMP51-EU-DATA**	198653	BMP51 TeleDatacom Kit EU
BMP51-UK-DATA**	198656	BMP51 TeleDatacom Kit UK

*Freezerbondz Polyester; Heat-shrink Polyolefin Sleeve; Metallised Polyester; Nylon Cloth; Polyester; Polyethylene Tag; Polypropylene; Polypropylene Tag; Reflective Tape; Self-laminating Polyester; Self-laminating Vinyl; StainerBondz Polyester; Tamper-resistant Vinyl; Vinyl; Vinyl Cloth

**This printer ships in a hard case with a Rechargeable Lithium Ion Battery, USB Cable, AC adaptor with power cord, Magnet accessory, Product CD, Brady Printer Drivers CD, Quick Start Guide, a Bluetooth network card, a Brady Workstation Product & Wire Identification Suite, M-132-499, M1-115-427 and an MC1-1000-422 cartridge.

***This printer ships in a hard case with a Rechargeable Lithium Ion Battery, USB Cable, AC adaptor with power cord, Product CD, Brady Printer Drivers CD, Quick Start Guide, a Bluetooth network card, a Brady Workstation Product & Wire Identification Suite, M-122-461, M-131-499 and an MC1-1000-422 cartridge.



Accessories

Art. No.	Order Reference	Description
142261	UBP-Li-ION-AC-120v	Univeral Li-ion Battery Pack with AC Adaptor/ Battery Pack US
710902	UBP-Li-ION-AC-EUR	Univeral Li-ion Battery Pack with AC Adaptor/ Battery Pack EU
710903	UBP-Li-ION-AC-UK	Univeral Li-ion Battery Pack with AC Adaptor/ Battery Pack UK
114883	M41/50/61/71/611-AC-BC-NA	AC Adaptor - USA 120V
710612	M41/50/61/71/611-AC-BC-EU	AC Adaptor - Europe 220V
710613	M41/50/61/71/611-AC-BC-UK	AC Adaptor - UK 240V
142260	BMP-UBP 12V	Rechargeable Lithium Ion battery for the BMP51 printer
143115	M50-BATT-TRAY	BMP50 Series Spare Battery Tray for 8 AA batteries
143109	M50-HC	BMP50 Series Hard Carry Case
121423	M50-SC	BMP50 Series Soft Carry Case
143108	M50-MAGNET	BMP50 Series Magnet Accessory
142265	NET-BT	Bluetooth Network Card
142267	NET-LAN	LAN Network Card
142266	NET-WIFI	WiFi Network Card



Magnet

2 year warranty on all Brady portable printers

Brady offers a 2 year warranty on every Brady Mobile Printer sold.

This manufacturer's warranty is completely free and highlights Brady's commitment to quality and on-the-job reliability.

Flash this QR Code to access to all the details about the Brady warranty.



What if you want more extensive support ?

Brady offers Assist Base, Assist Field and Assist Custom service contracts which include priority assistance for 1, 3 or 5 years to guarantee continued support and the ultimate printer reliability, even in demanding working environments. These agreements also include many great extras versus our free, standard 2 year warranty, such as: spare parts, a solution within 2 business days, free annual preventative maintenance, repair transportation costs, priority access to the technical service team or even a specialist at your premises.

Get all of these extra assurances at the cost of just 1 flat fee repair!



Our training and setup service

- **Brady Setup Base** : Stress free installation of your Brady printer and software by screensharing. We help you produce your first labels.
- **Brady Setup Field** : Stress free installation of your Brady printer and software by a Brady specialist at your premises. We help you produce your first labels.
- **Brady Training Half/Whole day** : Hands-on training by a Brady specialist at your premises.

Please contact us for additional information!



Register your Product

After registering your product you will have access to:

- Technical support
- Notification of updates
- Special offers and product announcements

www.bradyeurope.com/registration



Reliable identification and safety solutions

When temperature, chemicals, pressure or friction make durable identification difficult, and when identification is critical for traceability, production efficiency or workplace safety, Brady responds with expertise, material science knowledge and hassle free label printing solutions to answer your identification challenges.



Laboratory identification
EUR-M-513-EN



Product & wire identification
EUR-0-501-EN



Safety and facility identification
EUR-M-801-EN

Enter the EUR-number of the catalogues above in the website's search engine to get the most recent updates.

Discover more reliable identification - and safety solutions in the Brady catalogues on www.bradyeurope.com/catalogues!

Africa

Randburg, South Africa
Tel.: +27 11 704 3295
Email: africa@bradycorp.com

Benelux

Zelev, Belgium
Tel.: +32 (0) 52 45 78 11
Email: benelux@bradycorp.com

Central & Eastern Europe

Bratislava, Slovakia
Tel.: +421 2 3300 4800
Email: central_europe@bradycorp.com

Denmark

Odense
Tel.: +45 66 14 44 00
Email: denmark@bradycorp.com

France

Roncq
Tel.: +33 (0) 3 20 76 94 48
Email: france@bradycorp.com

Germany, Austria & Switzerland

Egelsbach, Germany
Tel.: +49 (0) 6103 7598 660
Email: germany@bradycorp.com

Hungary

Budaörs
Tel.: +36 23 500 275
Email: central_europe@bradycorp.com

Italy

Gorgonzola
Tel.: +39 02 26 00 00 22
Email: italy@bradycorp.com

Middle East FZE

Dubai, UAE
Tel.: +971 4881 2524
Email: me@bradycorp.com

Norway

Kjeller
Tel.: +47 70 13 40 00
Email: norway@bradycorp.com

Romania

Bucharest
Tel.: +40 21 202 3032
Email: central_europe@bradycorp.com

Russia

Moscow
Tel.: +7 495 269 47 87
Email: central_europe@bradycorp.com

Spain & Portugal

Madrid, Spain
Tel.: +34 900 902 993
Email: spain@bradycorp.com,
portugal@bradycorp.com

Sweden, Finland, Baltic states

Kista, Sweden
Tel.: +46 (0) 8 590 057 30
Email: sweden@bradyeurope.com

Turkey

Istanbul
Tel.: +90 212 264 02 20 / 264 02 21
Email: turkey@bradycorp.com

UK & Ireland

Banbury, UK
Tel.: +44 (0) 1295 228 288
Email: uk@bradycorp.com

Our mission is to identify and protect people, products and places



To help minimise our impact on the environment, Brady limits its number of reprints.

Updated versions are always available for download on www.bradyeurope.com.

Search for: EUR-M-409-EN

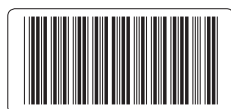

Y1863893

Your distributor

31/07/2020

