

Operating instructions
Commercial dishwasher for laboratory
glassware and utensils
PG 8504



To avoid the risk of accidents or damage to the machine, it is **essential** to read these instructions before it is installed and used for the first time.

en - GB, AE, AU, IE, NZ

M.-Nr. 10 089 650

Contents

Notes about these instructions	5
Intended use	6
User profiles	8
Guide to the machine	9
Overview	9
Control panel	10
LEDs in the buttons	11
Warning and Safety instructions	12
Symbols on the machine	18
Using the machine	19
Display illustrations	19
Switching on	20
Switching off	20
Automatic switch-off (Auto-Off function)	20
Display interface	21
Menu operation	21
Symbols in the display	22
Menu operation	23
Options	23
Commissioning	24
Installation and connection	24
Procedure	24
Opening and closing the door	28
Opening the door	28
Closing the door	28
Water softener	29
Water hardness	29
Setting the water hardness level	30
Filling the salt reservoir	32
Add salt reminder	34
Areas of application	35
Mobile units, baskets, modules and inserts	35
Adjusting the upper basket	37
Preparing the load	39
Wash load	42
...wide necked	42
...narrow necked	42
Chemical processes and technology	43
Adding and dispensing chemical agents	47
Using chemical agents	47
Dispensing systems	47
Labelling the siphons	47
DOS modules	48
Connecting a DOS module	48
Dispensing liquids	48

Dispensing neutralising agent or rinsing agent	49
Neutralising agent	49
Rinsing agent	49
Filling the reservoir	50
Cleaning agent.....	52
Refilling liquid cleaning agent.....	52
Refill indicator.....	53
Dispensing liquid cleaning agent	53
Dispensing powder cleaning agent.....	54
Operation	56
Selecting a programme	56
Starting a programme.....	56
Starting a programme using delay start.....	56
Programme sequence indicator	58
At the end of the programme	58
Cancelling a programme	59
Programme cancelled due to a fault	59
Cancelling a programme manually.....	59
Settings ▾	60
Delay start.....	61
DOS venting	62
Language ▾	63
Date	64
Time of day.....	66
Volume.....	69
Further settings	70
Code	72
Enter code	72
Release.....	73
Log book.....	75
Temperature unit.....	76
Moving a programme: allocating programme selection buttons.....	77
Additional functions.....	78
Reset	79
Increased water level.....	80
Interim rinse.....	80
Dispensing systems	81
Temperature / Time	85
Release programme	87
Water hardness.....	88
Display: Temperature.....	88
Display brightness and contrast.....	89
Switch off after (Auto-Off function).....	90
Factory default.....	91
Software version.....	91
Maintenance	92
Periodic checks	92
Routine checks.....	93
Cleaning the filters in the wash cabinet.....	93

Contents

Cleaning the spray arms.....	95
Cleaning the machine.....	97
Cleaning the control panel	97
Cleaning the door and the door seal.....	97
Cleaning the wash cabinet.....	97
Cleaning the door front	97
Preventing re-soiling.....	97
Checking mobile units, baskets, modules and inserts.....	98
Problem solving guide	99
Technical faults and messages.....	99
Dispensing / dispensing systems.....	100
Insufficient salt / Water softener.....	102
Cancel with fault code.....	103
Process-related faults and messages	105
Unsatisfactory cleaning and corrosion.....	106
Water inlet and drainage.....	108
Noises.....	109
Remedial maintenance	110
Cleaning the drain pump and non-return valve.....	110
Clean the water intake filters	111
After sales service	112
Contacting Miele Service.....	112
Software version.....	113
Installation	114
Installation and levelling	114
Building under a continuous worktop.....	115
Removing the lid	115
Electromagnetic compatibility	116
Electrical connection	117
Equipotential bonding connection.....	117
Plumbing	118
Connection to the water supply	118
Connecting the drain hose	121
Programme chart	122
Programme selection and suitable accessories.....	124
Technical data	125
Caring for the environment	126
Disposal of the packing material	126
Disposing of your old machine.....	126

Important warnings

 Information which is important for safety is highlighted in a thick framed box with a warning symbol. This alerts you to the potential danger of injury to people or damage to property. Read these warning notes carefully and observe the procedural instructions and codes of practice they describe.

Notes

Information of particular importance that must be observed is highlighted in a thick framed box.

Additional information and comments

Additional information and comments are contained in a simple frame.

Operating steps

Operating steps are indicated by a black square bullet point.

Example:

- Select an option using the arrow buttons and save your choice with *OK*.

Display

Certain functions are shown in display messages using the same font as that used for the function itself in the display.

Example:

Settings  menu.

Intended use

This Miele commercial dishwasher can be used to reprocess laboratory glassware and laboratory utensils with water based media. The process includes cleaning and rinsing. Due to the wide variety of laboratory glassware and laboratory utensils on the market, it may be necessary in some cases to establish whether it is suitable for reprocessing in a dishwasher. This will depend on its use and the type of soiling present. Please also observe information provided by the manufacturer of the laboratory glassware and laboratory utensils.

Laboratory glassware and laboratory utensils suitable for reprocessing include a range of items from evaporating dishes to centrifuge tubes, for example:

- Vessels such as test tubes, beakers, flasks, etc.
- Measuring vessels such as measuring cylinders, volumetric flasks etc.
- Dishes such as petri dishes, watch glasses, etc.
- Plates such as slides, sequencing plates, etc.
- Small items such as lids, spatulas, magnetic stirring rods, stoppers, etc.
- Other items such as funnels, pipe/hose pieces, etc.

Pipettes are not included in this list. They are not suitable for reprocessing in this commercial dishwasher.

Examples of application areas:

- Laboratories in schools, colleges and universities,
- Different areas of inorganic, organic, analytical and physical chemistry,
- Biology (excluding agriculture soiling).

Laboratory glassware and laboratory utensils for reprocessing are referred to as the wash load if they are not more closely defined.

Processing conditions must be suitable for the wash load and for the type of soiling.

Chemical agents must be suitable for the type of soiling and for methods of analysis being used.

The use of a suitable carrier (mobile unit, basket, module, insert, etc.) is important to ensure the adequate cleaning of the load. Examples are given in the section "Areas of application".

This machine is programmed to carry out the final rinse with mains water or with processed water of a quality to suit the application (e.g. purified water, fully demineralised water or demineralised water). It is particularly important to ensure the appropriate water quality for the rinse and final rinse of items for analytical purposes.

The machine can be qualified for process validation.

The machine fulfills the requirements of Directive 2006/42/EC on machinery

Intended use

User profiles

Daily operators

Daily operators must be instructed in operating and loading the machine and trained regularly to guarantee safe daily use. They require knowledge of machine reprocessing of laboratory glassware and utensils.

Tasks for daily routine operation are located in the Settings  menu. This menu is freely accessible to all users.

Administration

More advanced tasks, e.g. interrupting or cancelling a programme, require more detailed knowledge about the machine reprocessing of laboratory glassware and utensils.

Alterations or adaptations of the machine, e.g. accessories used or on-site conditions require additional specific knowledge of the machine.

Validation processes assume specialised knowledge of the machine reprocessing of laboratory glassware and utensils, of the processes involved and of applicable standards and legislation.

Administrative processes and settings are allocated to the Further settings. This is protected from unauthorised access by a code.

Overview

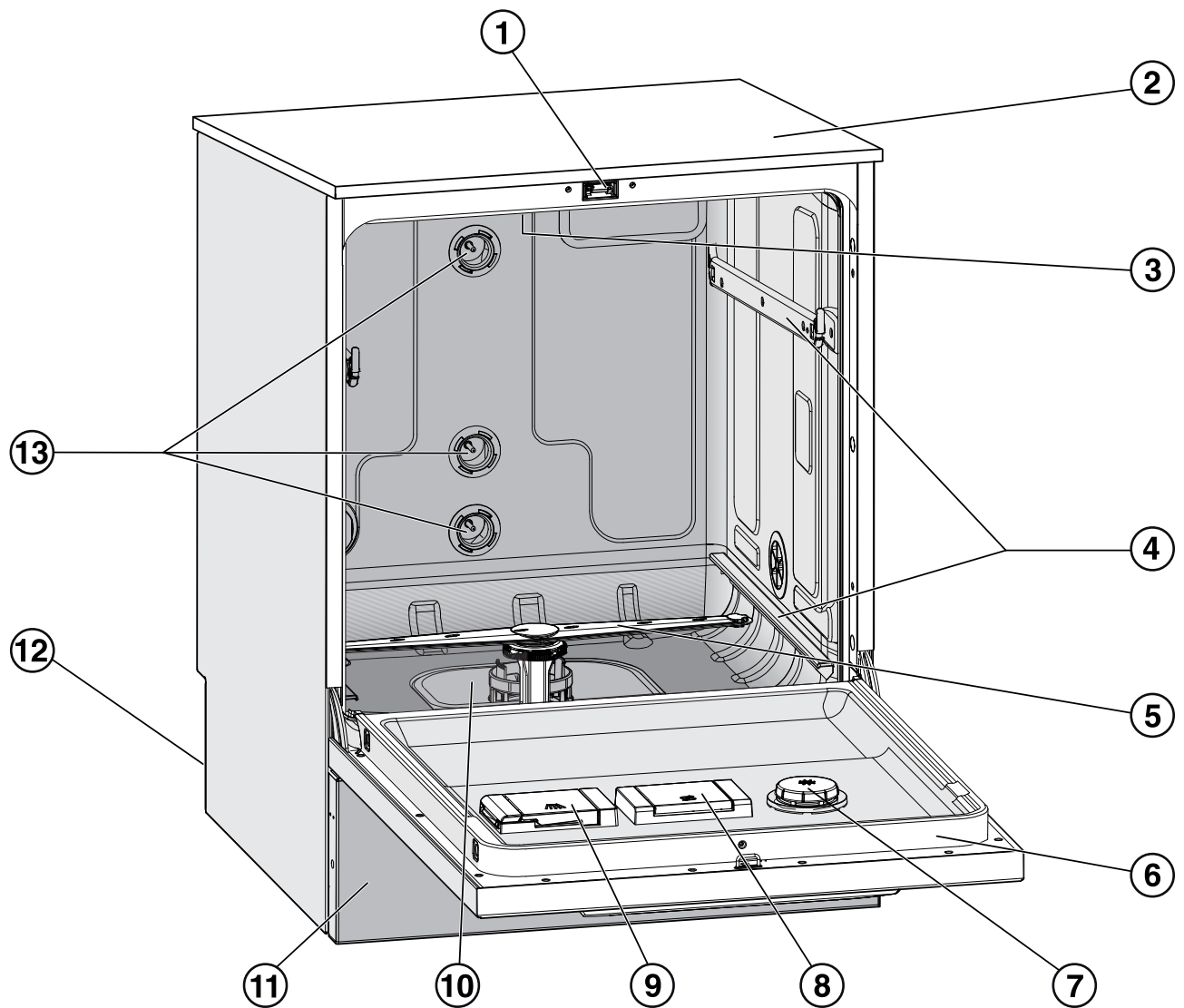

- ① Door lock
- ② Test point for performance checks (Top, front right; only visible with lid removed)
- ③ Upper machine spray arm
- ④ Rails for baskets and mobile units
- ⑤ Lower machine spray arm
- ⑥ Data plate
- ⑦ Reservoir for neutralising agent or rinsing agent
- ⑧ Salt reservoir
- ⑨ Dispenser for powder cleaning agent
- ⑩ Filter combination
- ⑪ Plinth
- ⑫ On the back:
 - Second data plate
 - Electrical and plumbing connections
 - Siphon(s) for external supply containers
 - Connections for external dispensing modules (DOS modules)
- ⑬ Plumbing connections for mobile units and baskets

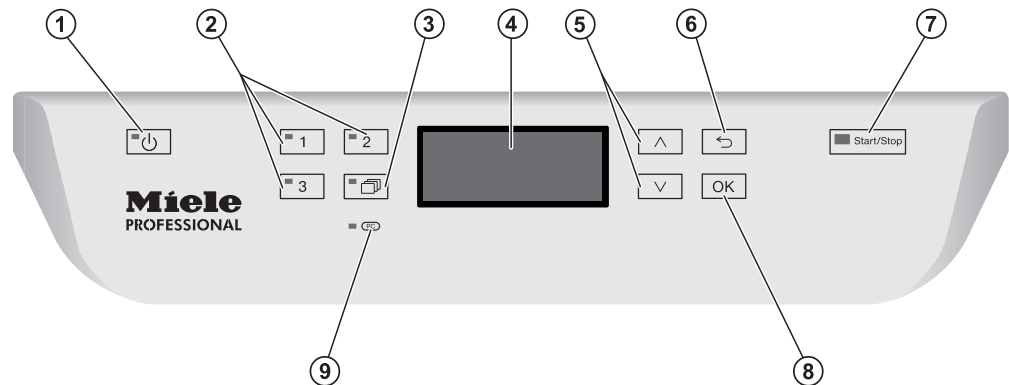

Control panel



- ① **On/Off button**
For switching the machine on and off.
- ② **1, 2 and 3 buttons**
Programme selection buttons.
Can be configured.
- ③ **Programme list button**
For accessing the list of all programmes.
- ④ **Display**
User interface and programme sequence display
- ⑤ **^ and v arrow buttons**
For navigating within the display
- ⑥ **↶ Cancel button**
For cancelling a process
(not for cancelling programmes)
- ⑦ **Start/Stop button**
For starting or cancelling a programme
- ⑧ **OK button**
For selecting or confirming entries in the user interface.
- ⑨ **PC / Optical interface**
This is used by Miele service technicians to run diagnostic checks
and can also be used to update programming data in the future.

LEDs in the buttons

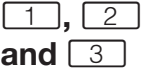
The buttons on the control panel have LEDs (Light Emitting Diodes) that indicate the status of the machine.

Button	LED	Status
 button	ON	The machine is switched on.
	OFF	The machine is switched off.
Programme selection buttons 	ON	The respective programme has been selected. At the end of the programme the LED will remain lit until a different programme is selected.
	OFF	The programme is not selected or the programme settings are being selected.
 button	ON	A programme has been selected from the programme list with this button. At the end of the programme the LED will remain lit until a different programme is selected.
	OFF	No programme has been selected from the list with this button or the programme settings are being selected.
<i>Start/Stop button</i>	ON	Programme running
	FLASHES GREEN	A programme has been selected but not yet started.
	FLASHES RED	A fault has occurred (see "Problem solving guide").
	OFF	A programme has finished.

Warning and Safety instructions

This machine complies with all statutory safety requirements. Inappropriate use can, however, lead to personal injury and material damage.

Read these instructions carefully before using it for the first time to avoid the risk of accidents and damage to the machine.

Keep these instructions in a safe place where they are accessible to users at all times.

Correct application

► This machine is designed for use with the applications described in these operating instructions only. Alterations or conversions to the machine, or using it for purposes other than those for which it was designed, are not permitted and could be dangerous.

This machine must only be used for cleaning laboratory glassware and utensils if the manufacturer has stated that they are suitable for machine reprocessing. Manufacturer's cleaning and maintenance instructions must also be observed.

Miele cannot be held liable for damage caused by improper or incorrect use or operation of the machine.

► This machine is intended for indoor use only.

Risk of injury

Please pay attention to the following notes to avoid injury

► This machine must be commissioned, serviced and repaired by a Miele authorised and trained service technician only. To ensure compliance with Good Laboratory Practice guidelines, Miele repair and maintenance contracts are recommended. Unauthorised repairs can pose considerable risks to the user.

► Do not install the machine in an area where there is any risk of explosion or of freezing conditions.

► In order to reduce the risk of water damage, the area around the machine should be limited to furniture and fittings that are designed for use in commercial environments.

► If the machine is built under, it must only be installed under a continuous worktop run which is firmly secured to adjacent units to improve stability.

► The electrical safety of this machine can only be guaranteed when correctly earthed. It is essential that this standard safety requirement is met. If in any doubt, please have the on-site wiring system tested by a qualified electrician. Miele cannot be held liable for the consequences of an inadequate earthing system (e.g. electric shock).

► A damaged or leaking machine could be dangerous and compromise your safety. Disconnect the machine from the mains immediately and call the Miele Service Department.

Warning and Safety instructions

- ▶ Personnel operating the machine should be trained regularly. Untrained personnel must not be allowed access to the machine or its controls
- ▶ Only use chemical agents which have been approved by their manufacturer for use in the application you are using. The chemical agent manufacturer is responsible for any negative influences on the material the load is made from and for any damage they may cause to the machine.
- ▶ Take care when handling chemical agents. These may contain irritant, corrosive or toxic ingredients. Please observe the chemical agent manufacturer's safety instructions and safety data sheets. Wear protective gloves and goggles.
- ▶ The machine is designed for operation with water and recommended additive chemical agents only. Organic solvents and flammable liquid agents must not be used in it. This could cause an explosion, damage rubber or plastic components in the machine and cause liquids to leak out of it.
- ▶ The water in the cabinet must not be used as drinking water.
- ▶ Take care not to inhale powder agents. Chemical agents can cause chemical burns in the mouth and throat or lead to asphyxiation.
- ▶ Do not lift the machine by protruding parts such as the control panel or the opened service flap as these could be damaged or torn off.
- ▶ Do not sit or lean on the opened door. This could cause the machine to tip up and be damaged or cause an injury.
- ▶ Be careful when sorting items with sharp pointed ends and positioning them in the machine that you do not hurt yourself or create a danger for others.
- ▶ Broken glass can result in serious injury when loading or unloading. Broken glass items must not be processed in the machine.
- ▶ The machine can get hot when in use. Be careful not to scald or burn yourself or come into contact with irritant substances when opening the door.
- ▶ Should personnel accidentally come into contact with toxic vapours or chemical agents, follow the emergency instructions given in the manufacturer's safety data sheets.
- ▶ Mobile units, baskets, modules, inserts and the load must be allowed to cool down before they are unloaded. Any water remaining in containers could still be very hot. Empty them into the wash cabinet before taking them out.

Warning and Safety instructions

- ▶ Never clean the machine or near vicinity with a water hose or a pressure washer.
- ▶ The machine must be disconnected from the mains electricity supply before any maintenance or repair work is carried out.

Quality assurance

The following points should be observed to assist in maintaining quality standards when processing laboratory glassware and utensils to avoid damage to the loads being cleaned.

- ▶ If it is necessary to interrupt a programme in exceptional circumstances, this may only be done by authorised personnel.
- ▶ The standard of cleaning and disinfection must be routinely confirmed by the user. The process should be validated on a regular basis, and checked against documented control results.
- ▶ Make sure items being washed are suitable for machine reprocessing and are in good condition. Plastic items must be thermally stable. Nickel plated items and aluminium items can be machine processed using special procedures only. Items containing iron, and soiling containing residual rust must not be placed in the cabinet.
- ▶ Chemical agents can, in certain circumstances, cause damage to the machine. Always follow the recommendations of the chemical agent manufacturer.
In case of damage or doubt about compatibility, please contact Miele.
- ▶ Abrasive substances must not be placed in the machine as they could cause damage to the mechanical components of the water supply. Any residues of abrasive substances on items to be washed must be removed without trace before reprocessing in the machine.
- ▶ Pre-treatments with cleaning or disinfecting agents can create foam, as can certain types of soiling and chemical agents. Foam can have an adverse effect on the cleaning result.
- ▶ Processes must be set up such that foam cannot escape from the wash cabinet. It would hinder the correct functioning of the machine.
- ▶ The process used must be monitored on a regular basis by the supervisor to check foaming levels.
- ▶ To avoid the risk of damage to the machine and any accessories used with it caused by chemical agents, soiling and any reaction between the two please read the notes in "Chemical Processes and Technology".

Warning and Safety instructions

- ▶ Where a chemical agent is recommended on technical application grounds (e.g. a cleaning agent), this does not imply that the manufacturer of the machine accepts liability for the effect of the chemical on the items being cleaned.
Please be aware that changes in formulation, storage conditions etc. which may not be publicised by the chemical manufacturer, can have a negative effect on the cleaning result.
- ▶ When using a chemical agent it is essential that the manufacturer's instructions are followed. The chemical agent must only be used for the application it is designed for and in the situation specified, to avoid material damage and such dangers as a severe explosive chemical reaction (e.g. an explosive oxyhydrogen gas reaction).
- ▶ Always follow the relevant manufacturer's instructions on storage and disposal of chemical agents.
- ▶ In critical applications where very stringent requirements have to be met, it is strongly recommended that all the relevant factors for the process, such as chemical agents, water quality etc. are discussed with the Miele Application Technology specialists.
- ▶ If the cleaning result is subject to particularly stringent requirements, a regular quality control test should be carried out by the user to ensure that required standards of cleanliness are being achieved
- ▶ Mobile units, baskets, modules and inserts should only be used for the purpose they are designed for.
Hollow items must be thoroughly cleaned, internally and externally.
- ▶ Secure small and light items with cover nets or place in a mesh tray for small items, so that they do not block the spray arms.
- ▶ Empty any containers or utensils before loading them.
- ▶ The amount of residual solvents and acids on items going into the cabinet should be minimal.
There should be no more than a trace of any solvents with a flash point of below 21 °C.
- ▶ Chloride solutions, in particular hydrochloric acid, must not be placed in the cabinet.
- ▶ Ensure that solutions or steam containing chlorides or hydrochloric acid do not come into contact with the stainless steel outer casing of the machine in order to avoid any damage through corrosion.
- ▶ After any plumbing work the water pipework to the machine will need to be vented. If this is not done, components can be damaged.
- ▶ The gaps between a built-in machine and adjacent cabinetry must not be filled with silicone sealant as this could compromise the ventilation to the circulation pump.

Warning and Safety instructions

- ▶ Follow the installation instructions in the operating and installation instructions.

Safety with children

- ▶ Children must be supervised in the vicinity of the machine. Do not allow children to play with the machine. They could get locked inside it.
- ▶ Children must not use the machine.
- ▶ Keep children away from chemical agents. These can cause burning in the mouth, nose and throat if swallowed, or inhibit breathing. Keep children away from the machine when the door is open. There could still be residual chemical agent in the cabinet. Observe the safety data sheets for the chemical agent and seek medical advice immediately if a child has swallowed chemical agent or got it in the eyes.

Using accessories

- ▶ Only Miele accessories should be connected to this machine. They must be suitable for the application they are required for. Consult Miele for details on the type of accessories that can be used.
- ▶ Only use Miele mobile units, baskets, modules and inserts with this machine. Using mobile units, baskets, modules and inserts made by other manufacturers, or making modifications to Miele accessories can cause unsatisfactory cleaning results, for which Miele cannot be held liable. Any resultant damage would not be covered by the guarantee.

Warning and Safety instructions

Symbols on the machine

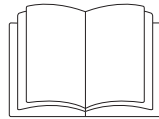

Warning:
Observe the operating instructions



Warning:
Danger of electric shock

Disposing of your old machine

► Please note that the machine may have contamination from blood, bodily fluids, pathogenic germs, facultative pathogenic germs, genetically modified material, etc. in it and must be decontaminated before disposal.

For environmental and safety reasons ensure the machine is completely drained of any residual water, chemical residues and cleaning agent. Observe safety regulations and wear safety goggles and gloves.

Make the door lock inoperable, so that children cannot accidentally shut themselves in. Then make appropriate arrangements for its safe disposal.

Miele cannot be held liable for damage caused by non-compliance with these Warning and Safety Instructions.

Control panel

The machine is operated exclusively by the buttons located on the stainless steel surfaces either side of the display. The display is not a touch screen.

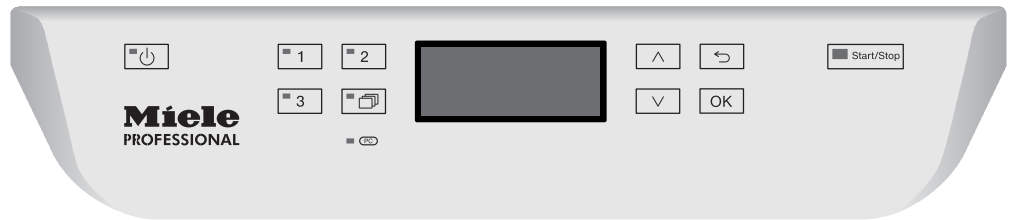

A light touch on the relevant button is sufficient to operate the functions. The buttons can also be pressed and held for approx. 20 seconds.

Display illustrations

All display illustrations shown in these operating instructions are examples which can be different from the actual display screens shown.

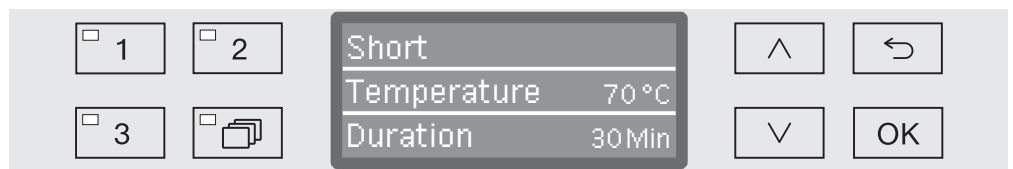

The control buttons, with the exceptions of the  and the *Start/Stop* buttons, are shown next to the display.

Using the machine

Switching on

The machine must be connected to the electrical supply.

- Press the  button until the LED lights up.

After that, the display will show the following:



As soon as the machine is ready for operation, the display changes to show the last selected programme, e.g.

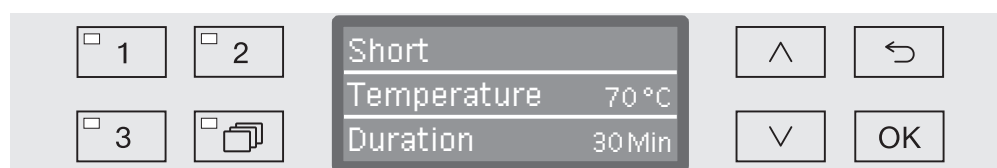

If the machine is being used for the first time, or if the factory settings have been reinstated, some basic parameters, e.g. language, date, time of day, etc. must first be set. To enable this, the display automatically changes to the relevant screen.

Switching off

- Press the  button.

The time of day can optionally be displayed when the machine is switched off (see "Settings  / Time of day").

Automatic switch-off (Auto-Off function)

To save energy the machine has an automatic switch-off function (Auto-Off function). If the machine is not used for a pre-determined duration, it switches itself off automatically. Automatic switch-off can be optionally activated and deactivated (see "Further settings / Switch off after").

- Switch the machine on again using the  button.

Display interface



The machine is controlled by menus. The menus are displayed in a 3-line display on the control panel.

The name of the menu (top line) and up to two options are shown. The currently selected option is highlighted, e.g.



Menu operation

To access the system settings menu you must first switch the machine off with the  button.

Then press and hold the  button whilst switching the machine back on with the  button.

Then release both buttons.

 and 

Arrow buttons

The arrow buttons are used to navigate up and down by row within a menu. Press and hold the button to automatically scroll through the list to the end of the menu. Press the button again to continue navigating.

Parameter values can also be altered in defined increments using the arrow buttons. Instructions for this can be found in the relevant sections.

OK

OK button

The *OK* button is used for confirming (acknowledging) a selection or for saving input. The display then moves to the next menu or, when entering parameter values, to the next input position. Instructions for this can be found in the relevant sections.



Cancel button

Before the *OK* button has been pressed, a process can be cancelled at any time by pressing the  button. The menu is then ended early and the display changes to the next menu level up. Any setting changes made will not be saved.

Using the machine

Symbols in the display



Navigation arrows

If a menu consists of more than two options, two navigation arrows are shown at the side of the menu options.



Use the ^ and v arrow buttons on the control panel to navigate through the menu.



Dotted line

If a menu contains more than two options, the end of the option list is marked by a dotted line. The last entry appears above the line, the first entry below it.



Tick

If there are several options available, the current setting is marked with a tick ✓.

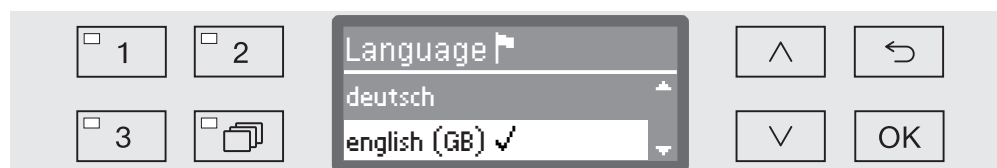

System messages

The **i** symbol denotes system messages. These give information, such as if the level is too low in the supply containers or a reminder for the next service.

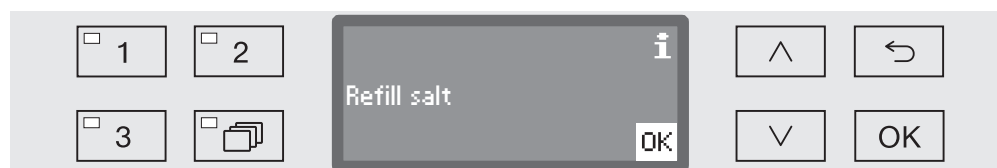

System messages are displayed at the start and end of a programme and have to be confirmed (acknowledged) individually with **OK** or all together at the end of the programme by opening the door. If the **i** symbol appears in the display during a programme, the system messages can be accessed by pressing and holding the **OK** button.



Fault messages

In the event of a fault a warning triangle is shown in place of the **i** symbol. See "Problem solving guide" and "After sales service" for more information.



Menu operation

All menu descriptions in these operating instructions are structured as follows:



Input procedure

The input procedure describes the complete sequence required to reach a particular menu level. The menu options shown must be selected individually using the arrow buttons and then confirmed with *OK*.

Example:

- To access the system menu you have to switch the machine off with the  button and, whilst holding the  button pressed in, switch the machine back on again with the .

- ▶ Settings 
 - ▶ Time of day
 - ▶ Clock display

If a menu level is already displayed, the path does not need to be input completely. If for example the Settings  menu is already displayed, you do not need to switch the machine off and back on again. In this case simply follow the sequence from Settings  onwards.

Display view

When selecting a menu, the last menu used is generally opened.

Example:



Options

All available menu options are listed together with a short description.

Example:

- 12 h
Time of day display in 12 hour format (am/pm).
- 24 h
Time of day in 24 hour format.

Method

Then further instructions are given.

Example:

- Select an option using the arrow buttons.
- Press *OK* to save the setting.

Commissioning

Installation and connection

Before commissioning the machine must be securely installed, and the water inlet and drain hoses and the mains cable correctly connected. See "Installation", "Plumbing connections" and "Electrical connection" and the installation diagram supplied.

Procedure

During commissioning a set procedure is followed which must not be interrupted. The display will automatically guide you through the process.

All settings, except for selecting plumbing connections, can be retrospectively altered via the Settings  and Further settings menus.

The settings made during the commissioning process are only adopted after a complete programme has been run. If the programme is interrupted or if no programme is started and the machine is switched off, the commissioning process must be carried out again.

Switching on

- Press the  button until the LED lights up.

Select language

The commissioning process starts with selecting the language.

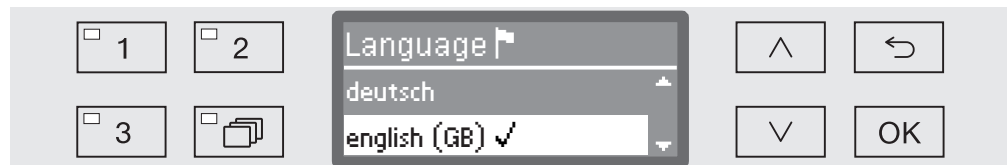

- Use the \wedge and \vee arrow buttons to select the language you want and touch *OK* to save.

Select temperature unit

The menu for selecting the temperature unit will then appear.

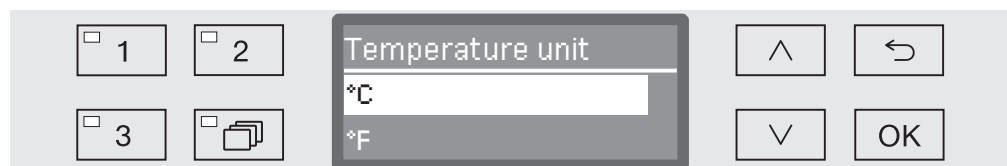

- Use the \wedge and \vee arrow buttons to select the temperature unit you want and touch *OK* to save.

Select the date format

The menu for selecting the date format will then appear.

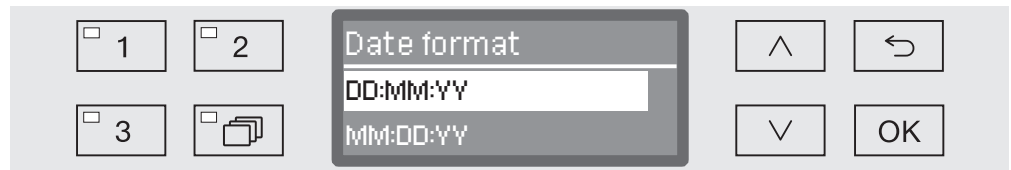

- DD = Day
- MM = Month, and
- YY = Year.

- Use the \wedge and \vee arrow buttons to select the date format you want and touch *OK* to save.

Set the date

The menu for setting the date will then appear.

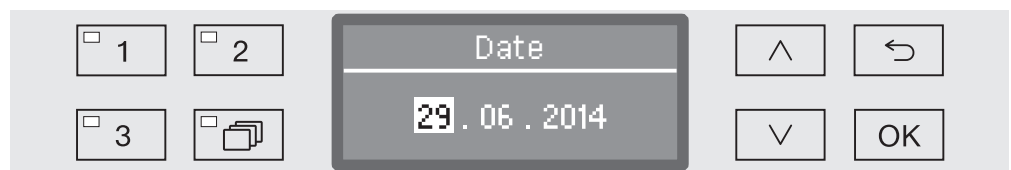

- Use the \wedge and \vee arrow buttons to set the day, month and year and touch *OK* to save each one.

Select Clock display

The menu for selecting the clock format will then appear.



- Use the \wedge and \vee arrow buttons to select the format you want and touch *OK* to save.

Set the time of day

The menu for setting the display for the time of day will then appear.

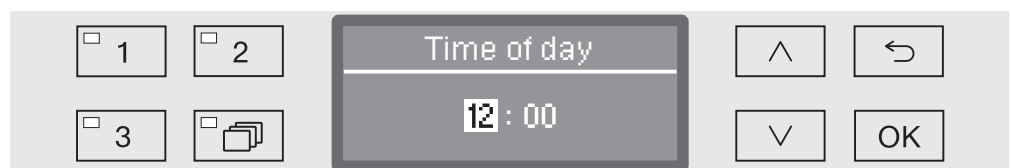

- Use the \wedge and \vee arrow buttons to select the hours and minutes and touch *OK* to save each one.

Commissioning

Setting the water hardness level

The menu for setting the water hardness will then appear.

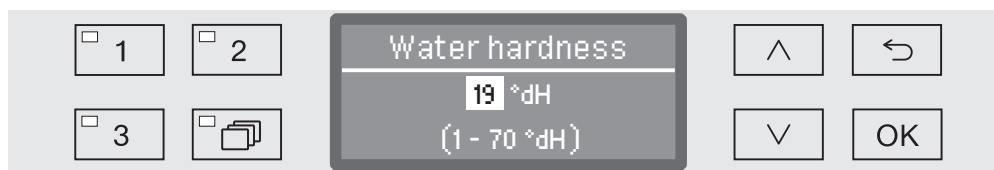

The bottom line of the display shows the possible input range. Water hardness input values can be found in the chart in "Water softener/ Settings chart".

Your local water authority can give you information about the exact water hardness in your area.

Where the water hardness fluctuates, e.g. between 1.4 - 3.1 mmol/l (8 - 17 °dH), always programme the machine to the higher value, 3.1 mmol/l (17 °dH) in this example.

- Set the water hardness using the arrow buttons \wedge (higher) and \vee (lower) and touch *OK* to save.
- Write down the water hardness in "Water softener / Water hardness".

Select plumbing connections

The menu for setting plumbing connections will then appear.

Unused plumbing connections, e.g. if there is only one connection, can be deactivated here.

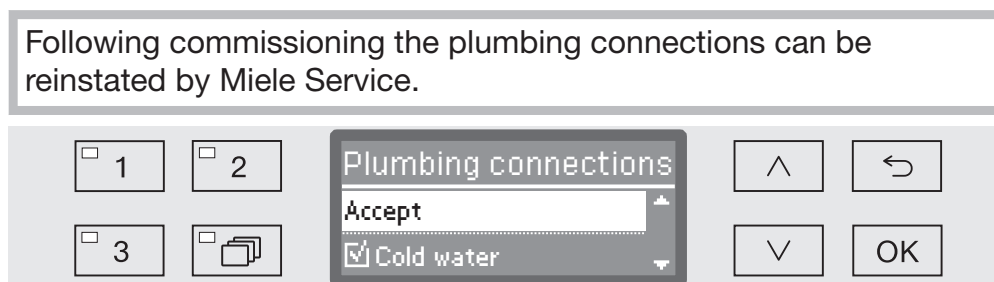

The plumbing connection is set via multiple choice. A box is shown in the display next to all plumbing connections. If the connection is activated, a tick can be seen in it. Select to activate or deactivate the plumbing connections.

- Use the \wedge and \vee arrow buttons to select the plumbing connection you want. Plumbing connections are activated or deactivated by touching *OK*.
- To save the selection select the *Accept* option at the end of the list and confirm with *OK*.

Commissioning completed

Commissioning is completed when the following message is displayed.

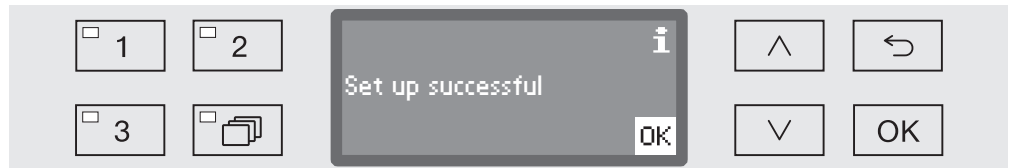

- Confirm the message with *OK*.

The machine is now ready for use.

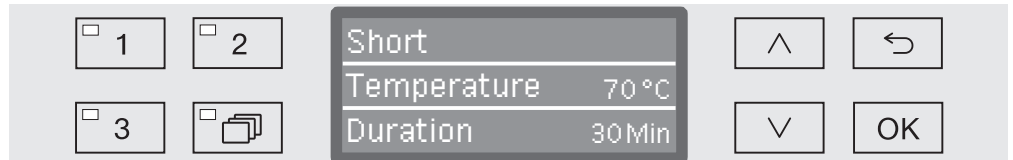

After commissioning every programme starts with reactivation of the water softener.

Opening and closing the door

Opening the door

⚠ If the door is opened during a programme cycle, hot water and cleaning agents can escape.

Risk of scalding, burning and chemical burns.

Do not open the door if a programme is running.

The control panel of the machine is also a door handle.

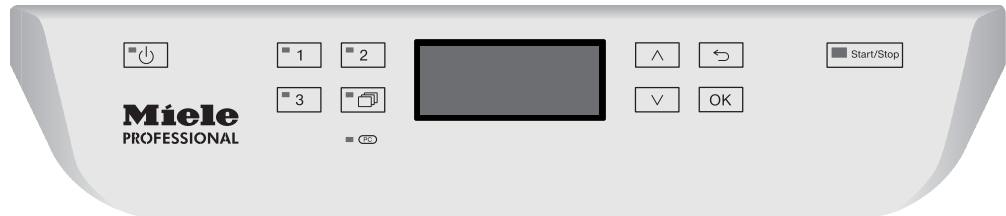

- Grasp the handle underneath the control panel and lower the door to open it.

Closing the door

⚠ Do not put your hand inside the door as it is closing.
Danger of injury.

- Lift the door until it engages with the door lock.

Water hardness

In order to achieve good cleaning results, the machine needs to operate with soft water. Hard water results in the build-up of calcium deposits on the load and in the machine.

Mains water with a hardness of more than 0.7 mmol/l (4 °dH German scale) must be softened. This occurs automatically in the built-in water softener.

The water softener must be set to the exact hardness of the mains water (see "Water softener / Setting the water hardness").

Your local water authority will be able to tell you the exact degree of hardness in the mains water supply. For future servicing it is useful to make a note of your water hardness level. Enter your water hardness level here:



_____ ° dH or mmol/l

The water softener must also be reactivated at regular intervals. To do this special reactivation salt is required (see "Water softener / Filling the salt reservoir"). Reactivation occurs automatically during a programme sequence.

If the hardness level of your water is constantly less than 0.7 mmol/l (= 4 °dH) salt is not required for the water softener. The water hardness level must however still be set.

Setting the water hardness level

Water hardness can be set between 0 and 12.6 mmol/l (0 - 70 °dH).

- Open the Further settings menu by switching the machine off with the  button and then switch it on again with the  button whilst keeping the  button held in.
- Open the menu as follows:
 - ▶ Further settings
 - ▶ Water hardness

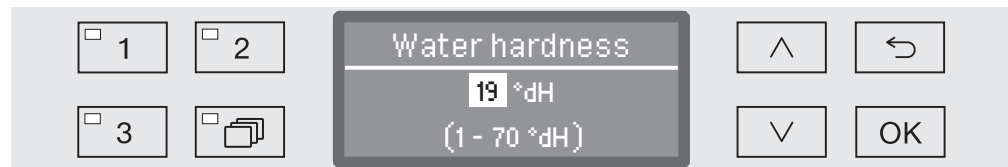

The bottom line of the display shows the possible input range. Water hardness input values can be found in the chart on the next page.

Where the water hardness fluctuates, e.g. between 1.4 - 3.1 mmol/l (8 - 17 °dH), always programme the machine to the higher value, 3.1 mmol/l (17 °dH) in this example.

- Set the water hardness level using the arrow buttons (\wedge = higher and \vee = lower).
- Press "OK" to save the setting.

Settings

°dH	°f	mmol/l	Display
1	2	0.2	1
2	4	0.4	2
3	5	0.5	3
4	7	0.7	4
5	9	0.9	5
6	11	1.1	6
7	13	1.3	7
8	14	1.4	8
9	16	1.6	9
10	18	1.8	10
11	20	2.0	11
12	22	2.2	12
13	23	2.3	13
14	25	2.5	14
15	27	2.7	15
16	29	2.9	16
17	31	3.1	17
18	32	3.2	18
19	34	3.4	19 *)
20	36	3.6	20
21	38	3.8	21
22	40	4.0	22
23	41	4.1	23
24	43	4.3	24
25	45	4.5	25
26	47	4.7	26
27	49	4.9	27
28	50	5.0	28
29	52	5.2	29
30	54	5.4	30
31	56	5.6	31
32	58	5.8	32
33	59	5.9	33
34	61	6.1	34
35	63	6.3	35

°dH	°f	mmol/l	Display
36	65	6.5	36
37	67	6.7	37
38	68	6.8	38
39	70	7.0	39
40	72	7.2	40
41	74	7.4	41
42	76	7.6	42
43	77	7.7	43
44	79	7.9	44
45	81	8.1	45
46	83	8.3	46
47	85	8.5	47
48	86	8.6	48
49	88	8.8	49
50	90	9.0	50
51	92	9.2	51
52	94	9.4	52
53	95	9.5	53
54	97	9.7	54
55	99	9.9	55
56	101	10.1	56
57	103	10.3	57
58	104	10.4	58
59	106	10.6	59
60	108	10.8	60
61	110	11.0	61
62	112	11.2	62
63	113	11.3	63
64	115	11.5	64
65	117	11.7	65
66	119	11.9	66
67	121	12.1	67
68	122	12.2	68
69	124	12.4	69
70	126	12.6	70

*) Factory default setting

Filling the salt reservoir

Use only special, coarse-grained reactivation salt with a granule size of approx. 1 - 4 mm.

Do not under any circumstances use other types of salt such as table salt, agricultural or gritting salt. These may contain insoluble additives which can impair the functioning of the water softener.

⚠ Inadvertently filling the salt reservoir with cleaning agent will cause serious damage to the water softener.

Before filling the salt container make sure that you have picked up the right packet of reactivation salt.

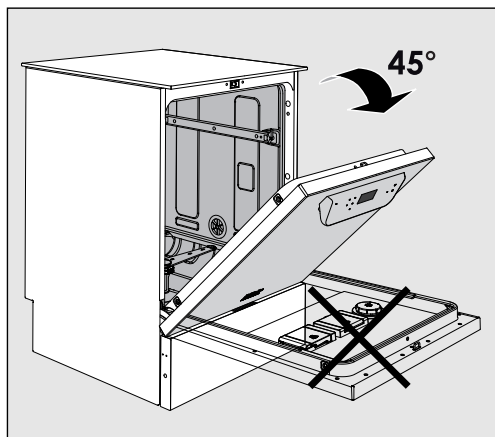

- Open the door to an angle of approx. 45°. This ensures that the salt flows into the reservoir more easily.

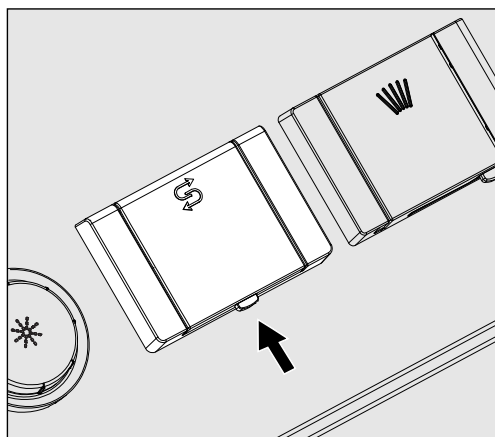

- Press the yellow button on the salt reservoir with the  symbol on it in the direction of the arrow. The flap will spring open.
- Lift up the funnel.

The reservoir takes approx. 1.4 - 2 kg of salt, depending on the type of salt and how much is left in.

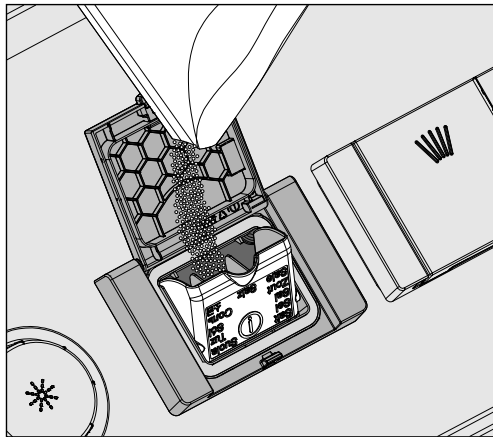

⚠ Do not fill the reservoir with water.
The reservoir could overflow when filled with salt.

- Add salt only until the funnel of the salt reservoir is full, so that it can close properly. Do not add more than 2 kg of salt.

As the salt reservoir is being filled, displaced water (saline solution) may run out.

- Clean any excess salt from the area around the salt reservoir and especially from the seal. **Do not** use running water as this can cause the salt reservoir to overflow.
- Close the funnel.
- Run the Rinsing programme after refilling salt.

This will ensure that any traces of salt and saline solution are dissolved and rinsed away.

Salt and saline solution which has overflowed can cause corrosion damage if they are not rinsed away.

Water softener

Add salt reminder

If the salt level in the reservoir is low, the following reminder will appear:

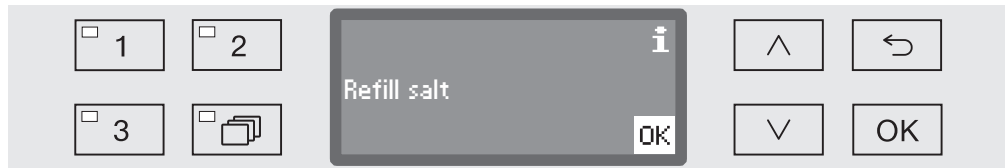

- Confirm the message with the *OK* button and
- fill the reservoir as described.

When the message first appears, there may be sufficient salt for a further programme, depending on the water hardness level set.

If there is no saline solution left in the water softener, a relevant message will appear in the display and the machine will be locked for further use.

The machine can be used again a few seconds after the salt has been refilled.

Mobile units, baskets, modules and inserts

This machine can be equipped with an upper and lower basket or a mobile unit which can be fitted with different inserts and modules or exchanged for special accessories depending on the items to be washed.

Select accessories which are appropriate for the application.

Information on the individual areas of application can be found on the following pages, as well as in the operating instructions for the mobile units, baskets, modules and inserts (if available).

For all areas of application defined in "Intended use" Miele offers suitable accessories such as mobile units, baskets, modules and inserts and special fittings. Contact Miele for more information.

 When using an upper basket with a spray arm at the same time as 2 injector modules in the bottom basket, the amount of water required has to be increased by + 1.5 l for the programme (see "Further settings / Additional functions").
Using up to 4 injector modules in the upper basket and the lower basket at the same time is not permitted.

See "Programme chart" for an overview of which programmes can be used for which accessories.

Areas of application

Water supply

Mobile units and baskets with spray arms or other rinse fittings are equipped with one or more connection points to the water supply. When loading baskets, mobile units, etc into the machine, connect these to the water connection points in the back panel of the wash cabinet. The mobile units and baskets are held in place by the wash cabinet door when closed.

Any free connections in the back panel are closed mechanically.

Older models of mobile units and baskets

Only use older models of mobile units and baskets in this machine in consultation with Miele. In particular mobile units and baskets with water supply pipes for spray arms and injector manifolds must be converted to the new type of water connector.

Conversion must be carried out by Miele Service and is only available for selected models.

 The fitting of connectors for the water supply of mobile units and baskets must be carried out by Miele Service.
Fitting faults on mobile units and baskets can cause damage to the machine.

Following conversion, mobile units and baskets can no longer be used in older models of the machine.

Adjusting the upper basket

Height-adjustable upper baskets can be adjusted between three positions with 2 cm between each position to accommodate items of different heights.

To adjust the height, the brackets with rollers on the side of the upper basket and the water connector at the back of the basket have to be moved. The roller brackets are each secured to the upper basket by two screws. The water connector consists of the following components:

- A stainless steel plate with 2 apertures,
- a plastic connection piece and
- 6 screws.

Only adjust the upper basket horizontally. The baskets are not designed to be positioned on a slant (one side up, one side down). Altering the height will alter loading heights for both the upper and lower baskets.

To adjust the upper basket:

- Remove the upper basket by pulling it out until a resistance is felt and lifting it off the runners.
- Unscrew the roller brackets and the water connector.

To adjust the upper basket to the ...

... Upper position:

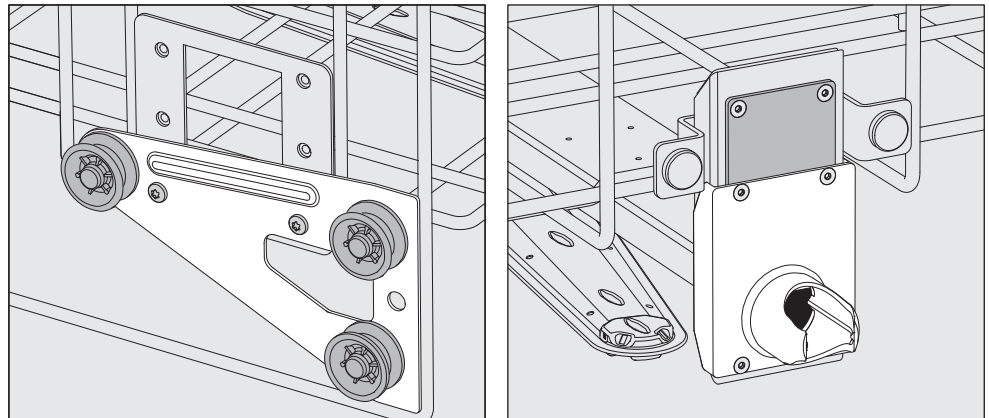

- Move the roller brackets on both sides to the lower position and secure them firmly.
- Position the stainless steel plate over the openings in the water supply pipe so that the upper aperture is covered. Secure the stainless steel plate at the top with 2 screws. Place the water connector in the lower aperture of the stainless steel plate so that the middle aperture is covered. Secure the water connector with 4 screws.

Areas of application

... Middle position:

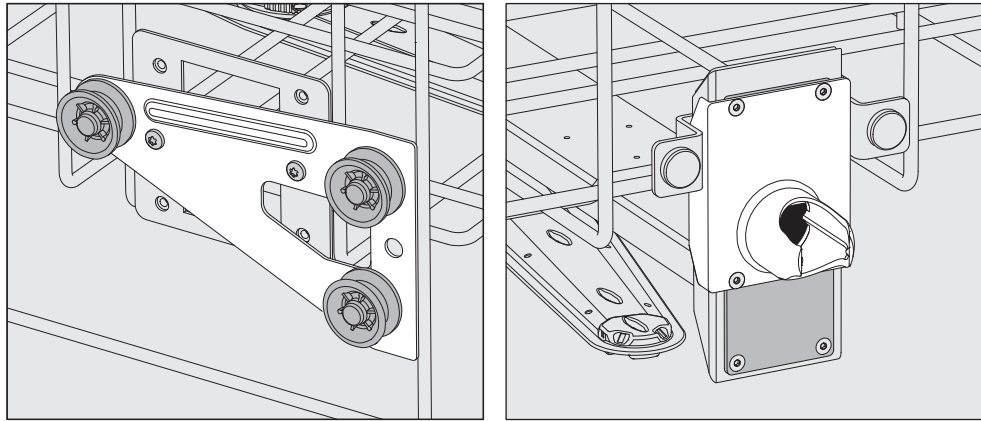

- Move the roller brackets on both sides to the middle position and secure them firmly.
- Position the stainless steel plate over the openings in the water supply pipe so that one of the outer apertures is covered. Secure the stainless steel plate at the top or bottom with 2 screws. Place the water connector in the middle aperture of the stainless steel plate so that the outer aperture is covered. Secure the water connector with 4 screws.

... Lower position:

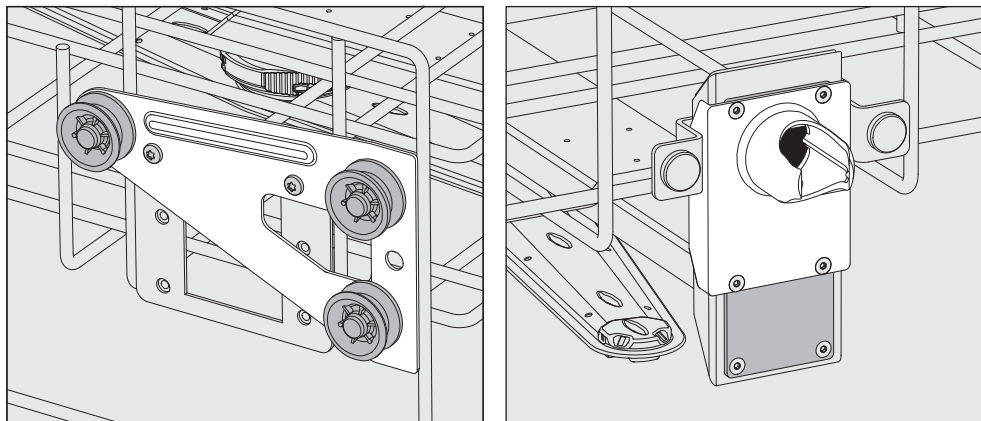

- Move the roller brackets on both sides to the top position and secure them firmly.
- Position the stainless steel plate over the openings in the water supply pipe so that the lower aperture is covered. Secure the stainless steel plate at the bottom with 2 screws. Place the water connector in the upper aperture of the stainless steel plate so that the middle aperture is covered. Secure the water connector with 4 screws.

Then check:

- Replace the upper basket on the rails and push it in carefully to check that the water connector is positioned correctly.

Preparing the load

⚠ Only items which have been declared by their manufacturer as suitable for machine reprocessing may be processed. The manufacturer's specific reprocessing instructions must be observed.

Special injector nozzles, irrigation sleeves or adapters may be required for appropriate internal cleaning, depending on the load. These, together with other accessories, are available from Miele.

- Arrange the load so that water can access all surfaces. This ensures that it gets properly cleaned.
- Do not place items to be cleaned inside other pieces where they may be concealed.
- Hollow items must be thoroughly cleaned, internally and externally.
- Ensure that items with long narrow hollow sections can be flushed through properly before placing them in a fitting or when connecting them to a water connection.
- Hollow vessels should be inverted and placed in the correct mobile units, baskets, modules and inserts to ensure that water can flow in and out of them unrestricted.
- Deep-sided items should be placed at an angle to make sure water runs off them freely.
- Tall, narrow, hollow items should be placed in the centre of the baskets or units if possible to ensure better water coverage.
- Take apart any items which can be dismantled according to the manufacturer's instructions and process the individual parts separately from each other.
- Lightweight items should be secured with a cover net (e.g. an A 6) and small items placed in a mesh tray to prevent them blocking the spray arms.
- The spray arms must not be blocked by items which are too tall or which hang down in their path.
- Broken glass can result in serious injury when loading or unloading. Broken glass items must not be processed in the machine.
- Nickel and chrome plated items and items made of aluminium require special procedures and are not generally suitable for machine reprocessing.
- Plastic items must be thermally stable.

Observe the further information given in the following sections as necessary depending on area of application.

Preparing the load

- Empty all containers before loading into the machine (paying particular attention to relevant regulations).

Areas of application

- Remove non-water soluble residues such as paint, adhesives and polymer compounds using appropriate solvents.
- Rinse wash load items which have been in contact with chloride solutions or hydrochloric acid thoroughly with water before loading in the machine and drain well.

⚠ The amount of residual solvents and acids on items going into the cabinet should be minimal.
Acids, in particular hydrochloric acid and chloride solutions as well as items containing iron that can rust or corrode must not be placed in the machine.
The presence in soiling of any solvents should be no more than a trace (especially those in hazard class A1).

- Shake out any blood residues and remove any clots.
- If necessary rinse the wash load briefly with water to avoid introducing coarse soiling into the machine.
- Remove stoppers, corks, labels, sealing residues, etc.
- Secure small items, such as stoppers and taps in suitable baskets for small items.

It may be necessary in individual cases to check whether extremely stubborn contamination e.g. vacuum grease, paper labels, etc. which could affect the cleaning result, must be removed in advance.

It must be determined whether wash load items which are contaminated with microbiological material, pathogenic germs, facultative pathogenic bacteria, genetically modified material etc. need to be sterilised prior to machine reprocessing.

Carry out a visual check before starting every programme:

- Is everything correctly loaded/connected for cleaning?
- Was the recommended loading template followed?
- Can the lumen / narrow sections of hollow items be accessed by the wash fluid?
- Are the spray arms clean and do they rotate freely?
- Are the filters clean?
Remove any coarse soiling and clean them if necessary.
- Are the removable modules, injector nozzles, irrigation sleeves and other rinsing fittings securely connected?
- Are the baskets and modules or mobile units correctly connected to the water supply and are the water connectors undamaged?
- Are all chemical containers sufficiently filled?

The following must be checked at the end of every programme:

- Carry out a visual check of the load for cleanliness.
- Check that all hollow items are still securely located on their injector nozzles.

 Any hollow items that have become disconnected from their fittings during reprocessing must be reprocessed.

- Check that the lumen of hollow items are free of obstruction.
- Check that injector nozzles and connectors are securely held in position in the baskets or inserts.

Areas of application

Wash load...

...wide necked

Wash load items with wide necks, e.g. beakers, wide necked Erlenmeyer flasks and petri dishes, or cylindrical items, e.g. test tubes, can be cleaned inside and out by rotating spray arms. To do this the wash load is positioned in full, half or quarter inserts and placed in an empty lower basket or an upper basket with a spray arm.

...narrow necked

Baskets with special injector modules are available for wash load items with narrow necks, e.g. narrow necked Erlenmeyer flasks, round bottomed flasks and measuring flasks.

The injector units and modules come with their own operating instructions.

When loading please note:

- Place petri dishes in the appropriate insert with the dirty side facing towards the middle.
- Quarter segment inserts should be positioned at a minimum 3 cm distance from the edge of the upper or lower basket.
- Position quarter segment inserts for test tubes around the middle to leave the corners of the upper or lower basket free.
- Use a cover net to avoid breakages if required.

Chemical processes and technology

In this section you will find a description of the causes of common chemical reactions which can occur between different types of soiling, chemical agents and the components of the machine, along with their remedies as necessary.

This section is intended as a guide. If unforeseen interactions occur during reprocessing, or if you have any queries on this subject, please seek advice from Miele.

General notes	
Problem	How to resolve it
<p>If elastomers (hoses and seals) and plastics in the machine are damaged, this can lead to, for example, swelling, shrinking, hardening or brittleness of materials leading to the development of tears and cracks. Components can then not function correctly and this generally leads to leaks.</p>	<ul style="list-style-type: none"> – Establish the cause of the damage and rectify it. <p>See information regarding "Chemical agents", "Soiling" and "Reaction between chemical agents and soiling".</p>
<p>Heavy foaming during a programme affects cleaning and rinsing results. Foam escaping from the wash cabinet can cause damage to the machine. Cleaning processes cannot be regulated and validated where there has been a build-up of foam.</p>	<ul style="list-style-type: none"> – Establish the cause of the foam and rectify it. – Check the process used regularly to monitor foaming levels. <p>See information regarding "Chemical agents", "Soiling" and "Reaction between chemical agents and soiling".</p>
<p>Corrosion to stainless steel in the wash cabinet and to accessories can give them a different appearance:</p> <ul style="list-style-type: none"> – rust (red marks / discolouration), – black marks / discolouration, – white marks / discolouration (etched surface). <p>Corrosive pitting can lead to the machine not being water-tight. Depending on application corrosion can influence cleaning and rinsing results (laboratory analysis) or cause corrosion to stainless steel items in the cabinet.</p>	<ul style="list-style-type: none"> – Establish the cause of the corrosion and rectify it. <p>See information regarding "Chemical agents", "Soiling" and "Reaction between chemical agents and soiling".</p>

Chemical processes and technology

Chemical agents	
Problem	How to resolve it
<p>The ingredients in chemical agents have a strong influence on the longevity and functionality (throughput) of the dispensing system.</p>	<ul style="list-style-type: none"> – Follow the chemical agent manufacturer's instructions and recommendations. – Carry out a regular visual check of the dispensing system for any damage. – Regularly check the flow rate of the dispensing system. – Ensure that the regular cycle of maintenance is observed. – Please contact Miele Service for advice.
<p>Chemical agents can damage elastomers and plastics in the machine and accessories.</p>	<ul style="list-style-type: none"> – Follow the chemical agent manufacturer's instructions and recommendations. – Carry out a regular visual check of any accessible elastomers and plastics for damage.
<p>The following chemical agents can cause large amounts of foam to build up:</p> <ul style="list-style-type: none"> – Cleaning agents and rinsing agents containing tensides. <p>Foam can occur:</p> <ul style="list-style-type: none"> – in the programme block in which the chemical agent is dispensed, – in the following programme block if it has been spilt, – in the following programme with rinsing agent if it has been spilt. 	<ul style="list-style-type: none"> – Process parameters in the wash programme, such as dispensing temperature, dosage concentration etc. must be set to ensure the whole process is foam free or very low foaming. – Please observe chemical agent manufacturer's instructions
<p>De-foaming agents, especially silicone based ones can cause the following:</p> <ul style="list-style-type: none"> – deposits to build up in the cabinet, – deposits to build up on the load, – damage to elastomers and plastics in the machine, – damage to certain plastics (e.g. polycarbonate and plexiglass) in the load being processed. 	<ul style="list-style-type: none"> – De-foaming agents should be used in exceptional cases only, for instance when absolutely essential for the process. – The wash cabinet and accessories should be periodically cleaned without a load and without de-foaming agent using the Medium or Long programme. – Please contact Miele Service for advice.

Chemical processes and technology

Soiling	
Problem	How to resolve it
<p>The following substances can damage elastomers (hoses and seals) and plastics in the machine:</p> <ul style="list-style-type: none"> – oil, wax, aromatic and unsaturated hydrocarbons, – emollients, – cosmetics, hygiene and care products such as creams (analytical applications). 	<ul style="list-style-type: none"> – Refit the machine with oil resistant elastomers. – Depending on usage wipe the lower door seal on the machine periodically with a lint-free cloth or sponge. Clean the wash cabinet and accessories without a load using the Medium or Long programme. – Use the Medium or Long programme and dispense powder detergent on the door.
<p>The following substances can lead to a heavy build-up of foam during washing and rinsing:</p> <ul style="list-style-type: none"> – some disinfecting agents and dishwashing detergents, – reagents for analysis e.g. for microtiter plates, – cosmetics, hygiene and care products such as shampoos and creams (analytical applications), – active foaming agents such as tensides. 	<ul style="list-style-type: none"> – Thoroughly rinse items in water beforehand. – Select the Long programme (with a cold or hot pre-wash). – Depending on application use de-foaming agents that do not contain silicone oils.
<p>The following substances cause corrosion to stainless steel in the wash cabinet on accessories:</p> <ul style="list-style-type: none"> – hydrochloric acid, – other substances containing chlorides such as sodium chloride etc., – concentrated sulphuric acid, – chromic acid, – particles of iron and swarf. 	<ul style="list-style-type: none"> – Thoroughly rinse items in water beforehand. – Put the drip-dry items to be washed into the mobile units, baskets, modules and inserts and start a programme as soon as possible after placing in the machine.

Chemical processes and technology

Reaction between chemical agents and soiling	
Problem	How to resolve it
Natural oils and fats can be emulsified with alkaline chemical agents. This can lead to a heavy build-up of foam.	<ul style="list-style-type: none">– Select the Medium or Long programme.– Depending on application use de-foaming agents that do not contain silicone oils.
Soiling containing high protein levels such as blood can cause a heavy build-up of foam when processed with alkaline chemical agents.	<ul style="list-style-type: none">– With a cold water connection use the Long programme (cold water pre-wash).– With a hot water connection pre-treat the load as necessary.
Non-precious metals such as aluminium, magnesium and zinc can release hydrogen when processed with very acidic or alkaline chemical agents (oxyhydrogen reaction).	<ul style="list-style-type: none">– Please observe chemical agent manufacturer's instructions

Using chemical agents

⚠ Only use chemical agents designed specifically for use in machine and follow the manufacturer's instructions on their application.

Please observe carefully any instructions relating to non-toxic residues.

⚠ Caution when using chemical agents. Some agents may be corrosive and irritant.

The relevant safety regulations and the chemical agent manufacturer's safety data sheets must be observed.

Wear protective goggles and gloves.



Contact Miele for information about suitable chemical agents.

Highly viscous (thick) chemical agents can affect the dispenser monitoring and lead to inaccurate data. In this instance please contact Miele Service for advice.

The viscosity does not affect dosage concentration levels.

Dispensing systems

The machine is equipped with a number of internal dispensing systems for chemical agents:

- Neutralising agent **or** rinsing agent
This is dispensed via a storage reservoir  in the door.
- Powder cleaning agent
This is dispensed via a detergent dispenser  in the door.

Labelling the siphons

Liquid chemical agents from external containers are dispensed by siphons. Colour coding the siphons can be helpful for correct dispensing.

Miele use and recommend the following:

- Blue: for cleaning agent
- Red: for neutralising agent
- Green: for chemical disinfection agents or an additional second cleaning agent
- White: for acidic chemical agent
- Yellow: for free choice

Adding and dispensing chemical agents

DOS modules

If required an additional external dispensing module (DOS module) can be fitted retrospectively for liquid chemical agents.

External DOS modules are fitted by Miele Service or a suitably qualified and approved technician. Internal dispensing systems cannot be retrospectively fitted.

Connecting a DOS module

The DOS module is supplied with its own installation instructions.

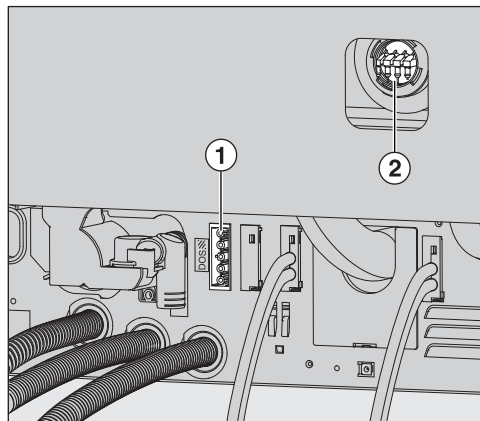

- ① Power supply for DOS 1, cleaning agent.
- ② Connection for dispensing hose.

⚠ Before fitting the DOS module compare the connection data (voltage and frequency) on the data plate with that on the data plate of your machine. If the data does not match, the module could sustain damage. If in any doubt, consult an electrician.

- Connect the module to the electricity supply.
- To connect the dispensing hose, release the hose clip on a free connector and remove the safety cap.
- Push the dispensing hose onto the connector and secure it with a hose clip.

Unused connectors must be blanked off with safety caps to prevent the leakage of wash fluid.

Dispensing liquids For adjusting dispensing concentration see "Further settings / Dispensing systems".

Dispensing neutralising agent or rinsing agent

The reservoir with the ☼ symbol on the lid can either be used for dispensing neutralising agent **or** for rinsing agent.

It is programmed ex-works for neutralising agent.

The machine's controls have to be reprogrammed by Miele Service if you wish to change product, e.g. from neutralising agent to rinsing agent.

Neutralising agent Neutralising agent (pH setting: acidic) neutralises any residues of alkaline cleaning agents on the surface of the load.

Neutralising agent is dispensed automatically in the Interim rinse phase after the main wash (see the "Programme charts"). The reservoir must be filled for this to occur.

Rinsing agent

The dispensing of rinsing agent is deactivated ex-works. Please contact Miele Service if you wish to activate it. If rinsing agent has been activated, neutralising agent will not be dispensed in the Interim rinse phase of the programme.

Rinsing agent is necessary to ensure water does not cling and leave marks on items, and to help items dry faster after they have been washed.

⚠ Residues of rinsing agent remain on the surface of items after they have dried. It is important to check the suitability of the rinsing agent being used.

Rinsing agent is automatically dispensed in the Final rinse phase. The reservoir must be filled for this to occur.

Adding and dispensing chemical agents

Filling the reservoir

⚠ The reservoir must only be filled with the programmed chemical agent - neutralising agent **or** rinsing agent. Do not fill it with cleaning agent. This will damage the reservoir.

- Open the door fully.

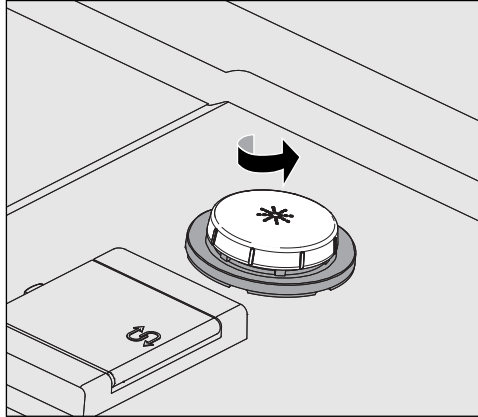

- Unscrew the yellow lid with the  symbol in the direction of the arrow.

The reservoir holds approx. 300 ml.

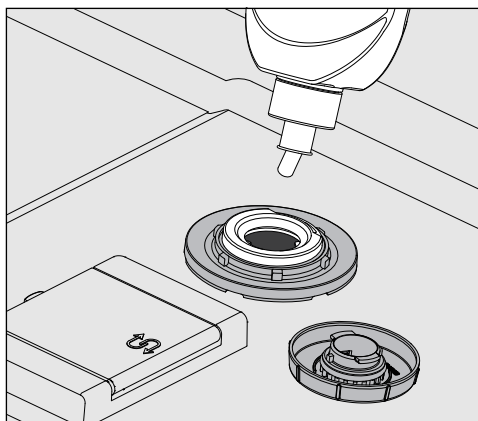

- Add the liquid agent only until it is visible at the "max" mark in the funnel.

Adding and dispensing chemical agents

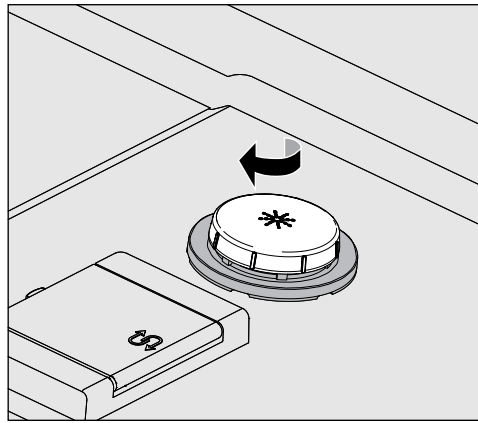

- Close the reservoir.
- Wipe up any spilled process chemical thoroughly.

Refill indicator

When the fill level is low in the (DOS 2) supply container for neutralising or rinsing agent you are reminded to refill it.

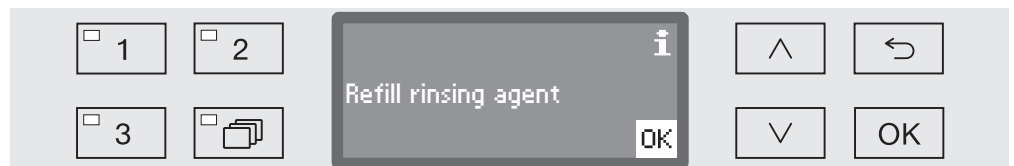

⚠ This message also appears when dispensing neutralising agent. When refilling the reservoir make sure you are using the correct chemical agent.

- Confirm the message shown with *OK* and
- refill the chemical agent as described above.

Dispensing

For adjusting dispensing concentration see "Further settings / Dispensing systems".

If spots appear on items after reprocessing:

- reduce the amount if using **neutralising agent**.
- increase the amount if using **rinsing agent**.

If clouding or smearing appears on items:

- increase the amount if using **neutralising agent**.
- reduce the amount if using **rinsing agent**.

Adding and dispensing chemical agents

Cleaning agent

⚠ Only use cleaning agent which is suitable for commercial dishwashers.
Do not use detergent for domestic dishwashers.

This machine can be used with powder cleaning agent or with liquid cleaning agent via an external DOS module.

DOS modules are fitted by Miele Service and can be retrospectively fitted at any time.

Miele recommend the use of liquid cleaning agent.

For environmental reasons it is important to always consider the following factors when selecting a cleaning agent:

- How alkaline does the cleaning agent need to be for the cleaning application involved?
- For removing pigmentation is active chlorine required for disinfection or oxydation?
- Are tensides required for proper dispersion and emulsification?

For cleaning specific types of soiling, and for information on the optimum cleaning agents and additives to use for liquid dispensing, please contact the Miele Professional Department.

Refilling liquid cleaning agent

Liquid cleaning agent is dispensed from an external supply container e.g. a canister.

- Place the liquid cleaning agent container (blue marking) on the open cabinet door or on a surface which is robust and easy to clean.
- Unscrew and remove the siphon. Place the siphon on the open cabinet door.
- Replace the empty container with a full one.

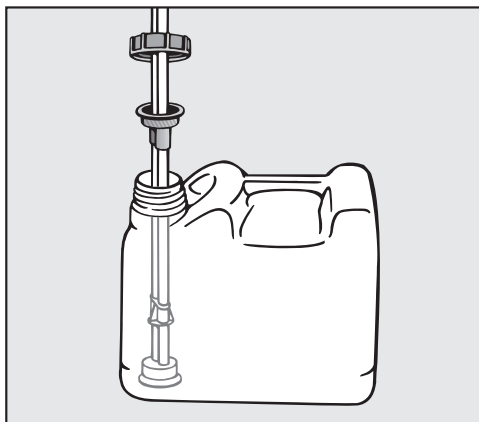

- Push the siphon into the opening of the container and screw it back on tightly. Observe the colour coding.
- Wipe up any spilled process chemical thoroughly.

Adding and dispensing chemical agents

- Place the container on the floor next to the machine or in an adjacent cupboard. Make sure that the dispensing hose is not kinked or trapped.
- Vent the dispensing system as necessary (see "Settings  / Venting DOS").

Checking consumption

Check consumption regularly by checking the fill levels in the supply containers and replace containers in good time to avoid the dispensing system being sucked completely dry.

Refill indicator

When the fill level is low in the DOS 1 supply container for liquid cleaning agent you are reminded to replenish it.

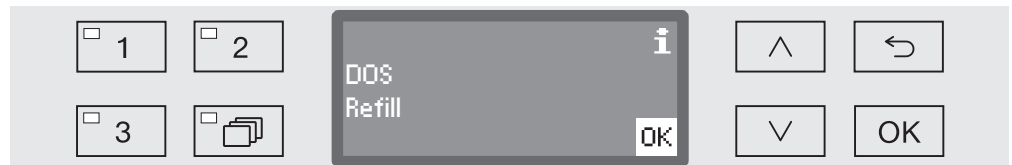

- Confirm the message shown with *OK* and
- replenish the liquid cleaning agent as described.

If the liquid cleaning agent has run out, the machine will be locked for further use.

It will be ready for use again when the supply container has been replaced.

Dispensing liquid cleaning agent

For adjusting dispensing concentration see "Further settings / Dispensing systems".

Adding and dispensing chemical agents

Dispensing powder cleaning agent

⚠ Avoid inhaling powder cleaning agent.
Swallowing chemical agents can cause chemical burns in the mouth and throat or lead to asphyxiation.

Add powder cleaning agent to the dispenser in the door with the  symbol before starting the programme. Do not dispense powder cleaning agent in the Rinsing and Drain programmes.

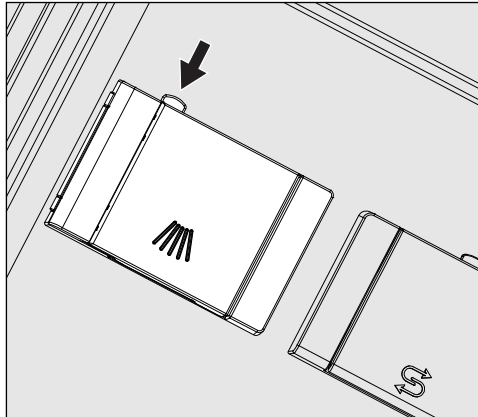

- Press the yellow button on the dispenser with the  symbol.

The flap will spring open. The flap is always open at the end of a programme.

The level markers in the powder dispenser with the door in the horizontal position equate to the amount dispensed in ml. The max. capacity is approx. 60 ml of cleaning agent.

The amount in ml equates to approx. the amount normally recommended in grammes for proprietary powder cleaning agents. Powder density can affect this amount.

Dispensing example:

Approx. 10.5 l of water are taken into the machine for the main wash. With a cleaning agent concentration of approx. 3 g/l you will need approx. 30 g of cleaning agent. Please observe manufacturer's recommendations which may vary!

Adding and dispensing chemical agents

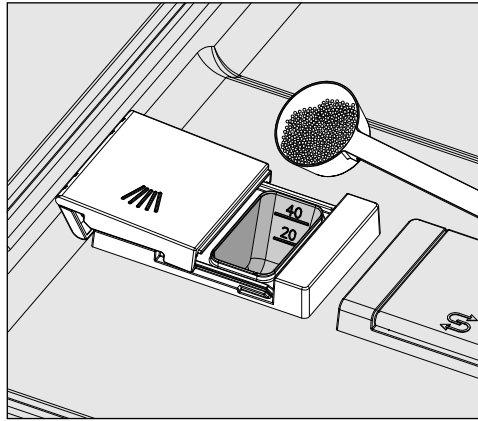

- Add powder agent to the dispenser.

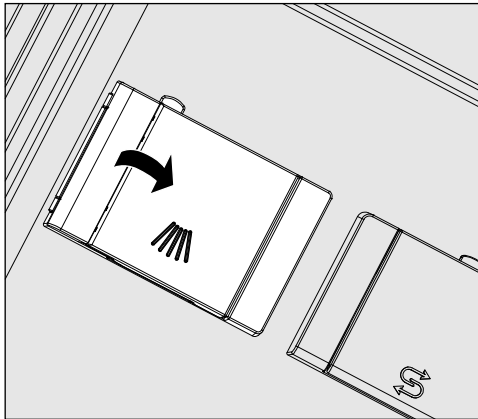

- Close the flap.

⚠ Make sure that all of the cleaning agent has dissolved at the end of the programme.
Repeat the programme if residual agent is present.

Selecting a programme ...

... using the short-cut buttons
... from the programme list

- Select a programme using short-cut buttons **1**, **2** or **3**.
- Press the  button and
- use the \wedge and \vee arrow buttons to highlight a programme and confirm your selection with *OK*.



The LED in the button selected will light up and the relevant programme will appear in the display. The LED in the *Start/Stop* button also starts to flash.

Another programme can be selected at any time before a programme has started. Once it has started, programme selection is locked.

Always select the programme depending on the type of load and degree and type of soiling, or on infection prevention issues.

The programmes and their areas of application are described in the Programme overview at the end of these operating instructions.

Starting a programme

- Close the door.
- Press the *Start/Stop* button.
The LED in the button will light up constantly.

Starting a programme using delay start

The start of a programme can be delayed, for example to benefit from economy rates of electricity. A delay start time between 1 minute and 24 hours can be selected in one minute increments (see "Settings  / Time of day").

Delay start must be released for use in the Settings menu (see "Settings  / Delay start").

Setting the start time

- Select a programme.
- Press the *OK* button before starting the programme.



- Use the arrow buttons \wedge (higher) and \vee (lower) to set the time and confirm your selection with the *OK* button.

When the *OK* button is pressed, the display jumps automatically to the next input position. You cannot go back to the previous entry. If a mistake is made, the process must be cancelled using the \curvearrowright button and repeated.

- Set the minutes using the arrow buttons \wedge (higher) and \vee (lower) and save your entry with *OK*.

The start time is now saved and can be changed as described at any time up to activation of delay start.

Activating delay start

- Delay start is activated with the *Start/Stop* button.

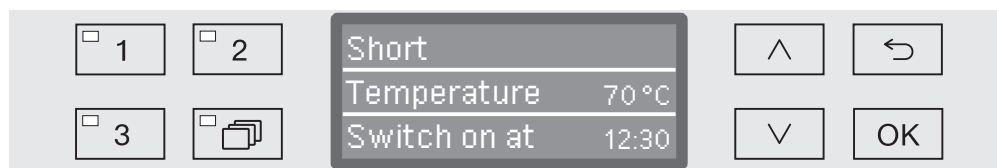

The selected programme with the start time set is shown in the display. If the automatic switch off after function has been activated (see "Further settings / Switch off after"), the dishwasher will switch itself off after the set time until the programme start time set is reached.

Deactivating delay start

- Press the \curvearrowright button.

Programme sequence indicator

After the programme has started the programme sequence can be followed in the three-line display

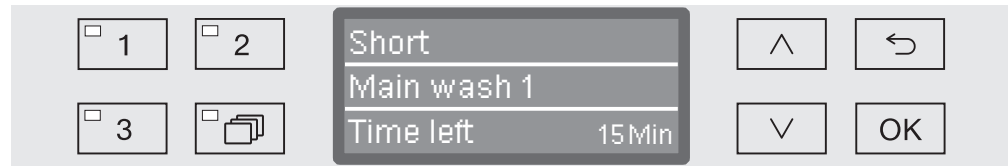

Top line – Programme name.

Middle line The following parameters can be checked using the arrow buttons \wedge and \vee :

- Current programme block, e.g. Main wash 1,
- Actual or required temperature (depending on the display set, see "Further settings / Display: Temperature").
- Cycle number

Bottom line – Time left (in hours; under an hour, in minutes)

At the end of the programme

A programme is usually finished when the following parameters and messages are shown in the display:

Top line – Programme name.

Middle line Continuously alternating between:

- (Parameter met/not met)
- Cycle number

Bottom line – Programme finished

The LED in the *Start/Stop* button also goes out. In the factory default state an acoustic tone also sounds for approx. 10 seconds (see "Settings \blacktriangledown / Volume").

Cancelling a programme

⚠ Be careful when opening the door.
The wash load could be hot. Danger of scalding, burning and chemical burns.

Programme cancelled due to a fault

The programme stops and an error message appears in the display. Take appropriate steps to resolve the fault, depending on its cause (see "Problem solving guide").

Cancelling a programme manually

A programme which is already running should only be cancelled if strictly necessary, e.g. if the wash load is moving about significantly.

- Open the door.

After that, the display will show the following:



- Rearrange the items so that they are stable.
- Close the door.

The programme will continue from where it left off and the display will revert to show the programme sequence.

Restarting the programme

- Before starting the programme, check to see whether any more powder cleaning agent is required.
- Start the programme again or select a new programme.

The structure of the Settings  menu is shown below. The menu incorporates all relevant functions to support daily routine tasks.





In the structure overview all options which can be permanently selected have boxes beside them. Factory settings are indicated by a tick . You will find an explanation of how to change settings after the overview.

Settings

- ▶ Delay start
 - ▶ No
 - ▶ Yes
- ▶ DOS venting
 - ▶ DOS_
- ▶ Language 
 - ▶ deutsch
 - ▶ english (GB)
 - ▶ ...
- ▶ Date
 - ▶ Date format
 - ▶ DD:MM:YY
 - ▶ MM:DD:YY
 - ▶ Set
- ▶ Time of day
 - ▶ Set
 - ▶ Display
 - ▶ On
 - ▶ On for 60 seconds
 - ▶ Do not display
 - ▶ Clock display
 - ▶ 12 h
 - ▶ 24 h
- ▶ Volume
 - ▶ Keypad tone
 - ▶ Buzzer tones
 - ▶ Programme end
 - ▶ Warning

Delay start

This setting must be activated for delay start to be available for use.

- Open the systems menu by switching the machine off with the  button and then with the  held in switch it back on with the  button.
- Open the menu as follows:
 - ▶ Settings 
 - ▶ Delay start

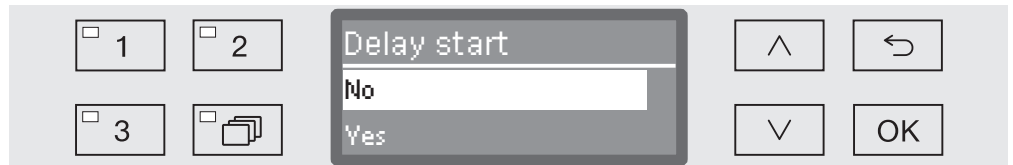

- No
Delay start is deactivated.
 - Yes
Delay start is activated and can be used for all programmes.
- Select an option using the \wedge and \vee arrow buttons.
 - Press *OK* to save the setting.





DOS venting

The dispensing system for liquid chemical agents can only dispense reliably if the system has been purged of air.

The DOS system must only be vented:

- if the dispensing system is being used for the first time,
- if the liquid cleaning agent container was not refilled or replaced in time and the DOS system was sucked dry.

Before venting, ensure that the liquid chemical agent container is sufficiently full and the siphons are securely screwed to the containers. Only one DOS system can be vented at a time.

- Open the systems menu by switching the machine off with the  button and then with the  held in switch it back on with the  button.
- Open the menu as follows:
 - ▶ Settings 
 - ▶ DOS venting
 - ▶ DOS... (name of dispensing system)



Automatic venting will start when the dispensing system is selected. Once started, the automatic venting process can no longer be cancelled.



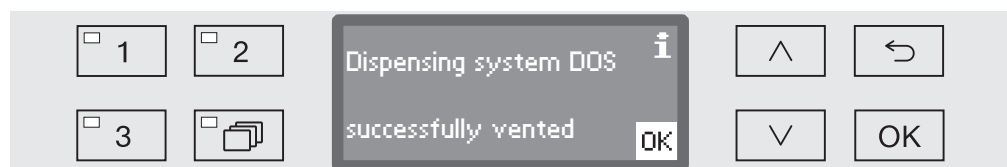

- Select a dispensing system using the \wedge and \vee arrow buttons.
- Press *OK* to start the venting process.



Automatic venting is successfully completed when the following message appears in the display:



Language

The language set will be used in the display.

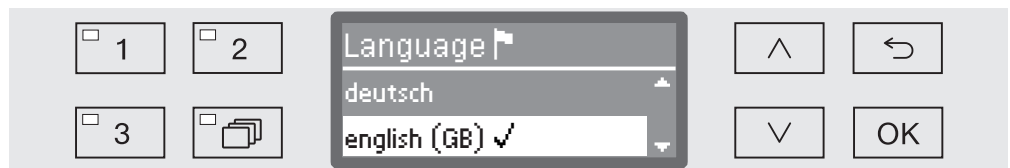

- Open the systems menu by switching the machine off with the  button and then with the  held in switch it back on with the  button.
- Open the menu as follows:
 - ▶ Settings 
 - ▶ Language 

The flag symbol  after the Settings  and Language  menu options acts as a guide if a language which you do not understand has already been set.



A list will appear in the display with all the languages available. The currently selected language has a tick ✓ beside it.

The factory default language is set as english (GB).

- Use the  and  arrow buttons to select the language you want.
- Press *OK* to save the setting.





The display will change immediately to the language selected.

Date



The date is required e.g. for process documentation. The date format and the current date have to be set.

Select the date format

The selected date format appears in the display and in the process documentation.

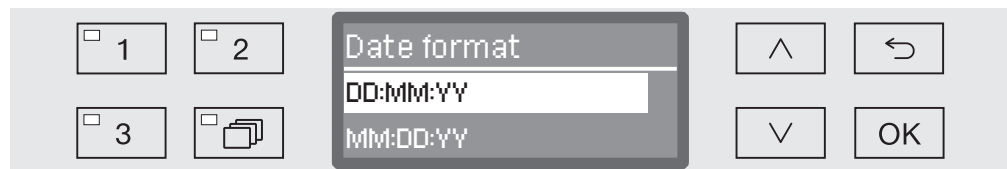

- Open the systems menu by switching the machine off with the  button and then with the  held in switch it back on with the  button.
- Open the menu as follows:
 - ▶ Settings 
 - ▶ Date
 - ▶ Date format



- DD = Day
- MM = Month
- YY = Year.
- Use the  and  arrow buttons to select the date format you want.
- Press *OK* to save the setting.

Set the date

The current date will be set in the selected date format.

- Open the systems menu by switching the machine off with the  button and then with the  held in switch it back on with the  button.



- Open the menu as follows:

▶ Settings 



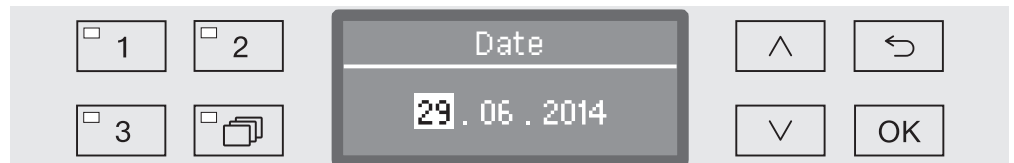

▶ Date

▶ Set



- Use the arrow buttons  (higher) and  (lower) and confirm your entry using the *OK* button.

When the *OK* button is pressed, the display jumps automatically to the next input position. You cannot go back to the previous entry. If a mistake is made, the process must be cancelled using the  button and repeated.

- Use the arrow buttons  (higher) and  (lower) to set the month/day and confirm your entry using the *OK* button.
- Use the arrow buttons  (higher) and  (lower) to set the year and press the *OK* button to save the date.

The date will be saved when the *OK* button is pressed for the last time.





Time of day

The time of day is required for process documentation, delay start, the machine log book and the display. The date format and the current time of day have to be set.

There is no automatic adjustment between summer and winter time (daylight savings).
You need to make this adjustment yourself as necessary.

Selecting the time of day format

To set the format for the time of day in the display:

- Open the systems menu by switching the machine off with the  button and then with the  held in switch it back on with the  button.
- Open the menu as follows:
 - ▶ Settings 
 - ▶ Time of day
 - ▶ Clock display





– 12 h

Time of day in 12 hour format (am/pm).



– 24 h

Time of day in 24 hour format.

- Use the  and  arrow buttons to select the date format you want.
- Press *OK* to save the setting.

Set the time of day



To set the format for the time of day:

- Open the systems menu by switching the machine off with the  button and then with the  held in switch it back on with the  button.

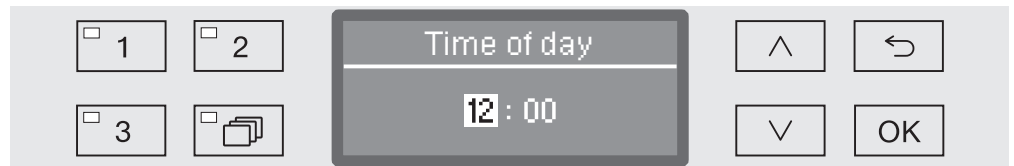

- Open the menu as follows:

- ▶ Settings 
- ▶ Time of day
- ▶ Set



- Use the arrow buttons  (higher)  (lower) to set the hours and confirm your entry with the *OK* button.





When the *OK* button is pressed, the display jumps automatically to the next input position. You cannot go back to the previous entry. If a mistake is made, the process must be cancelled using the  button and repeated.

- Use the arrow buttons  (higher) and  (lower) to set the minutes and press the *OK* button to save the time of day.

The time of day will be saved when the *OK* button is pressed for the last time.

Display

The time of day can, if required, be displayed when the machine is switched off.



- Open the systems menu by switching the machine off with the  button and then with the  held in switch it back on with the  button.
- Open the menu as follows:
 - ▶ Settings 
 - ▶ Time of day
 - ▶ Display



- On
Time of day is constantly displayed when the machine is switched off.
- On for 60 seconds
Time of day is displayed for 60 seconds when the machine is switched off.
- Do not display
The display is switched off.
- Select an option using the \wedge and \vee arrow buttons.
- Press *OK* to save the setting.

Volume

A buzzer which is integrated into the control panel can give an acoustic signal in the following situations:

- When buttons are pressed (keypad tone)
- At the end of the programme
- System messages (information)
- Open the systems menu by switching the machine off with the  button and then with the  held in switch it back on with the  button.

- Open the menu as follows:

- ▶ Settings 
- ▶ Volume

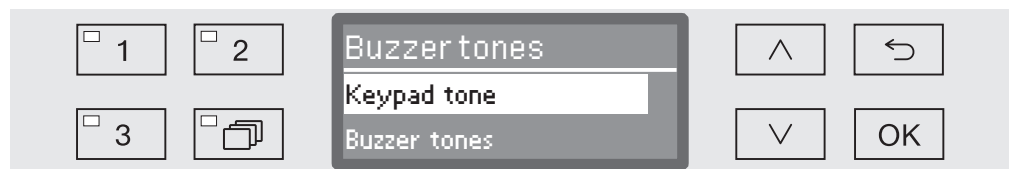

- Buzzer tones

Setting the buzzer volume for programme end and system messages (information)

- Keypad tone

Setting the buzzer volume for keypad tone.

- Select an option using the \wedge and \vee arrow buttons.
- Confirm your selection with *OK*.

When Keypad tone has been selected you can adjust the volume immediately. When Buzzer tones has been selected you must first select which tone, Warning or Programme end, you would like to adjust the volume for.

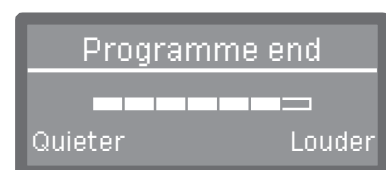
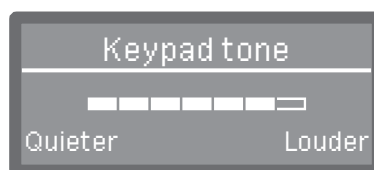

The volume level is represented by a bar chart. On the lowest setting the buzzer tone is switched off.

- Use the arrow buttons \wedge (Louder) and \vee (Quieter) to set the volume.
- Press *OK* to save the setting.

Further settings

The Further settings menu incorporates all administrative processes and settings.

The Further settings menu can only be accessed by using a code. If you do not have the code, contact a user with appropriate access rights or cancel the process using the ↩ button.

In the structure overview all options which can be permanently selected have boxes beside them. Factory settings are indicated by a tick . You will find an explanation of how to change settings after the overview.

Further settings

- ▶ Code
 - ▶ Release
 - ▶ Further settings
 - ▶ Block
 - ▶ Yes
 - ▶ Change code
- ▶ Log book
 - ▶ Consumption: Water
 - ▶ Consumpt.: Cleaning agent
 - ▶ Consumpt.: Rinsing agent
 - ▶ Operating hours
 - ▶ Wash cycles
 - ▶ Service interval
- ▶ Temperature unit
 - ▶ °C
 - ▶ °F
- ▶ Move programme
 - 1 Short
 - 2 Medium
 - 3 Long
- ▶ Additional functions
 - ▶ Reset
 - ▶ Increased water level
 - ▶ Interim rinse
 - ▶ Dispensing system
 - ▶ Active
 - ▶ Inactive
 - ▶ DOS venting
 - ▶ Concentration
 - ▶ Change name
 - ▶ Temperature / time
 - ▶ ...

- ▶ Release programme
 - ▶ All
 - ▶ Selection
 - ▶ ...
- ▶ Water hardness ⇨ 19
- ▶ Display view
 - ▶ Actual temperature
 - ▶ Required temperature
- ▶ Display
 - ▶ Contrast
 - ▶ Brightness
- ▶ Switch off after
 - ▶ Yes
 - ▶ No
- ▶ Factory default
 - ▶ Reset
 - ▶ Programme settings only
 - ▶ All settings
 - ▶ No
- ▶ Software version
 - ▶ EB ID XXXX
 - ▶ EGL ID XXXX
 - ▶ EZL ID XXXX
 - ▶ EFU ID XXXX

Further settings

Code

The Further settings menu incorporates relevant functions and system settings which require an enhanced knowledge of machine reprocessing. Access to the menu can therefore be protected by a four digit code.

It is not possible to block individual options or the inputting of multiple codes at the same time.

 If a code is lost, a new code must be issued by Miele Service.

Enter code

If access to the Further settings menu is blocked, you will be prompted to enter the code when it is selected.



If you do not have the code, contact a user with appropriate access rights or cancel the process using the  button.

- Use the arrow buttons \wedge (higher) and \vee (lower) to enter the relevant digits.
- Confirm each digit individually with the *OK* button.

When the *OK* button is pressed, the display jumps automatically to the next input position. You cannot go back to the previous entry. If a mistake is made, the process must be cancelled using the  button and repeated. Entered digits are replaced by a * symbol.

If all digits are entered correctly the menu will be released.

If an incorrect entry is made, an error message will appear.





- Confirm the message with *OK*.

Access remains blocked and the display reverts to the menu selection.

Release

The following function can be used to restrict access to the Further settings menu via a code or to take the restriction off.

- Open the Further settings menu by switching the machine off with the  button and then switch it on again with the  button whilst keeping the  button held in.

- Open the menu as follows:

- ▶ Further settings
 - ▶ Code
 - ▶ Release
 - ▶ Further settings



- Block

The menu is only accessible by using a code.

- Yes

The menu is available to all users.



- Select an option using the \wedge and \vee arrow buttons.
- Press *OK* to save the setting.

Further settings

Change code

The code consists of a four digit number and is set by the user. Each digit can be programmed freely between 0 and 9.

⚠ When a new code is entered the old code is overwritten and is permanently deleted. Therefore it cannot be reinstated.
If a code is lost, a new code must be issued by Miele Service.

- Open the Further settings menu by switching the machine off with the  button and then switch it on again with the  button whilst keeping the  button held in.
- Open the menu as follows:
 - ▶ Further settings
 - ▶ Code
 - ▶ Change code



- Use the arrow buttons \wedge (higher) and \vee (lower) to enter the relevant digits.
- Confirm each digit individually with the *OK* button.



When the *OK* button is pressed, the display jumps automatically to the next input position. You cannot go back to the previous entry. If a mistake is made, the process must be cancelled using the  button and repeated. Entered digits are replaced by a * symbol.

The code is saved to memory once you have confirmed the last digit.

Log book

The entire life cycle of the machine, including consumption data for water and chemical agents, as well as operating hours and programme cycles are recorded in the log book.

Miele Service can also use the log to calculate a recommendation for service intervals.



- Open the Further settings menu by switching the machine off with the  button and then switch it on again with the  button whilst keeping the  button held in.

- Open the menu as follows:

- ▶ Further settings

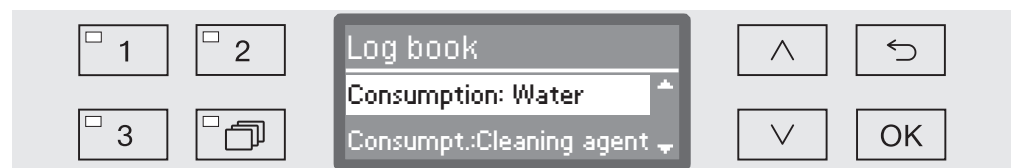
- ▶ Log book



- Consumption: Water
Display the total amount of water used in litres (l).
 - Consumpt.:Cleaning agent
Display the total amount of liquid cleaning agent used in litres (l).
Powder cleaning agent is not shown.
 - Consumpt.: Rinsing agent
Display total consumption of neutralising agent or rinsing agent in litres (l).
 - Operating hours
Display the total number of operating hours.
 - Programme cycle counter
Total of all completed programmes. There is no breakdown of individual programmes. Cancelled programmes are not included.
 - Service interval
Date of the next service (entered by Miele Service).
- Select an option using the  and  arrow buttons and save your choice with *OK*.

Values in the machine log cannot be altered.

- Press the  button to exit the menu.



Further settings

Temperature unit

During a programme the temperature display is refreshed every 2 to 5 seconds depending on the programme stage. The temperature can be displayed in degrees Celsius (°C) or Fahrenheit (°F).

The temperature unit is set at the factory to °C.

When the temperature unit is changed to °F, the temperature displayed is automatically recalculated.

- Open the Further settings menu by switching the machine off with the  button and then switch it on again with the  button whilst keeping the  button held in.
- Open the menu as follows:
 - ▶ Further settings
 - ▶ Temperature unit

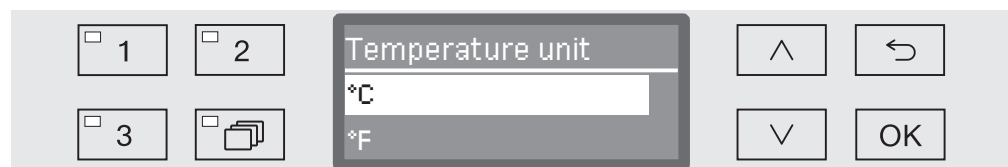

– °C

Display temperature in degrees Celsius.



– °F

Display temperature in degrees Fahrenheit.

- Select an option using the \wedge and \vee arrow buttons.
- Press *OK* to save the setting.

Moving a programme: allocating programme selection buttons

You can sort the programme selection list to suit your requirements and therefore also allocate the programme selection buttons 1, 2 and 3.

- Open the Further settings menu by switching the machine off with the  button and then switch it on again with the  button whilst keeping the  button held in.

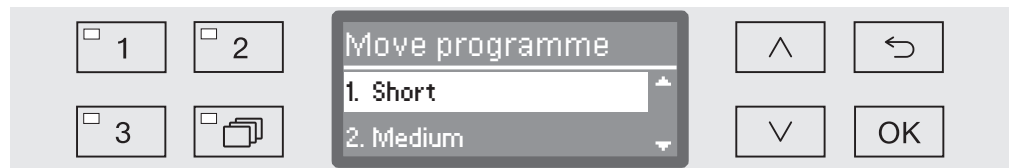

- Open the menu as follows:

- ▶ Further settings
- ▶ Move programme





All released programmes are shown in the programme list (see "Further settings / Programme release"). A programme's position in the programme list is decisive for allocating the programme selection buttons. Programmes are numbered from 1 - n. The first three programmes in the list are allocated to the programme selection buttons.

- 1. Short on programme selection button 1
- 2. Medium on programme selection button 2
- 3. Long on programme selection button 3
- 4. Demineralised rinse
- 5. Rinsing
- etc.

- Use the  and  arrow buttons to select the programme you would like to move.

- Confirm your selection with *OK*.

Now you can move this programme within the list.

- Use the  and  arrow buttons to move the programme to the position you want.

- Press *OK* to save the programme to the selected position.

The programme which was previously saved to this position and all subsequent programmes are moved down by one position.

The process can be repeated as often as you wish.

- Press the  button to exit the menu.



Further settings

Additional functions

You can use this menu to customise the current programme to suit technical requirements and the wash load or to reset all additional functions to the factory default settings.

Additional specialist knowledge is required to alter programme settings and this should therefore be undertaken only by experienced users or by Miele Service.

Changing programme parameters on a validated machine will necessitate a renewed performance validation.

- Open the Further settings menu by switching the machine off with the  button and then switch it on again with the  button whilst keeping the  button held in.
- Open the menu as follows:
 - ▶ Further settings
 - ▶ Additional functions

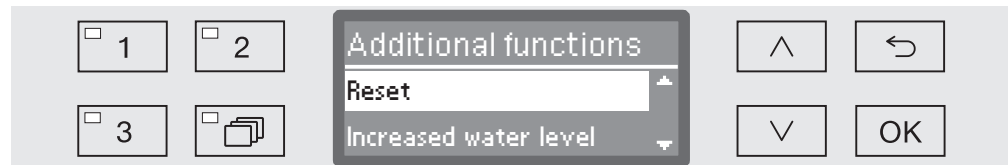

- Reset

All parameters that have been set under "Additional functions" will be reset to the factory default setting.

- Increased water level

The water level will be increased for all programmes.

- Interim rinse



All programmes that this option is intended for will have an extra interim rinse stage (see the programme chart).

- Dispensing system

Venting the dispensing system and renaming it.

- Temperature / time

Adjust the temperature and holding time for the Main wash 1 or Final rinse 1 programme block.

- Use the  and  arrow buttons to select an option and confirm your selection with **OK**.

See the next section for details of how to continue.

Reset

You can reset altered additional function parameters back to their default settings if necessary. This does not apply to further settings.

...

▶ Reset



– No

Altered parameters are maintained.

– Yes

All parameters will be reset to the factory default setting.

■ Select an option using the \wedge and \vee arrow buttons.

■ Press *OK* to save the setting.

Further settings

Increased water level

Increasing the water level is advisable if a large amount of water clings to items due to the structure of the wash load or if a heavy build-up of foam might occur due to the type of soiling (e.g. blood) and the chemical agents used. The additional amount of water required depends on the type of basket or mobile unit used, the type of soiling and the load.

...

► Change volume of water

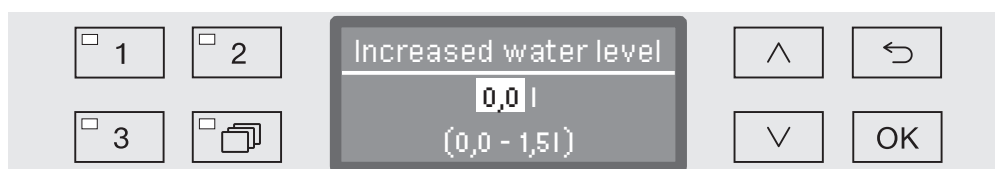

The water quantity can be increased in 0.5 l increments. The possible range is shown in the bottom line.

- Use the arrow buttons \wedge (higher) and \vee (lower) to alter the water quantity.
- Press *OK* to save the setting.

Interim rinse

Some programmes can have the option of adding an extra interim rinse (see "Programme chart").

...

► Interim rinse



– No

The additional interim rinse block is deactivated.

– Yes

The additional interim rinse block is activated for all applicable programmes.

- Select an option using the \wedge and \vee arrow buttons.
- Press *OK* to save the setting.

Dispensing systems

Individual dispensing systems can be activated or deactivated for all programmes as follows.

...

▶ Dispensing system

▶ DOS... (name of dispensing system)



– Active

The selected dispensing system is activated. Dispensing will only occur in the appropriate wash blocks (see Programme charts).

– Inactive

The selected dispensing system is deactivated for all programmes.

■ Select an option using the ^ and v arrow buttons.

■ Press *OK* to save the setting.

If the dispensing systems have been activated (Active) the following options are also available:

– DOS venting

Vent the dispensing system.

– Concentration

Set the dosage concentration level. The setting applies to all programmes.

– Change name

Change the name of the dispensing system.

With DOS 2 Rinsing agent the only option shown is Concentration.

Further settings

DOS venting

The dispensing system for liquid chemical agents can only dispense reliably if the system has been purged of air.

The DOS system must only be vented:

- if the dispensing system is being used for the first time,
- if the liquid cleaning agent container was not refilled or replaced in time and the DOS system was sucked dry.

Before venting, ensure that the liquid chemical agent container is sufficiently full and the siphons are securely screwed to the containers. Only one DOS system can be vented at a time.

...

- ▶ Dispensing system
 - ▶ DOS_
 - ▶ DOS venting



Automatic venting will start when the dispensing system is selected. Once started, the automatic venting process can no longer be cancelled.

- Select a dispensing system using the \wedge and \vee arrow buttons.
- Press *OK* to start the venting process.

Automatic venting is successfully completed when the following message appears in the display:

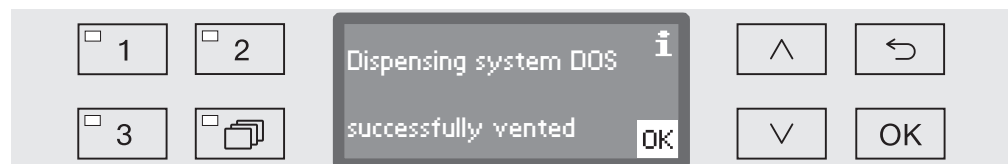

Concentration

Dispensing concentration for liquid chemical agents, e.g. in the case of a change of manufacturer, can be adjusted for all programmes at once.

Dispensing concentration must be set in accordance with the manufacturer's instructions or with the required processing result.

Consumption of liquid agents is recorded in the log book (see "Further settings / Log book").

...

▶ Dispensing system

▶ DOS_

▶ Concentration

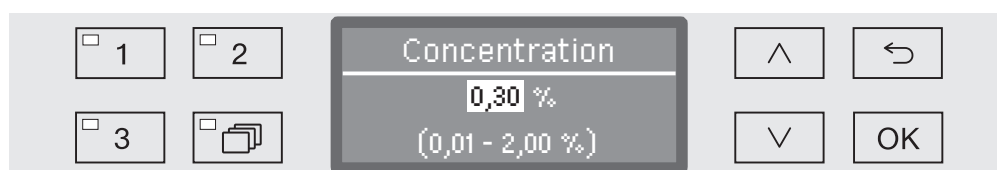

Dispensing concentration can be adjusted in increments of 0.01. The possible range is shown in the bottom line of the display.

- Set the concentration using the arrow buttons \wedge (higher) and \vee (lower).
- Press *OK* to save the setting.

Further settings

Change name

If required the names of the dispensing systems "DOS1", "DOS2" etc. can be extended to include additional information e.g. "DOS1 cleaning agent". The name "DOS" and the accompanying number cannot be changed.

Use this option to document all changes to factory settings in case of a subsequent Service call requirement.

If the option





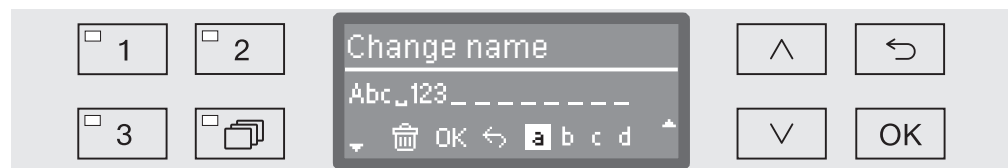

- Change name

has been selected, the display changes to the following view:



The current name is shown on the second line of the display. This can be changed using the options shown in the bottom line. The top line shows which option has been selected from the bottom line.

Names may consist of up to 15 characters including spaces. The following options are available:

- Letters from A to Z,
each new word will start with a capital letter.
- Numbers from 0 to 9.
- Space _.
- Use the  symbol to delete the last position.
- The name is saved when the  symbol in the display is selected. The display will then revert to the initial menu.
- The  symbol in the display or the  button end the process without saving the name change. The display reverts to the initial menu.
- Use the arrow buttons  (right) and  (left) to move the cursor to the option you require.
- Confirm each entry with *OK*.

Temperature / Time

You now have the option of adjusting the temperature and holding time in the main wash and final rinse stages of individual programmes.

...

► Temperature / time

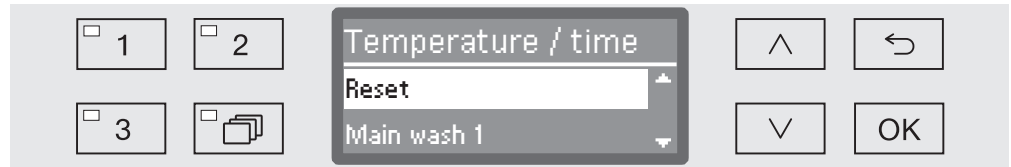

– Reset

The parameters in all programmes will be reset to their default settings.

– Main wash 1

Temperature and holding time is adjusted for this programme block.

– Final rinse 1

Temperature and holding time is adjusted for this programme block.

■ Select an option using the \wedge and \vee arrow buttons and confirm your selection with *OK*.

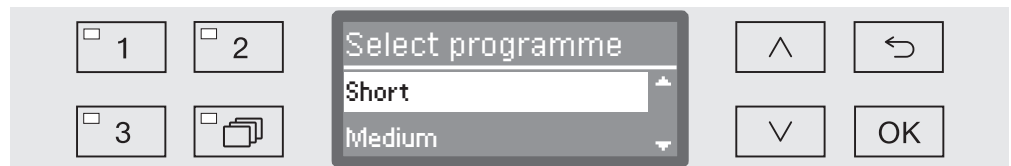

■ Then use the \wedge and \vee arrow buttons to select the programme and confirm your selection with *OK*.

If you select *Reset* the programme selected will be reset to its default settings and the menu will be closed.

Further settings

If you select Main wash 1 or Final rinse 1, the following settings can be altered:

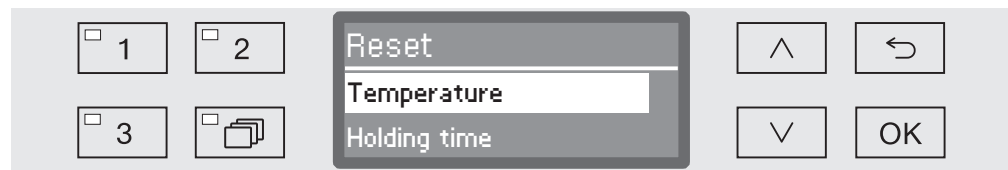

– Temperature / Final rinse temp.

The temperature of the selected block can be altered.

– Holding time

The holding time of the selected block can be altered.

- Select an option using the \wedge and \vee arrow buttons and confirm your selection with *OK*.

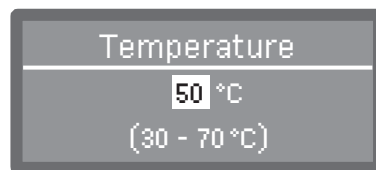



Adjustment is in increments of 1. The possible range is shown in the bottom line.

Dispensing of chemical agents occurs at a default dispensing temperature set at the factory. If chemical agents are to be dispensed in this wash block, the lowest temperature that can be set will be the dispensing temperature. It is not possible to set a lower value.

- Use the arrow buttons \wedge (higher) and \vee (lower) to set the value.
- Press *OK* to save the setting.

Release programme

It is possible to block access to individual programmes. Blocked programmes are not available for selection, so for example it can be ensured that only validated programmes are used.

- Open the Further settings menu by switching the machine off with the  button and then switch it on again with the  button whilst keeping the  button held in.
- Open the menu as follows:
 - ▶ Further settings
 - ▶ Release programme

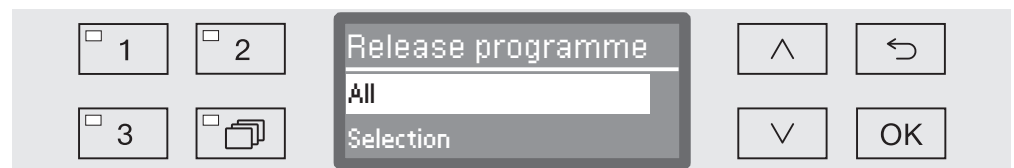

– All

All programmes are released for use.

– Selection

A selection of programmes are available for use.

- Select an option using the \wedge and \vee arrow buttons and confirm your selection with *OK*.

The Selection option displays a list of all programmes.

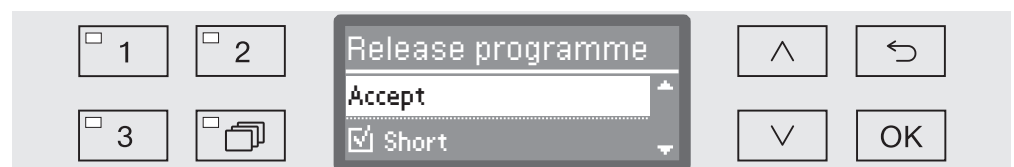

Programmes are selected by multiple choice. A box is shown next to all programmes in the list. If a programme is released, there is a tick in the box. An empty box indicates a blocked programme.

- Programmes can be released or blocked using the arrow buttons \wedge and \vee and by confirming with *OK*.
- To save the selection select the *Accept* option at the end of the list and confirm with *OK*.

Further settings



Water hardness

You can use this menu to set the water softener to the water hardness of the mains supply.

For more information see "Water softener".

Display: Temperature

The wash cabinet temperature can be viewed during a programme. Either the current actual temperature or the required temperature which has been preset for the current wash block is displayed.

- Open the Further settings menu by switching the machine off with the  button and then switch it on again with the  button whilst keeping the  button held in.
- Open the menu as follows:
 - ▶ Further settings
 - ▶ Display view

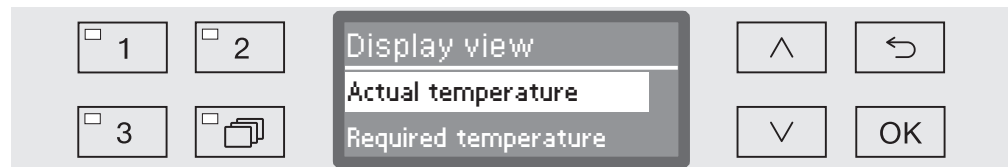



- Actual temperature

Display the current actual temperature in the wash cabinet.

- Required temperature



Display the required temperature which has been preset for the current wash block. If a temperature has not been set, a dotted line --- is shown.

During a programme both settings are displayed together as Temperature. There is no breakdown of actual and required temperature.

- Select an option using the  and  arrow buttons.
- Press *OK* to save the setting.

Display brightness and contrast

You can use this menu to adjust the brightness and contrast of the display.

- Open the Further settings menu by switching the machine off with the  button and then switch it on again with the  button whilst keeping the  button held in.
- Open the menu as follows:
 - ▶ Further settings
 - ▶ Display

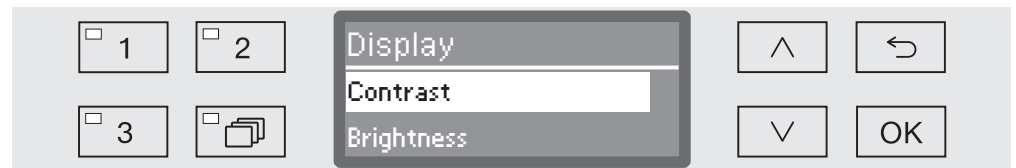

- Contrast
 - Set the contrast.
- Brightness
 - Set the brightness.
- Select an option using the \wedge and \vee arrow buttons.
- Confirm your selection with *OK*.





Contrast and brightness are shown as a bar chart in the display.

- Use the arrow buttons \wedge (Higher/Brighter) and \vee (Lower/Darker) to set the brightness and contrast you want.
- Press *OK* to save the setting.

Further settings

Switch off after (Auto-Off function)

If the machine has not been used for a specific duration, it switches itself off automatically. Automatic switch-off can be optionally activated and deactivated.

- Open the Further settings menu by switching the machine off with the  button and then switch it on again with the  button whilst keeping the  button held in.
- Open the menu as follows:
 - ▶ Further settings
 - ▶ Switch off after

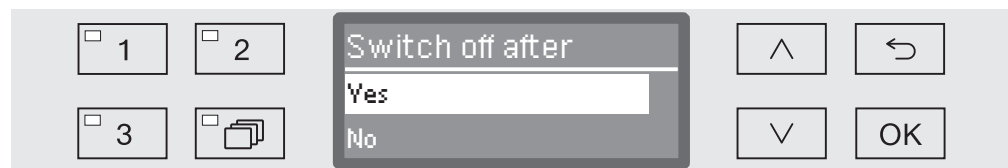

– Yes

The Auto-Off function is activated. A duration must be set after which automatic switch-off should occur.

– No

The Auto-Off function is deactivated.

- Select an option using the \wedge and \vee arrow buttons.
- Press *OK* to save the setting.

Setting the standby duration

If the *Yes* option is displayed, the standby duration after which automatic switch-off should occur must be set next.

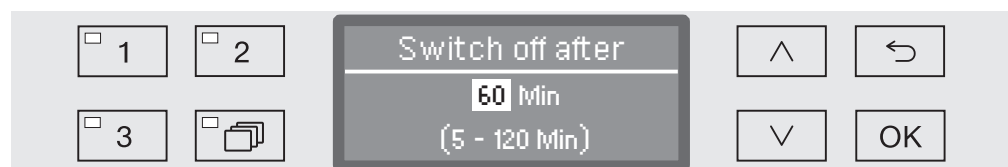



The standby duration can be adjusted in 5 minute increments. The possible range is shown in the bottom line of the display.

- Use the \wedge (higher) and \vee (lower) arrow buttons to set the standby duration.
- Press *OK* to save the setting.

Factory default

All parameters which have been altered can be reset to their default settings. Control parameters and programme settings are reset separately.

- Open the Further settings menu by switching the machine off with the  button and then switch it on again with the  button whilst keeping the  button held in.
- Open the menu as follows:
 - ▶ Further settings
 - ▶ Factory default
 - ▶ Reset



- No
Altered parameters are maintained.
- Programme settings only
All programme settings are reset.

Programmes saved on free memory locations remain unchanged.

- All settings
All control parameters including dispensing quantities and water hardness will be reset.
- Select an option using the \wedge and \vee arrow buttons.
- Confirm your selection with *OK*.

Software version

You can use this menu to call up the software versions of individual elements, e.g. when contacting Miele Service.

For more information see "Service".

Periodic checks

The machine should be serviced **every 1000 hours of operation, or at least once a year** by Miele Service.

This maintenance will cover the following:

- Electrical safety according to national regulations (VDE 0701/0702 in Germany)
- Door mechanism and door seal
- Any screw connections and connectors in the wash cabinet
- Water inlet and drainage
- Internal and external dispensing systems
- Spray arms
- Filter combination
- Sump including drain pump and non-return valve
- All mobile units, baskets, modules and inserts

The following operational tests will be carried out within the framework of the maintenance:

- A programme will be run as a test run
- Thermo electrical measurements will be taken
- Seals will be tested for water tightness
- All relevant measuring systems will be safety tested including error message displays.
- Safety features

Routine checks

Before the start of each working day the user must carry out a number of routine checks. A check list is supplied with the machine for this purpose.

The following need to be inspected:

- All filters in the wash cabinet
- The spray arms in the machine and in any mobile units or baskets
- The wash cabinet and the door seal
- The dispensing systems and
- Mobile units, baskets, modules and inserts.

Cleaning the filters in the wash cabinet

The filters in the floor of the wash cabinet prevent coarse soiling from coming into contact with the circulation system. Filters can become blocked by soiling, so they need to be checked every day and cleaned as necessary.

 This machine must not be used without all the filters in place.

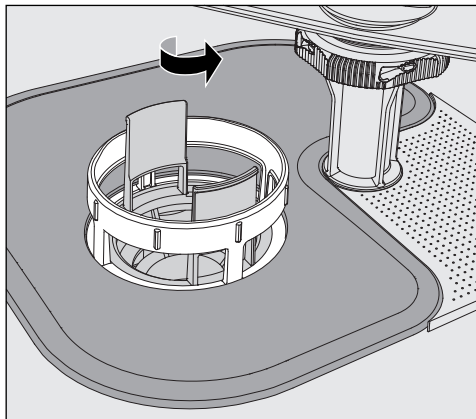

 Danger of injury from glass shards, needles etc which are retained in the filter.

- Turn the microfine filter in the direction of the arrow and remove it together with the coarse filter.

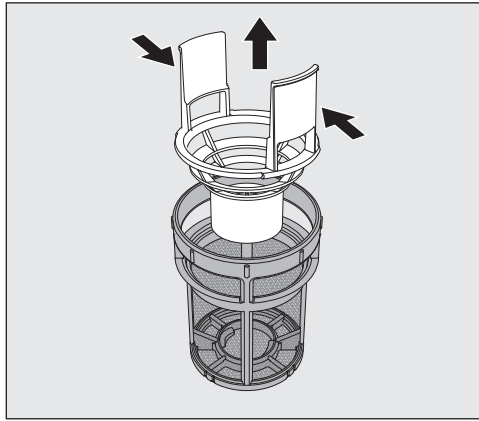

- Press the catches towards each other and pull the coarse filter upwards to remove it.
- Remove the fine filter which sits loosely between between the coarse filter and the microfine filter.

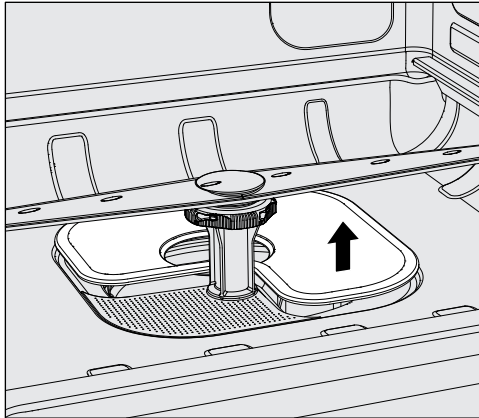

- Remove the flat filter last.
- Clean the filters.
- Re-insert the filter combination in the reverse order. Ensure ...
 - ... that the flat filter sits flat in the base of the wash cabinet.
 - ... that the coarse filter has securely clicked into place in the microfine filter.
 - ... that the microfine filter is tightly screwed in as far as it will go.

Cleaning the spray arms

The spray arms can become blocked, especially if the filters are not inserted correctly in the wash cabinet. This can cause coarse particles of soiling to get into the wash fluid circulation.

The spray arms must be visually checked daily for any soiling.

- To do this remove the mobile unit and the baskets.
- Visually check the spray arms for soiling and blocked jets.
- Also check that the spray arms can turn easily.

⚠ Immobile or blocked spray arms must not be used again.
In this case contact Miele Service.

Cleaning the spray arms

The spray arms in the machine as well as in the mobile units and baskets must be fully dismantled for cleaning:

- Remove the mobile unit or baskets from the machine.

The machine upper spray arm is connected by a push-fit connector.

- Pull the machine upper spray arm downwards to remove it.

The machine lower spray arm and the spray arms in the mobile units and baskets are secured with bayonet fittings.

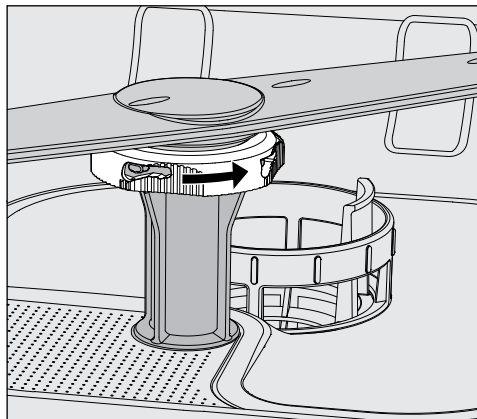

- To release the knurled bayonet fittings, turn them in the direction of the arrow as far as they will go.
- Then the spray arms can be removed by pulling them upwards or downwards.

Mobile unit and basket spray arms with knurled nuts:

The spray arms of older types of mobile units and baskets are secured with knurled nuts. These must be unscrewed and the spray arms pulled downwards to remove them.

Metal knurled nuts have a left-hand thread.

Ceramic knurled nuts have a right-hand thread.

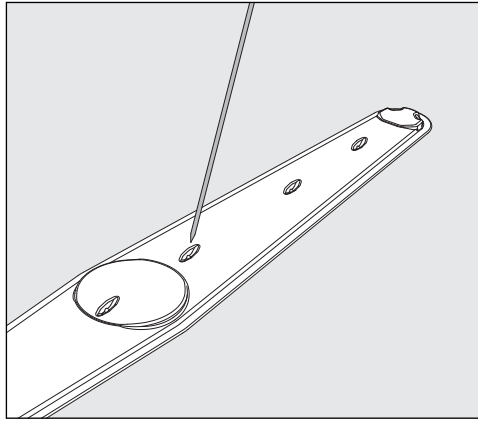

- Use a pointed object to push food particles into the spray arm.
- Rinse the spray arm thoroughly under running water.

⚠ Do not allow any magnetic objects or wash items stick to the magnets on the spray arms.
Remove all metallic objects from the magnets.

- Check the spray arm bearings for visible signs of wear.

Visible wear on the bearings can adversely affect the long-term functioning of the spray arms.
In this case, contact Miele Service.

- Replace the spray arms after cleaning.
- Make sure the spray arms can rotate easily after they have been fitted.

The spray arms and baskets each have a number e.g. 03, which is also embossed on the water supply pipes near the bayonet fittings. When refitting, ensure that the numbers on the spray arms correspond with the numbers on the water supply pipes.

Cleaning the machine

⚠ Never clean the machine or near vicinity with a water hose or a pressure washer.

⚠ Do not use cleaning agents containing ammonia or thinners on stainless steel surfaces!

These agents can damage the surface material.

Cleaning the control panel

Do not use any abrasive materials or general-purpose cleaners to clean the control panel.

These can cause considerable damage to the glass and plastic surfaces and to the onset control buttons.

- Clean the control panel with a damp cloth and a little washing-up liquid or with a non-abrasive stainless steel cleaner.
- Proprietary glass or plastic cleaning agents can also be used to clean the display.
- For surface disinfection use a listed agent recommended by the manufacturer.

Cleaning the door and the door seal

- Wipe the door seal regularly with a damp cloth to remove soiling. Have damaged or leaking door seals replaced by Miele Service.
- Remove any soiling from the door sides and hinges.
- Regularly clean the groove in the plinth panel under the door with a damp cloth.

Cleaning the wash cabinet

The wash cabinet is largely self-cleaning, however if deposits should start to build up, contact Miele Service.

Cleaning the door front

- To clean the stainless steel front, use a damp cloth with a solution of washing-up liquid and hot water, or with a non-abrasive cleaning agent for use on stainless steel.

Preventing re-soiling

- To help prevent re-soiling of stainless steel surfaces (fingerprints, etc.), a suitable stainless steel conditioner can be used after cleaning.

Checking mobile units, baskets, modules and inserts

Mobile units, baskets, modules and inserts should be checked daily to make sure they are functioning correctly. The machine is supplied with a check list.

Check the following points:

- Are the mobile unit or basket rollers in good condition, and are they securely attached to their mobile units or baskets?
- Are the water connectors present and undamaged?
- Are height-adjustable water connectors adjusted to the correct height and securely fixed?
- Are all injector nozzles, irrigation sleeves and hose adaptors securely attached to mobile units/inserts?
- Are all injector nozzles, sleeves, and hose adapters clear so that wash fluid can flow through unhindered?
- Are all caps and fasteners securely attached to the irrigation sleeves?
- Are end caps present and securely located for all modules and injector manifolds?
- Are the locking caps in the water connectors of mobile units and baskets working properly?

and where applicable:

- Make sure that the spray arms rotate freely.
- Make sure the spray arm jets are free of any blockages. See "Cleaning the spray arms".
- Make sure that the magnets integrated into the spray arms have no metallic objects sticking to them.
- Check whether the tubular filters need to be cleaned or filter plates, e.g. in an E 478/1 need to be replaced.

Maintenance of mobile units, baskets, modules and inserts

The machine should be serviced **every 1000 hours of operation, or at least once a year** by Miele Service.



The following guide may help you to find the reason for a fault, and to correct it. You should, however, note the following:

 Repairs may only be carried out by Miele Service.
Repairs and other work by unqualified persons could be dangerous for the user.

To avoid unnecessary service call-outs, check that the fault has not been caused by incorrect operation when an error message first appears.

For all fault messages:
If the cause is not remedied and the machine is switched off, when it is switched back on again the fault message must be acknowledged with the code. The machine will be locked for further use until this is done.

Technical faults and messages

Problem	Cause and remedy
The display is dark and all LEDs are out.	The machine is not switched on. ■ Switch the machine on using the  button.
	A fuse is defective or has tripped ■ Minimum fuse rating - see data plate. ■ Reset the trip switch. ■ If the mains fuse trips again, call Miele Service.
	The machine is not plugged in, or connected to the mains. ■ Plug the machine in and connect it to the mains supply.
The machine has switched itself off.	This is not a fault. The Auto-Off function switches the machine off automatically after a pre-set duration to save energy. ■ Switch the machine on using the  button.
Next service due on:	This is not a fault. Miele Service has recommended a date for the next service visit. ■ Please contact the Miele Service Department to arrange a service visit.

Problem solving guide

Dispensing / dispensing systems

 Caution when handling chemical agents.

For all chemical agents, the chemical agent manufacturer's safety instructions as given on their safety data sheets must be observed.

Problem	Cause and remedy
The dispenser for powder cleaning agent contains residual agent at the end of the programme.	The dispenser was still damp when cleaning agent was added. <ul style="list-style-type: none"> ■ Make sure the dispenser is dry before adding powder cleaning agent.
	The dispenser flap was blocked by items in the cabinet. <ul style="list-style-type: none"> ■ Rearrange the load so that the flap can open.
The dispenser flap will not close.	Residual cleaning agent is blocking the catch. <ul style="list-style-type: none"> ■ Remove the cleaning agent.
DOS Refill	During a programme sequence a low level of liquid chemical agent in a container has been identified. <ul style="list-style-type: none"> ■ Refill the container before the start of the next programme or exchange it for a full container.
DOS Vent at end of programme	During a programme an uneven flow rate of a liquid chemical agent has been identified. There may be air in the dispensing system. <ul style="list-style-type: none"> ■ Allow the programme to continue to the end. ■ Vent the dispensing system at the end of the programme.
Programme could not be started. Vent DOS	A programme cannot be started because ... <ul style="list-style-type: none"> ... there is air in the dispensing system. ... the dispensing system has been sucked completely dry. ■ Check the level in the supply container and refill or replace it with a full container as necessary. ■ Vent the dispensing system.
Dispensing system DOS venting	This is not a fault. The dispensing system will now be automatically vented. Wait until the venting process is finished.
Venting DOS cancelled. Venting must be repeated	Venting of the dispensing system was cancelled because an insufficient flow rate has been identified. A dispensing hose may be kinked or the siphon blocked. <ul style="list-style-type: none"> ■ Check the dispensing hose for kinks and leaks. Position it so that it cannot become kinked. ■ Check the suction aperture of the siphon for blockages and remove these as necessary. ■ Start the venting process again. Contact Miele Service if there are leaks in the dispensing hose or a fault with the siphon.

Problem	Cause and remedy
Check container/lance DOS	<p>Little or no flow has been identified.</p> <ul style="list-style-type: none"> ■ Check the level in the supply container and refill or replace it with a full container as necessary. ■ Check the suction aperture of the siphon for deposits. ■ Vent the dispensing system.
	<p>The dispensing hose is blocked.</p> <ul style="list-style-type: none"> ■ Remove any kinks from the dispensing hose. Position it so that it cannot become kinked. ■ Check the dispensing hose for leaks. ■ Vent the dispensing system. <p>Contact Miele Service if there are leaks in the dispensing hose or a fault with the siphon.</p>

Highly viscous (thick) chemical agents can affect the dispenser monitoring and lead to inaccurate data. In this instance please contact Miele Service for advice.

The viscosity does not affect dosage concentration levels.

Problem solving guide



Insufficient salt / Water softener

Problem	Cause and remedy
Refill salt	Salt is running low in the water softener. ■ Refill the reactivation salt before starting the next programme.
Machine locking out Insufficient salt	Salt in the water softener is completely depleted and reactivation is no longer possible. The machine is locked for further use. ■ Refill the reactivation salt.
Salt container empty, Programme locked out	The water softener cannot reactivate because there is insufficient salt. The machine is locked for further use. ■ Refill the reactivation salt. The lock is lifted a couple of seconds after refilling the salt reservoir. Reactivation will occur automatically during the next programme.
Salt container lid not correctly closed	The salt container is not closed properly. ■ Close the container properly.
	Salt residues are preventing it from closing. ■ Remove the residues from the refilling funnel, the lid and the seal. ■ Close the container properly.

Cancel with fault code

If a programme is cancelled and a fault code appears, e. g. Fault XXX (whereby XXX represents a number), there could be a serious technical fault.

In the event of a programme being cancelled and a fault number being shown:

- Switch the machine off using the  button.
- Wait approximately 10 seconds before switching the machine on again with the  button.
- Acknowledge the fault code by entering your lock code.
- Start the previously selected programme again.

If the same message appears again:

- Make a note of the fault message
- Switch the machine off using the  button.
- Contact the Miele Service Department.

Please also read the notes regarding the following fault numbers:

Problem	Cause and remedy
Fault 403-405	<p>A programme has been cancelled because water intake by the machine was insufficient or severely restricted.</p> <ul style="list-style-type: none"> ■ Open the stopcocks fully. ■ Follow the further information given in the Check water inlet message.
Fault 406-408	<p>A programme was cancelled because the water intake volume is insufficient.</p> <ul style="list-style-type: none"> ■ Check whether the stopcocks are fully opened. ■ Refer to the information regarding minimum flow pressure in "Plumbing" and "Technical data". ■ Check the filter in the water inlet. ■ Contact Miele Service for advice.
Fault 412-414	<p>A programme was cancelled because the water intake volume is too high.</p> <ul style="list-style-type: none"> ■ Refer to the information regarding recommended maximum flow pressure and maximum permissible static water pressure in "Plumbing" and "Technical data". ■ Contact Miele Service for advice.
Fault 440	<p>The float switch in the base of the machine has not been activated. The switch might be blocked.</p> <ul style="list-style-type: none"> ■ Remove the filter combination. ■ Check the float switch to make sure it moves freely. The float switch is located in the base of the machine behind the spray arm.

Problem solving guide

Problem	Cause and remedy
Fault 518	<p>No flow was detected when dispensing from an external supply container.</p> <div data-bbox="555 322 1407 501" style="border: 1px solid black; padding: 5px;"><p> Caution when handling chemical agents. For all chemical agents, the chemical agent manufacturer's safety instructions as given on their safety data sheets must be observed.</p></div> <ul style="list-style-type: none">■ Check the level of the container and refill or replace it as necessary.■ Check the suction apertures of the siphons and remove any deposits.■ Check the hose connections on the siphons, the machine and any DOS modules.■ Remove any kinks from the dispensing hoses and check the hoses for leaks. Position the dispensing hoses so that they cannot kink.■ Vent the dispensing system <p>If you identify any leaks in the dispensing hoses or defects on the siphons contact Miele Service.</p>
Fault 526	<p>Minimum flow pressure was not reached because one or more free water connectors in the back panel of the wash cabinet is not properly secured.</p> <ul style="list-style-type: none">■ Check the washers in the water connectors in the back panel of the wash cabinet and remove any blockages.

Process-related faults and messages

Problem	Cause and remedy
Wrong code entered	<p>The code entered is not the same as the code saved.</p> <ul style="list-style-type: none"> ■ Enter the code again. ■ Report the loss of the code to Miele Service.
Programme cancelled	<p>This is not a fault. A programme which was running was cancelled by the user.</p> <div style="border: 1px solid gray; padding: 5px; margin-top: 10px;"> <p> The wash cabinet interior can be very hot. When the door is opened, hot steam and chemical agents can escape. Protective measures for personal safety must be observed.</p> </div>
Programme continued	<p>This is not a fault. The process of cancelling a programme was not completed. The programme which was running continued without interruption.</p>
All settings reset	<p>This is not a fault. A user has restored factory default settings.</p> <ul style="list-style-type: none"> ■ Confirm the message with <i>OK</i>.
All programme settings reset	<p>This is not a fault. A user has restored the factory default setting for the programme.</p> <ul style="list-style-type: none"> ■ Confirm the message with <i>OK</i>.

Problem solving guide

Unsatisfactory cleaning and corrosion.

Problem	Cause and remedy
There are white deposits on the wash load.	The water softener is set too low. ■ Set the water softener to the correct water hardness.
	There is no salt in the salt reservoir. ■ Refill the reactivation salt.
	The quality of the water for the final rinse was insufficient. ■ Use water with a low conductance value. ■ If the machine is connected to a water softening cartridge, check it and replace as necessary.
	The water from the AD water connection is not sufficiently softened. ■ Check the pre-selected water softening units. If necessary, replace the water softening cartridge with a new one.
The cleaning result is unsatisfactory.	Mobile units, baskets, modules and inserts were not suitable for the load. ■ Select mobile units, baskets, modules and inserts which are suitable for the task.
	Mobile units, baskets, modules and inserts were incorrectly loaded or overloaded. ■ Arrange the wash load correctly according to the information in the operating instructions. ■ Avoid overloading the mobile units, baskets, modules and inserts.
	The programme was not suitable for the soiling. ■ Select a suitable programme. or ■ Adjust the parameters to suit the task.
	A spray arm is blocked. ■ Ensure the spray arms are not obstructed when arranging the wash load.
	Injector nozzles on the mobile units, baskets, modules or inserts are blocked. ■ Check the nozzles and clean them as necessary.
	The filters in the wash cabinet are dirty. ■ Check the filters and clean them if necessary.
	Mobile units, baskets or modules were not correctly docked to the water connection. ■ Check the connection.

Problem	Cause and remedy
Items made of glass are showing signs of corrosion.	The items are not suitable for machine reprocessing. ■ Only use items which are declared by their manufacturer as suitable for machine reprocessing.
	Neutralisation has not taken place during the programme. – Dispense using the DOS 2 reservoir ☼ in the door: ■ Refill the reservoir with neutralising agent. – Dispense via and external container: ■ Check the level in the supply container and vent the dispensing system if necessary.
	The wash temperature was too high. ■ Select a different programme. or ■ Reduce the wash temperature.
	Cleaning agents used were too alkaline. ■ Use a milder cleaning agent. or ■ Reduce the concentration of the cleaning agent.
Stainless steel items are showing signs of corrosion.	The stainless steel is of insufficient quality for machine reprocessing. ■ Only use stainless steel items made of high quality stainless steel and follow the instructions of the manufacturer regarding machine reprocessing.
	The chloride content in the water is too high. ■ Have a water analysis check carried out. Connection to an external water processing unit and the use of demineralised water may be necessary.
	Neutralisation has not taken place during the programme. – Dispense using the DOS 2 reservoir ☼ in the door: ■ Refill the reservoir with neutralising agent. – Dispense via and external container: ■ Check the level in the supply container and vent the dispensing system if necessary.
	Rust or superficial rust has built up in the wash cabinet, e.g. due to an excessively high iron content in the water or rust on other wash load items. ■ Check the installation. ■ Discard any rusty items.

Problem solving guide

Water inlet and drainage

Problem	Cause and remedy
Check water inlet	One or more stopcocks are closed. ■ Open the stopcocks.
	There was insufficient water in the machine. ■ Clean the water intake filters. ■ Open the stopcocks fully.
	Flow pressure at the water connection is less than 0.3 bar (30 kPa). ■ Contact a suitably qualified plumber.
Check drainage	<p>The water drains away slowly or cannot drain away because ...</p> <ul style="list-style-type: none">... the drain hose is blocked. ■ Remove any kinks or large loops in the drain hose. ■ Start the programme again.- the filters in the wash cabinet are blocked. ■ Clean the filters in the wash cabinet. Protective measures for personal safety must be observed. ■ Start the programme again.- the drain pump or non-return valve may be blocked. ■ Clean the access to drain pumps and the non-return valve. Protective measures for personal safety must be observed. ■ Start the programme again.- the drainage system cannot take sufficient water. ■ Refer to the information in "Plumbing". ■ Contact a suitably qualified plumber.

Noises

Problem	Cause and remedy
Knocking noise in the wash cabinet.	<p>One or more spray arms are knocking against the wash load.</p> <ul style="list-style-type: none"> ■ Cancel the programme. To do this follow the instructions in "Cancelling a programme". ■ Arrange the wash load so it cannot obstruct the spray arms. ■ Make sure the spray arms can rotate freely. ■ Start the programme again.
Rattling noise in the wash cabinet.	<p>Items are insecure in the wash cabinet.</p> <ul style="list-style-type: none"> ■ Cancel the programme. To do this follow the instructions in "Cancelling a programme". ■ Rearrange the load so that items are secure. ■ Start the programme again.
Knocking noise in the water pipes.	<p>This may be caused by the on-site installation or the cross-section of the piping. It has no influence on the function of the machine.</p> <ul style="list-style-type: none"> ■ Contact a suitably qualified plumber.

Cleaning the drain pump and non-return valve

If water has not pumped away at the end of a programme there may be a foreign object in the drain pump or blocking the non-return valve.

- Take the filter combination out of the wash cabinet (see Maintenance / Cleaning the filters in the wash cabinet").

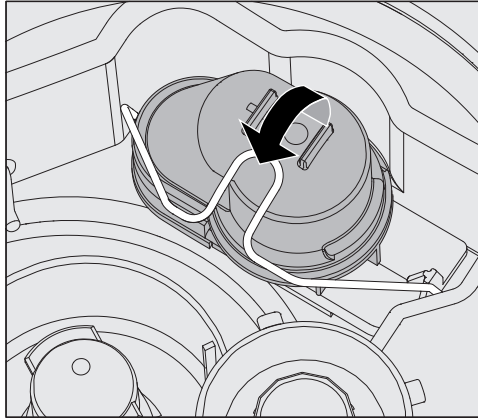

- Lift the locking clamp.
- Lift out the non-return valve and rinse well under running water.
- Make sure that the vent on the external part of the non-return valve is not blocked. (This vent is only visible when the non-return valve has been taken out). If it is blocked, use a pointed object to release the blockage.

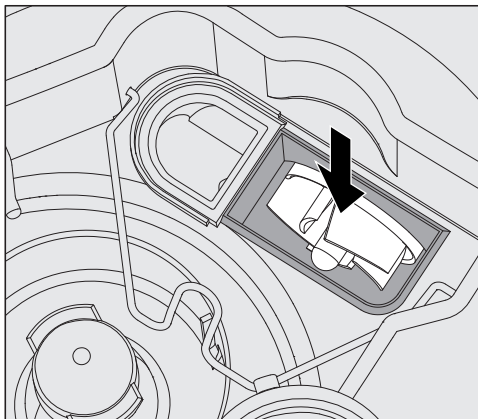

The drain pump impeller is situated under the non-return valve (see arrow).

- Check the impeller for blockages and remove them if necessary.
- Carefully replace the non-return valve and secure it with the clamp.

Clean the water intake filters

Filters are incorporated into the water inlet connection on the hose to protect the water inlet valve. If these filters get dirty they must be cleaned as otherwise too little water will flow into the wash cabinet.

⚠ The plastic housing on the water inlet valve contains an electrical component. It must not be dipped in water.

Cleaning the filters

- Disconnect the machine from the mains (switch the machine off, unplug it or disconnect or disable the fuse).
- Close the stopcock.
- Unscrew the inlet hose.

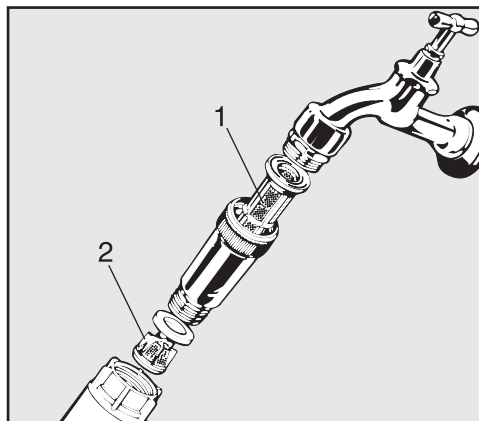

- Carefully pull the large surface area filter 1 out.
- Carefully remove the seal from the threaded union.
- Withdraw fine filter 2 using pointed pliers.
- Clean the filters or replace them with new ones if necessary.
- Replace the filters and seals, making sure they are sitting correctly.
- Reconnect the hose to the stopcock, making sure the union goes on straight and not cross-threaded.
- Turn on the stopcock gradually to test for leaks. If there is a leak, the inlet hose might not be on securely, or it may have been screwed on at an angle. Unscrew and reconnect the water inlet hose correctly before tightening it.

IMPORTANT

Australia and New Zealand

For Australia and New Zealand a non-return valve is required between the tap and filter.

Contacting Miele Service

 Repairs should only be carried out by a suitably qualified and trained Miele technician in accordance with local and national safety regulations. Unauthorised or incorrect repairs could cause personal injury or damage the machine.

To avoid unnecessary service call-outs, check that the fault has not been caused by incorrect operation when an error message first appears. Please refer to the information in "Problem solving guide".

If, having followed the advice in the operating instructions, you are still unable to resolve a problem please call the Miele Service Department (see the end of this booklet for contact details).



Contact details can be found at the end of this manual.

When contacting the Service Department, please quote the model type and number of your machine. These are shown on the data plates one on the side of the door and another on the back of the appliance.

Please tell Miele Service the fault message or code shown in the display.

Software version

When contacting the Service department you may need the version number of individual components of control software. These can be called up as follows:

- Open the Further settings menu by switching the machine off with the  button and then switch it on again with the  button whilst keeping the  button held in.
- Open the menu as follows:
 - ▶ Further settings
 - ▶ Software version



The software units are listed in the display. XXXXX stands for the relevant version number:

- EB Id: XXXXX
Software version of the control and display units in the control panel.
- EGL Id: XXXXX
Software version of the control board
- EZL Id: XXXXX
Software version of the relay board
- EFU Id: XXXXX
Software version of the frequency converter.

You cannot change any settings in this menu.

Software updates and upgrades may only be undertaken by Miele Service.

- Exit the menu with the *OK* or  buttons.

Installation and levelling

Please refer to the installation diagram provided.

⚠ In order to reduce the risk of water damage, the area around the machine should be limited to furniture and fittings that are designed for use in commercial environments.

The machine must be stable and horizontal.

Any unevenness in the floor level and height of the machine can be compensated for by adjusting the four feet. The feet can be screwed out to a maximum of 6 cm.

The machine is suitable for the following types of installation:

– Free-standing.

– Slot-in:

The machine can be installed beside other appliances or furniture or in a suitable niche. The niche must be at least 60 cm wide and 60 cm deep.

– Built-under:

The machine can be built under a continuous worktop or the draining board of a sink. The space provided must be at least 60 cm wide, 60 deep and 82 cm high.

Building under a continuous worktop

Removing the lid

To build the machine under a continuous worktop the lid must be removed as follows:

- Unscrew both securing screws from the lid at the back of the machine.
- Open the door.

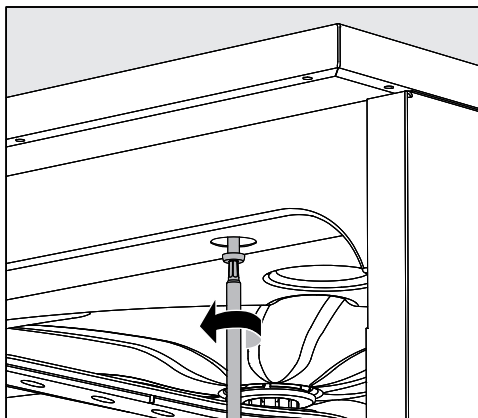

- Unscrew the left and right fixing screws.
- Lift the lid off.

Protective foil / worktop protector

The protective foil supplied protects the worktop from damage caused by steam when the door is opened. It should be positioned underneath the worktop above the machine door.

Securing to the worktop

To improve stability the machine must be secured to the worktop after it has been aligned.

- Open the door.

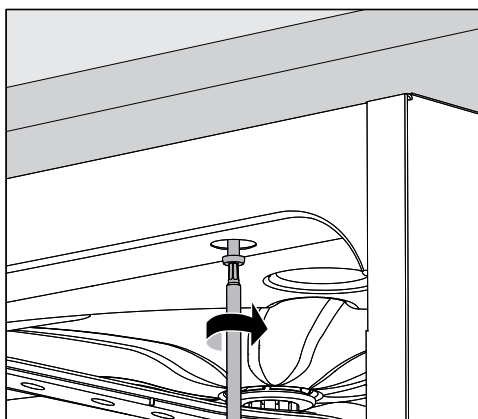

- Screw the machine to the continuous worktop through the holes in the front trim on the left and right.

Please contact Miele to secure it at the sides to adjacent cabinetry.

Installation

Venting the circulation pump.

 The gaps between a built-in machine and adjacent cabinetry must not be filled with silicone sealant as this could compromise the ventilation to the circulation pump.

Electromagnetic compatibility

This machine has been tested for electromagnetic compatibility (EMC) in accordance with EN 61326-1 and is suitable for operation in commercial environments, such as laboratories and other similar environments which are connected to the mains power supply.

The machine's HF emissions are very low and are therefore unlikely to interfere with other electronic appliances in the vicinity.

Flooring in the installation area must be wood, concrete or tiled. Synthetic flooring must be able withstand a relative humidity level of 30 % to minimise the risk of electrostatic discharges.

The quality of the power supply should comply with that found in a typical commercial or hospital environment and should deviate from the nominal voltage by a maximum of +/- 10 %.

⚠ All electrical work must be carried out by a suitably qualified and competent person in accordance with local and national safety regulations.

- In the U.K. it must comply with BS 7671.
- We recommend connecting the machine to the power supply via a suitable IP 44 plug and socket which must be easily accessible for servicing and maintenance work after the machine has been installed. An electrical safety test must be carried out after installation and after any service work.
- For hard-wired machines, connection should be made via a suitable mains switch with all-pole isolation which when in the off position ensures a 3 mm gap between all open contacts.
- Equipotential bonding should be carried out if required.
- For technical data see data plate or wiring diagram supplied.
- For extra safety and protection we recommend connecting the machine by a 30 mA residual current device (RCD).
- If replacing the mains cable, use only original Miele replacement parts or a suitable cable with core cable ends.

Further notes on electrical connection are given on the Installation diagram supplied with the machine.

The machine must only be operated with the voltage, frequency and fusing shown on the **data plate**.

Depending on country this machine **can be converted to a different type of power supply** in accordance with the conversion diagram and wiring diagram supplied.

A **data plate** can be found on the inside of the door and another on the back of the machine.

The wiring diagram is supplied with the machine.

WARNING

THIS APPLIANCE MUST BE EARTHED

Equipotential bonding connection

There is a screw connection point marked ∇ at the back of the machine, to which additional equipotential bonding can be connected if required.

Connection to the water supply

 Water from the wash cabinet must not be consumed.

- The machine must be connected to the water supply in strict accordance with current local and national water authority regulations.
- The water used must at least comply with European regulations for drinking water quality. If the water supply has a high iron content there is a danger of corrosion occurring on items being cleaned in the machine, as well as the machine itself. If the chloride content of the water exceeds 100 mg/l the risk of corrosion to items being cleaned in the machine will be further increased.
- UK, Australia and New Zealand only: To comply with water regulation requirements, this machine must be connected to the potable water supply via the check valve supplied with the machine.
- This machine is supplied as standard for connection to cold water (blue coded hose) **or** hot water up to max. 65 °C (red coded hose). Connect the inlet hose to the cold or hot water stopcock as required.
- The **Minimum flow pressure** for a cold or hot water connection is 40 kPa pressure, and for AD water connection is 30 kPa pressure.
- **Recommended flow pressure** for cold and hot water connections is ≥ 200 kPa pressure and for AD water connection ≥ 200 kPa pressure, to avoid excessively long water intake times.
- The **maximum permissible static water pressure** is 1000 kPa pressure.
- If the water pressure does not fall into the stated range contact Miele Service for advice.
- More information on AD water connection can be found at the end of this section.
- A stopcock valve with a $\frac{3}{4}$ " threaded union must be provided on site. It should be easily accessible so that the water supply can be turned off when the machine is not in use.
- The inlet hose is approx. 1.7 m long terminating in a $\frac{3}{4}$ " female thread. On no account may the inlet filter be removed.

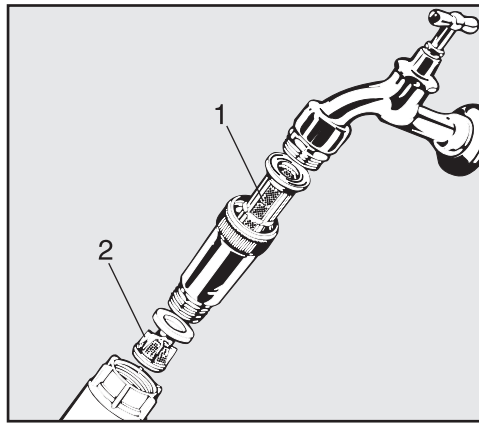

- Install the filter (supplied in accessory pack) between the stopcock valve and the inlet hose. The filter for AD water is made of chromium-nickel steel and can be recognised by its dull surface.

IMPORTANT
Australia and New Zealand

For Australia and New Zealand a non-return valve is required between the tap and filter.

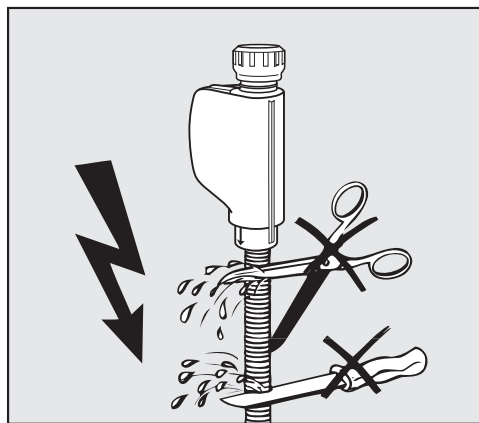

⚠ Do **NOT** shorten or otherwise damage the inlet hoses (see diagram).

See installation diagram supplied.

AD water connection for 30 - 1000 kPa pressure - pressure-resistant (optional)

This machine can be optionally supplied for a pressurised system operating between 30 - 1000 kPa. If the water pressure is below 200 kPa the water intake duration will be automatically increased.

- The pressure tested hose for AD water, coded green, has a $\frac{3}{4}$ inch threaded union for connection to the onsite stopcock for AD water.

⚠ If the machine is not going to be connected to AD water, the AD water connection has to be deactivated by a Miele Service technician. The inlet hose remains in position at the back of the machine.

Plumbing

AD water connection for 8.5 - 60 kPa - without pressure (optional)

The machine has to be converted for connection to 8.5 - 60 kPa pressure unless ordered as such ex-works. Installation of the pump must only be carried out by Miele Service.

With a pressureless AD water connection, the drainage point must be at least as high as the top of the machine. See installation instructions.

IMPORTANT

Australia and New Zealand.

This appliance must be installed according to AS/NZS 3500.1. This appliance has been supplied with a separate backflow prevention device.

This machine must be connected to the potable water supply via the non-return valve (check valve) supplied with the machine.

Before making plumbing connections, ensure the appliance is disconnected from the mains power supply (switch off or unplug the power).

- Turn off the mains water tap.
- Place the seals on both sides of the non-return valve.
- Connect the female end of the non-return valve to the mains water tap (3/4" thread).
- Connect the filter to the male end of the non-return valve (3/4" thread).
- Connect the inlet hose to the filter.

Ensure that all connections are screwed into position correctly. The connection point is subject to mains water pressure. Turn on the tap slowly and check for leaks. Correct the position of the seal and union if necessary.

Connecting the drain hose

- A non-return valve is incorporated into the drain system in the machine to prevent drainage water flowing back into the machine via the drain hose.
- The machine drainage hose should be connected to a **separate** drain for the machine only. If no separate drain is available, we recommend connecting it to a dual-chamber siphon.
- The on-site connection point, **measured from the lower edge of the machine**, should be positioned at a height between 0.3 m and 1 m. If it is lower than 0.3 m, the drain hose must be laid in a coil at a height of at least 0.3 m.
- The drainage system must be able to accommodate a minimum drainage flow of 16 l/min.
- The drainage hose is approx. 1.4 m long and flexible with an internal diameter of 22 mm. Hose clips for the connection are supplied.
- The drain hose must not be shortened.
- The drain hose can be extended using a connection piece to attach a further length of hose. The drainage length must not be longer than 4 m, and the delivery head must not exceed 4 m.

See installation diagram supplied.

Programme chart

Programme	When to use
Free memory	Programmable programme for special applications; programming by arrangement with Miele Service.
Short	For removing contamination that is easily soluble in water. Not suitable for denatured or acid-soluble residues such as proteins, metal salts and amines. For low levels of soiling and wash results.
Medium	For removing contamination that is easily soluble in water. Not suitable for denatured or acid-soluble residues such as proteins, metal salts and amines. For low levels of soiling and for normal wash results.
Long	For removing organic residues (e.g. proteins, oils and fats) and some inorganic residues. For low to medium levels of soiling and normal wash results.
Demineralised rinse	Rinse with fully demineralised water (DI water).
Rinsing	For flushing out saline solution (see "Water softener / Adding salt"), rinsing heavily soiled loads, e.g for pre-rinsing soiling, residual disinfecting agent, or to prevent items drying out and to prevent incrustation before running a full load.
Drain	For draining suds solution e.g. after a programme cancellation (see "Water softener / Cancelling a programme").

Programme chart

Programme sequence										
Pre-wash			Main wash		Interim rinse				Final rinse	
1	2	3	1	2	1	2 *	3	4	1	2
			CW 60°C DOS 1 3 Min				CW DOS 2 2 Min			AD 70°C 1 Min
			CW 65°C DOS 1 3 Min		CW DOS 2 2 Min	CW 1 Min				AD 70°C 1 Min
CW 1 Min			CW 70°C DOS 1 3 Min		CW DOS 2 2 Min	CW 1 Min				AD 70°C 1 Min
					AD					
					CW					

CW = cold water

AD = aqua destillata, fully demineralised water (VE), demineralised water

Min = Holding time in minutes

* = Optional programme block

DOS 1 = Cleaning agent

DOS 2 = Neutralising agent **or** Rinsing agent agent (door dispenser)

Programme chart

Programme selection and suitable accessories

Programme		Short	Medium	Long	Amount of water	Lower basket		Upper basket	
						Carrier for various inserts	2 injector modules	Carrier with spray arm for various inserts	2 injector modules
		OK	OK	OK		X			
		OK	OK	OK		X		X	
		OK	OK	OK	+ 1.5 l				
		OK	OK	OK		X		X	
		not permitted	not permitted	not permitted				X	X

Technical data

Height with machine lid Height without machine lid	83.5 cm 82 cm
Width	60 cm
Depth Depth with door open	60 cm 120 cm
Wash cavity dimensions height / width / depth	52.2 / 53.6 / 51.6 cm
Weight (net)	72 kg
Max. load capacity of open door	37 kg
Voltage, connected load, fuse rating	See data plate
Mains cable	Approx. 1.8 m
Water intake temperature: Cold water / Hot water AD water	max. 65 °C max. 65 °C
Static water pressure	Max. 1000 kPa pressure
Minimum water intake flow pressure: Cold water / Hot water AD water	40 kPa pressure 30 kPa pressure
Recommended water intake flow pressure: Cold water / hot water AD water	≥ 200 kPa pressure ≥ 200 kPa pressure
AD water connection without pressure (optional)	8.5 - 60 kPa
Delivery head	min. 0.3 m, max. 1 m
Drainage length	max. 4 m
Ambient temperature	5 °C to 40 °C
Relative humidity maximum linear decreasing to	80 % for temperatures up to 31 °C 50 % for temperatures up to 40 °C
Protection category (according to IEC 60529)	IP21
Soiling level (according to IEC/EN 61010-1)	2
Overvoltage category (according to IEC 60664)	II
Noise level in dB (A), sound pressure LpA during cleaning and drying phases	< 70
Test certificates awarded	EMC, VDE, radio and television suppressed
CE mark	2006/42/EC Machine guidelines
Manufacturer's address	Miele & Cie. KG, Carl-Miele-Straße 29, 33332 Gütersloh, Germany

Caring for the environment

Disposal of the packing material

The packaging is designed to protect the machine against transportation damage. The packaging materials used are selected from materials which are environmentally friendly for disposal and should be recycled.

Recycling the packaging reduces the use of raw materials in the manufacturing process and also reduces the amount of waste in landfill sites.

Disposing of your old machine

Electrical and electronic machines often contain valuable materials. They also contain materials which, if handled or disposed of incorrectly, could be potentially hazardous to human health and to the environment. They are, however, essential for the correct functioning of your machine. Please do not therefore dispose of it with your household waste.

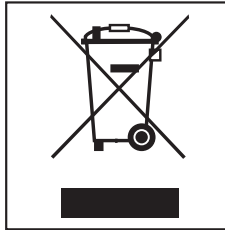

Please dispose of it at your local community waste collection / recycling centre or contact your dealer for advice.

Ensure that it presents no danger to children while being stored for disposal.

United Kingdom

Miele Co. Ltd.
Fairacres, Marcham Road
Abingdon, Oxon, OX14 1TW
Professional Sales, Tel: 0845 365 6608
E-mail: professional@miele.co.uk
Internet: www.miele-professional.co.uk

Australia

Miele Australia Pty. Ltd.
ACN 005 635 398
ABN 96 005 635 398
1 Gilbert Park Drive, Knoxfield, VIC 3180
Tel: 1300 731 411
Internet: www.miele-professional.com.au
E-mail: info@miele-professional.com.au

China

Miele (Shanghai) Trading Ltd.
1-3 Floor, No. 82 Shi Men Yi Road
Jing' an District
200040 Shanghai, PRC
Tel: +86 21 6157 3500, Fax: +86 21 6157 3511
E-mail: info@miele.cn, Internet: www.miele.cn

Miele (Hong Kong) Limited

41/F - 4101, Manhattan Place
23 Wang Tai Road
Kowloon Bay, Hong Kong
Tel: (852) 2610 1331, Fax: (852) 2610 1013
Email: mielehk@miele.com.hk

India

Miele India Pvt. Ltd.
Ground Floor, Copia Corporate Suites
Plot No. 9, Jasola
New Delhi - 110025
Tel: 011-46 900 000, Fax: 011-46 900 001
E-mail: customercare@miele.in, Internet: www.miele.in

Ireland

Miele Ireland Ltd.
2024 Bianconi Avenue
Citywest Business Campus, Dublin 24
Tel: (01) 461 07 10, Fax: (01) 461 07 97
E-Mail: info@miele.ie, Internet: www.miele.ie

Manufacturer: Miele & Cie. KG
Carl-Miele-Straße 29, 33332 Gütersloh, Germany

Miele

PROFESSIONAL

Malaysia

Miele Sdn Bhd
Suite 12-2, Level 12
Menara Sapura Kencana Petroleum
Solaris Dutamas No. 1, Jalan Dutamas 1
50480 Kuala Lumpur, Malaysia
Phone: +603-6209-0288
Fax: +603-6205-3768

New Zealand

Miele New Zealand Limited
IRD 98 463 631
Level 2, 10 College Hill
Freemans Bay, Auckland 1011, NZ
Tel: 0800 464 353
Internet: www.miele-professional.com.au
E-mail: info@miele-professional.com.au

Singapore

Miele Pte. Ltd.
163 Penang Road
04 - 03 Winsland House II
Singapore 238463
Tel: +65 6735 1191, Fax: +65 6735 1161
E-Mail: info@miele.com.sg
Internet: www.miele.sg

South Africa

Miele (Pty) Ltd
63 Peter Place, Bryanston 2194
P.O. Box 69434, Bryanston 2021
Tel: (011) 875 9000, Fax: (011) 875 9035
E-mail: info@miele.co.za
Internet: www.miele.co.za

United Arab Emirates

Miele Appliances Ltd.
P.O. Box 11 47 82
Gold & Diamond Park, Sheikh Zayed Road
Building 6 / Offices Nos. 6-214 to 6-220
Dubai
Tel: +971-4-341 84 44
Fax: +971-4-341 88 52
E-Mail: info@miele.ae, Internet: www.miele.ae