



5.5 cu.ft. Undercounter Refrigerator

TSX Series

Installation and Operation

328277H01 Rev. A April 2017

Visit us online to register your warranty
www.thermoscientific.com/labwarranty

thermoscientific

IMPORTANT Read this instruction manual. Failure to follow the instructions in this manual can result in damage to the unit, injury to operating personnel, and poor equipment performance.

CAUTION All internal adjustments and maintenance must be performed by qualified service personnel.

Material in this manual is for informational purposes only. The contents and the product it describes are subject to change without notice. Thermo Fisher Scientific makes no representations or warranties with respect to this manual. In no event shall Thermo be held liable for any damages, direct or incidental, arising from or related to the use of this manual.

© 2017 Thermo Fisher Scientific Inc. All rights reserved.

Table of Contents

Product Specifications	1
Models	1
General Specifications and Features	1
Physical Dimensions	2
Agency Approvals	2
Data Monitoring and Logging	2
Environmental Operating Conditions	2
Safety Precautions.....	3
Wiring Diagram	6
Unpacking the TSX Refrigerator	7
Inspecting for Damage	7
Unboxing and Locating	7
Identifying all Parts	7
Installation.....	8
Leveling	8
Intended Use	8
Providing Ventilation	8
Power On and Power Cord Guidelines	9
Uninterruptable Power Supply (UPS)	10
Operation.....	11
LED Indicator	11
Checking the Glycol Sample Bottle	11
Preprogrammed Settings	12
Preset alarms/alerts	12
Set Point Temperature	12
Loading Products for the First Time	13
Tips for Managing Door Openings	13
Automatic Defrost Cycles	13
Getting To Know Your Product.....	14
Product Exterior - Front	14
Touch Screen Display	14
Input / Output Dock.....	14
Ventilation.....	15
Door Lock	15
Product Exterior – Rear	17
Access Port.....	17
Evaporation Tray.....	17
Product Interior	17
Interior Components.....	18

Table of Contents

Adjustable Shelving	18
Navigating TSX 5.5 Cu.Ft. Refrigerator Controls.....	19
System Icons	19
System Prompts	19
System Alerts	20
System Alert Values	20
Reading the LCD (Temperature) Display	20
Login and Unlock Door	21
Login	21
Unlock/Lock Door.....	22
Access the Main Menu	22
Alarms	22
Data Log.....	23
Settings	26
Administrator Tools	29
Periodic Product Maintenance	31
Frequently Asked Questions	32
Troubleshooting	34
Product Warranty and Service.....	36

1 Product Specifications

1.1 Models

Model	Description
TSX505SA	TSX Under-Counter Solid door Refrigerator, NEMA 5-15P
TSX505GA	TSX Under-Counter Glass door Refrigerator, NEMA 5-15P
TSX505SD	TSX Under-Counter Solid door Refrigerator, NEMA 6-15P
TSX505GD	TSX Under-Counter Glass door Refrigerator, NEMA 6-15P
TSX505SV	TSX Under-Counter Solid door Refrigerator, EU plug
TSX505GV	TSX Under-Counter Glass door Refrigerator, EU plug
TSX505SC	TSX Under-Counter Solid door Refrigerator, CN plug
TSX505GC	TSX Under-Counter Glass door Refrigerator, CN plug
TSX505SW	TSX Under-Counter Solid door Refrigerator, UK 10 amp plug
TSX505GW	TSX Under-Counter Glass door Refrigerator, UK 10 amp plug

1.2 General Specifications and Features

Model Style	5.5 cu.ft. undercounter refrigerator
Materials	Durable painted steel exterior with easy-to-clean interior aluminum walls
Internal Chamber Capacity	5.5 cu.ft. / 156 liters
Chamber Temperature Uniformity	$\pm 1^{\circ}\text{C}$ / $\pm 1.8^{\circ}\text{F}$ from center air temperature
Cooling System	Refrigeration system with two 125W thermoelectric heat pumps
Refrigerant	R744, non-flammable, zero ozone depleting, low toxicity
Refrigerant charge quantity	Force Accept System: 17 g Max Cold Wall System: 30 g Max
Refrigerant Pressure rating	12410 kpa
Energy consumption	Solid door 2.7 kWh/24 hrs @ 4°C set point and 25°C ambient
Insulation	CFC-free insulation
Display	Full-color 4.5" LCD with LED backlighting
Power Cord	1.8 meter, NEMA hospital grade plug
Noise Level	35 dBA

Power Input	100-240VAC, 47 – 63 Hz
Amps	5 Amps

1.3 Physical Dimensions

Weight	125 lbs. / 56.8 Kg
Outer Dimensions	600 mm W x 661 mm D x 808 mm H 23.6” W x 26” D x 31.8” H
Internal Dimensions	496 mm W x 521 mm D x 585 mm H 19.5” W x 20.5 D x 23” H
ADA Height Compliant	Yes
Stability	Leveling feet

1.4 Agency Approvals

International Approval	CE, UL
NRTL Mark	cULus
CAN Recognition	YES
RoHS	YES
REACH	YES

1.5 Data Monitoring and Logging

Memory	512 kb Non-Volatile Memory
Access Ports	Pass-through port for additional monitoring probe USB port for exporting temperature monitoring data
Temperature Sensors	Interior Chamber Air (2) and Glycol (1)

1.6 Environmental Operating Conditions

Maximum ambient temperature	18°C – 32°C
Humidity requirements	Low humidity. Not for outdoor use
Warranty	2 years on all parts and labor, 7 years on thermoelectric heat pumps part

2 Safety Precautions

All electrical appliances present some risk of injury. Your TSX refrigerator is designed to meet safety standards.

Take care to carry and move your refrigerator with caution. Do not place it where it can fall, be dropped, or where the electrical connection can be submerged into water or other liquids.



Refer to Unpacking your TSX Refrigerator for details on handling and moving the unit.

There are no user-serviceable parts within the TSX 5.5 cu.ft. /156 L product.

Symbols used in this manual are described as follows:



Used to indicate an electrical shock hazard.



Used when advice is given to prevent malfunction or injury.



Used to prohibit flammable items.

Electrical Components



Do not remove the top cover or operate unit with top cover removed. Removal of the rear cover can result in electrical shock. Service only by a factory authorized service person.



Before installing, using or maintaining this product, be sure to read the manual and product warning labels carefully. Failure to follow these instructions may cause the product to malfunction, which could result in injury or damage.



CAUTION: For Class B - Unintentional Radiators:

This device complies with Part 15 of the FCC Rules. Operation is subject to the following two conditions: (1) this device may not cause harmful interference and (2) this device must accept any interference received, including interference that may cause undesired operation.



WARNING: Hazardous voltages are present: To reduce the risk of electric shock and danger to personal health, follow the instructions provided in this manual.



CAUTION: ICES-003 Class B Notice—Avis NMB-003, Class B

This Class B digital apparatus complies with Canadian ICES-003.



Note *This equipment has been tested and found to comply with the limits for a Class B digital device, pursuant to Part 15 of the FCC Rules. These limits are designed to provide reasonable protection against harmful interference in a residential installation. This equipment generates, uses and can radiate radio frequency energy and, if not installed and used in accordance with the instructions, may cause harmful interference to radio communications. However, there is no guarantee that interference will not occur in a particular installation.*

If this equipment does cause harmful interference to radio or television reception, which can be determined by turning the equipment off and on, the user is encouraged to try to correct the interference by one or more of the following measures:

- Reorient or relocate the receiving antenna
- Increase the separation between the equipment and receiver
- Connect the equipment into an outlet on a circuit different from that to which the receiver is connected

Consult the dealer or an experienced radio/TV technician for help.



WARNING: Hazardous voltages are present: To reduce the risk of electric shock DO NOT remove the rear cover on this product. There are no user serviceable parts inside. Please refer service to qualified personnel.



WARNING: In order satisfy the FCC RF exposure limit for transmitting devices, a separation distance of 20 cm should be maintained between the body and the TSX refrigerator while in operation.



CAUTION: This device complies with Industry Canada license-exempt RSS standard(s). Operation is subject to the following two conditions: (1) this device may not cause interference, and (2) this device must accept any interference, including interference that may cause undesired operation of the device.



WARNING: The antenna used for this transmitter must not be co-located in conjunction with any other antenna or transmitter.



CAUTION: Any modifications made to this device that are not approved by Thermo Scientific may void the authority granted to the user by the FCC to operate equipment.



CAUTION: Cells/batteries shall be tested and pass applicable regulations based on type and use such as:

- IEC62133 for secondary battery safety
- UN3090/UN3091 and UN3480/UN3481 for Lithium Battery transport regulations
- Transport regulations based on the following: International Air Transport Association (IATA), International Civil Aviation Organization (ICAO), International Maritime Dangerous Goods (IMDG) Code, Transport of Dangerous Goods (TDG).

3 Wiring Diagram

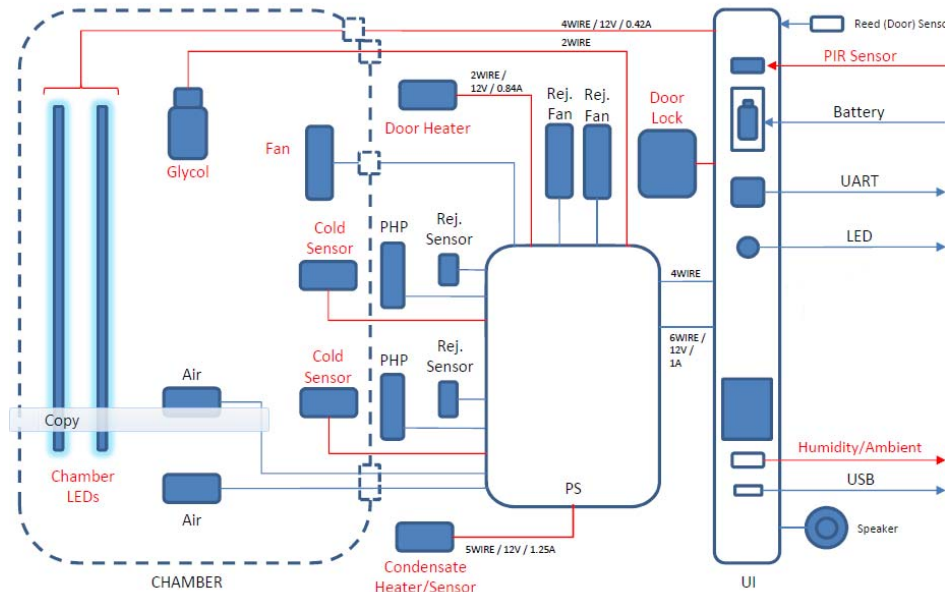

Figure 1. Wiring diagram for TSX 5.5 cu.ft. Undercounter Refrigerator

4 Unpacking the TSX Refrigerator

4.1 Inspecting for Damage

Please take a moment to inspect your new refrigerator for damages that may have occurred during shipping. For any damage done to the refrigerator, please contact the delivery carrier directly.



Do not call the TSX service line to report shipping damages. Call your carrier.

We have designed intelligent packaging to assist you in unpacking your TSX compact refrigerator. Your TSX product was built, inspected, tested, and packaged with extreme care. Follow the directions provided to unpack your new product safely and easily.

4.2 Unboxing and Locating

We recommend you move the box as close as possible to its final location before you begin to unpack. This unit is not provided with handles, therefore it is recommended that 2 people move and remove the refrigerator from the packaging by lifting at the base of the refrigerator. The packaged unit weighs nearly 140 pounds (63.6 Kg), so lift it with caution. Remove the lower packing strap and lift the top cover of the box to expose the refrigerator for removal and placement. To remove the bottom foam protectors, carefully tip the unit to one side and remove the opposite side foam piece (repeat for other side piece).

4.3 Identifying all Parts

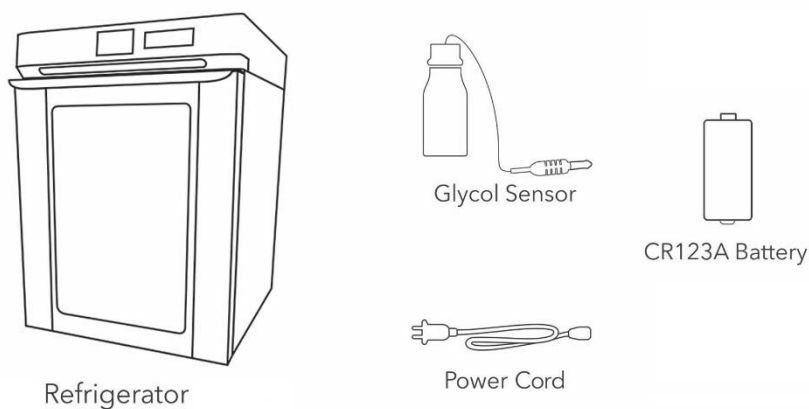

Figure 2. Parts of the Refrigerator

5 Installation

5.1 Leveling

Adjust the leveling feet located underneath the refrigerator by turning clockwise to extend the feet, counter clockwise to shorten them. It is important that the unit is level.

5.2 Intended Use

Do not locate or store your refrigerator outdoors. This model was designed for indoor use only and violation of this will void the terms of your warranty.

The refrigerators described in this manual are high performance units for professional use. These products are intended for use as cold storage in research use and as a general purpose laboratory refrigerator, storing samples or inventory at operating temperatures between 3°C and 7°C.

It is not considered a medical device and has therefore not been registered with a medical device regulatory body (e.g. FDA): that is, it has not been evaluated for the storage of samples for diagnostic use or for samples to be re-introduced into the body.

This unit is not intended for use in classified hazardous locations, nor to be used for the storage of flammable or corrosive inventory.

5.3 Providing Ventilation



Your TSX undercounter refrigerator is equipped with a ventilation area just above the door handle. Do not block or cover the venting area as this can impact the performance of the refrigerator.



The fans on your product will run at intervals of variable speeds and may turn off completely. They do not run constantly. If the fans run frequently, the product may require more space for ventilation. Please refer to the section on how to clean and troubleshoot the fan for more information.



WARNING: Fan has moving parts, product has uninsulated live parts and hot parts. Do not remove the top panel or attempt repairs. For repairs or operating issues call Customer Care at 866-984-3766 for guidance and instructions.

5.4 Power On and Power Cord Guidelines



1. Use only the power cord provided with your TSX undercounter refrigerator.
2. Plug the power cord into the receptacle on the upper rear of the refrigerator as indicated. Secure the strain relief to ensure the cord cannot accidentally pull out (as shown above).
3. Position the refrigerator where you intend to locate it, taking care to give it the recommended clearance and plug into a grounded three prong receptacle. This outlet must be within reach to disconnect power source.

Note *The electrical safety of this product may become impaired if the user chooses to disregard this power safety steps listed above.*



Be careful not to plug into a wall outlet controlled by a wall switch to avoid accidentally switching off the refrigerator. To function properly the refrigerator must continually receive power.



Caution, risk of electrical shock. If the cord or plug becomes damaged, replace with a cord and plug of the same type and rating.

5.5 Uninterruptable Power Supply (UPS)

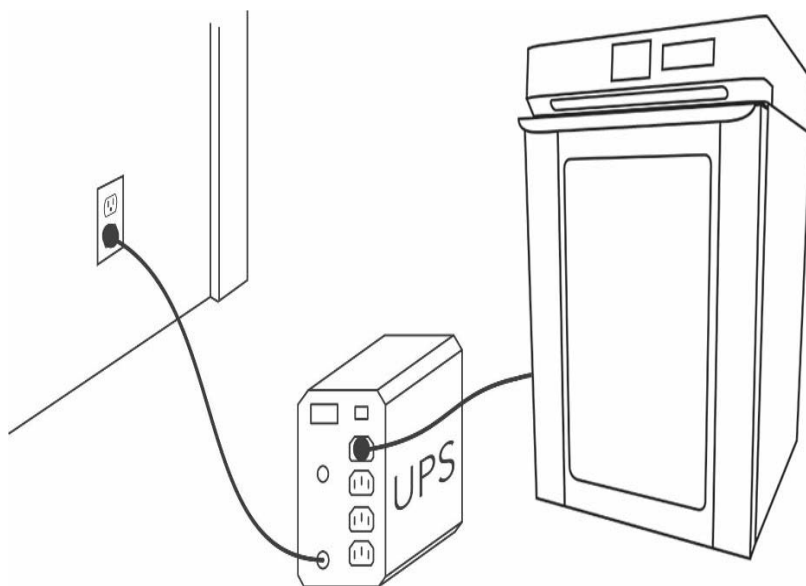

Your TSX refrigerator is compatible for use with a UPS battery backup. The primary role of any UPS is to provide short-term power when the input power source fails. If you use a UPS backup, take care to follow the directions and precautions accompanying that device.

6 Operation

6.1 LED Indicator

When you turn on your refrigerator, verify that the LED indicator is working. The LED indicator appears on the front control panel next to the upper corner of the display. The LED indicator illuminates green when the unit is on and running. It illuminates red if there is a data log concern such as:

- Low Battery
- Full Memory
- Data Logging Error



A power outage would result in a flashing red or green light every 15 seconds. Flashing green indicates continuous data logging. Flashing red indicates a data logging error. See the troubleshooting guide for ways to resolve the issue.

6.2 Checking the Glycol Sample Bottle



The glycol sample bottle is pre-installed inside your unit. The sample bottle allows you to monitor the internal temperature of items being stored in the refrigerator.

Verify the following:

1. The cord for the sample bottle is fully plugged into the back wall of the interior of your unit.
2. The sample bottle is securely mounted in the clip provided.
3. The level of the propylene glycol in the bottle is full.

In the event that the bottle has broken during shipping, contact our service department for a replacement bottle.

6.3 Preprogrammed Settings

Settings can be customized via the Settings and Alerts menus.

Temperature Display & Alarm – The display is preset to read the glycol sensor but can be changed to read the air sensor. Temperatures are detected and displayed in Celsius units to one tenth of a degree. For example, 4.0°C. Upper and lower alarm thresholds are driven by door the sensor selected for the display.

- Set Point Temperature – The unit preset/default is set at 5.0°C (39.2°F)
- Upper Threshold Alarm – The unit preset/default is set at 8.0°C (46.4°F)
- Lower Threshold Alarm – The unit preset/default is set at 2.0°C (35.6°F)

6.4 Preset alarms/alerts

The following alarms/alerts are factory preset:

Alarm	Factory Setting	Icon
Temperature Range Alarm	min 2 °C max 8 °C	
Door Ajar Alarm	1 minute	
No Power Alarm	> 10 seconds outage	
Battery Low Alarm	< 30% remaining	
Memory Full Alarm	< 30% remaining	

6.5 Set Point Temperature

When you first turn on the unit, the fan will run and the refrigerator will work to reach the default set point temperature. Once set point is reached, the fan speed will reduce to conserve energy. The unit will reach Air Temperature setting rapidly. Reaching Glycol set point temperature will take longer.

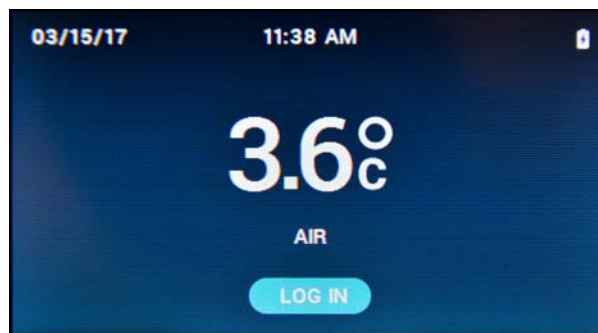

When the unit is first plugged in and powered, the Temperature Range Alarms are not enabled until the unit reaches its preset temperature range + an offset of

3°C. If the set point temperature is 4°C, then the alarms are enabled when the unit reaches 7°C.

6.6 Loading Products for the First Time

After you power on your refrigerator, monitor the temperature display on the control panel and do not load until the default set point is reached. There are three temperature monitors inside the refrigerator, the glycol sensor and two air sensors. When you load the refrigerator, always remember to provide some clearance around the air and glycol sensors and make sure the glycol sensor remains properly connected.

When loading products previously stored at room temperature, monitor the temperature display to prevent a compromise. We suggest you load room temperature samples in small increments to help maintain a stable temperature.



Don't load product until the preprogrammed set point is reached.



Always provide adequate clearance around both the air and glycol sensors.

6.7 Tips for Managing Door Openings

When a refrigerator door is opened, warmer ambient air enters and causes the interior temperature to fluctuate. To limit this effect, there are a few simple steps you can follow to reduce the number of times the door is opened as well as the duration it is left opened:

- List a detailed inventory of the refrigerator's contents on a chart posted outside the unit to reduce the time spent searching for items when the door is opened.
- Use clearly labeled bins to organize and quickly identify contents.
- Avoid storing beverages or any non-sample items (like food) in any unit used for sensitive inventory. Not only is this a health hazard, it also leads to more frequent opening of the door.

Note *TSX compact refrigerators have a visible and an audible open door alarm that sounds when a door has been open for more than 1 minute.*

6.8 Automatic Defrost Cycles

The TSX refrigerator will run a pre-programmed automatic defrost cycle every 24 hours. During the defrost cycle you will likely hear the fan turning off and on. In addition to the automatic defrost cycles, you can initiate a manual defrost cycle through the Settings menu.

7 Getting To Know Your Product

7.1 Product Exterior - Front



7.1.1 Touch Screen Display

The touch-screen display is located in the center of the upper console and is the single point-of-use for controlling the refrigerator. The display is 4.3” diagonal, landscape orientated and full-color TFT-LCD supporting 65K color.



7.1.2 Input / Output Dock

7.1.2.1 USB Port

A USB port is available to download the data log of the optional local temperature monitoring to a USB memory device. You will use the USB port to download and clear the data log when the storage is full. The USB port can also be used to update the firmware. Verify that the port is intact by inserting the USB drive (not included) and looking for the USB icon in the icon bar at the top of the LCD display.

7.1.2.2 Data Monitoring Backup Battery

Activating the Battery: The included battery is shipped with a protective tab so that its power doesn't drain. To activate it you must remove the tab from its location inside the I/O Dock panel.

Replacing the Battery:

1. Open the I/O Dock panel
2. Remove and replace the battery with only type CR123A
3. Close the I/O Dock panel

Note *The battery serves to support continuous temperature monitoring during power outages and will need to be replaced periodically.*



When replacing the battery, replace only with a CR123A or IEC16340 type battery.

Note *We recommend that you keep spare batteries on-hand. This battery will allow you to continue to monitor internal temperature even in the event of a power outage.*



This battery will not power the refrigeration. You must ensure uninterrupted power to the refrigerator and monitoring system at all times.

7.1.3 Ventilation

The TSX refrigeration system is a solid-state system utilizing fans with moving parts. The functioning of the fans is integral to heat dissipation. The fans are mounted on the top of the unit. They will run continuously until the preprogrammed temperature set point is achieved. After that, the fans will run at a slower speed when needed to stabilize temperature.



Do not insert objects into the fan screens to avoid damaging the unit.

7.1.4 Door Lock

The 5.5 cu.ft. refrigerator door locking mechanism is password protected. A user, sub-admin or admin password or PIN is required to unlock the refrigerator and gain access to stored product. A Universal Password/Pin is provided with the unit and must be entered upon the first/initial login.

Disabling the Door Lock: Users that wish to disable the door lock so that the door can be opened without entering a passcode can do so by following a few simple steps.

1. Log in to the refrigerator using the PIN.
2. Touch the unlock button on the home screen.
3. The door will now be unlocked.

4. Open the door and locate the lock bracket on the top side of the door.
5. Unscrew the two Philips head screws securing the bracket being very careful not to move the plastic bracket.

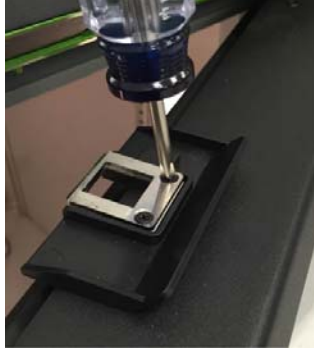

6. Remove the metal plates from the center of the bracket.
7. Reinstall the Philips head screws through to secure the plastic bracket as shown.

Note *While tightening the screws you may experience increased resistance before the screws are flush with the bracket. This is normal, apply a moderate level of torque until the screws are properly seated.*



7.2 Product Exterior – Rear

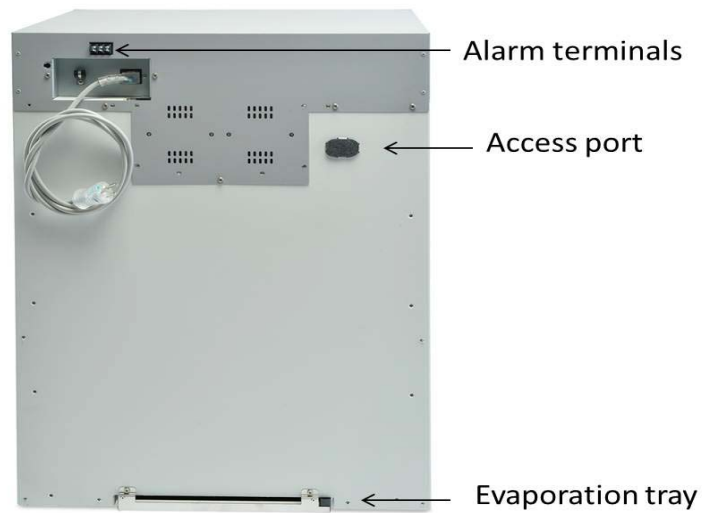

7.2.1 Access Port

The Access Port (located on the back of the unit) is shipped sealed with a foam plug that must be removed prior to use. Additionally, the red plastic knock-out must be removed. After inserting your device, we recommend reinserting the foam plug as snug and flush as possible to insulate against cooling loss. Putty may also be used to help reseal the area.

7.2.2 Evaporation Tray

The evaporation tray is located on the bottom rear of the unit.

7.3 Product Interior



7.3.1 Interior Components

- Glycol temperature sensor port and sample bottle
- Air temperature sensors (2)
- External pass-through port
- Adjustable shelving
- Adjustable LED lighting

7.3.2 Adjustable Shelving

Your TSX undercounter refrigerator is shipped with wire ties holding the shelves in place. Remove the wire ties before using the refrigerator. You may place the shelving wherever you choose by removing and relocating the support clips.

8 Navigating TSX 5.5 Cu.Ft. Refrigerator Controls

8.1 System Icons

system icons



USB



Defrost



Battery

8.2 System Prompts

prompt icons



Insert a USB Drive



USB Drive Detected









Data Log Saved







Error Saving Data Log

8.3 System Alerts

alert icons

-  Air Temperature Range
-  Glycol Temperature Range
-  Memory Low
-  Door Ajar
-  Battery Low
-  Loss of Power

8.4 System Alert Values

Alarm	Factory Setting	Icon
Temperature Range Alarm	min 2 °C max 8 °C	
Door Ajar Alarm	1 minute	
No Power Alarm	> 10 seconds outage	
Battery Low Alarm	< 30% remaining	
Memory Full Alarm	< 30% remaining	

8.5 Reading the LCD (Temperature) Display

The Temperature Display is preset to show the Glycol Sensor reading, measured in Celsius and to the tenth of a degree. The current temperature, date and time are displayed in every screen in the graphic user interface with the exception of the screen where an administrator, sub-administrator or user enters their password to unlock the door.



8.6 Login and Unlock Door

8.6.1 Login

1. Tap the Login button to bring up the Password/Pin entry screen.
2. Tap in the appropriate 4-digit Password/Pin (a Universal Password/Pin is provided with the unit and must be entered upon the first/initial login).
3. Tap/Select the Check button.

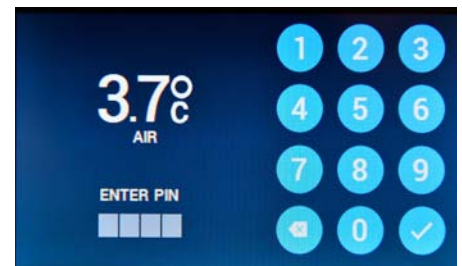

8.6.2 Unlock/Lock Door

1. After entering the Password/Pin, tap/select Unlock.
2. Tap/select the Lock button to lock the door.

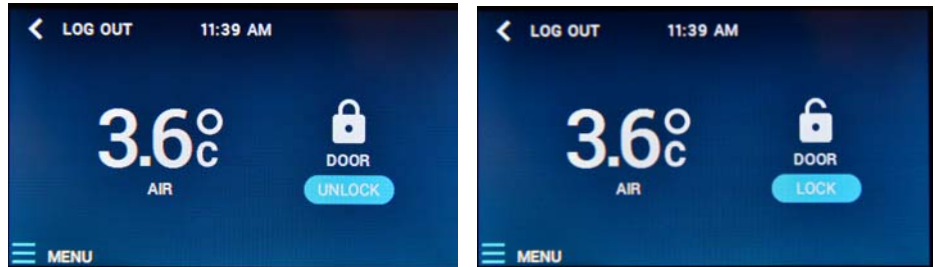

8.7 Access the Main Menu

1. Access to the main menu is available to Admin, Sub-Admin and User.
2. After logging in and unlocking the door, tap the menu icon in the lower right corner of the display.
3. The Main Menu will appear where an Admin (System Administrator) can select from Alarms, Data Log, Settings or Administrator Tools. A Sub-Admin login will have limited access with the ability to monitor and adjust Alarms, Data Log and Settings menus. A User login will have further limited access with the ability to monitor and adjust Alarms and Data Log menus.

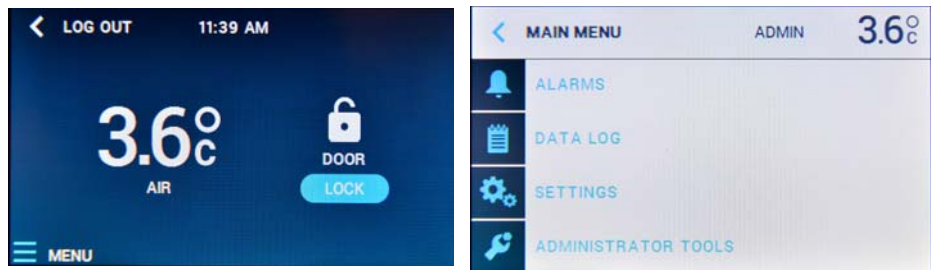

8.7.1 Alarms

8.7.1.1 Active Alarms

The Active Alarms screen displays a list of active alarms and is one of the ways that an alarm can be cleared. Tap Active Alarms to access the Active Alarms display.

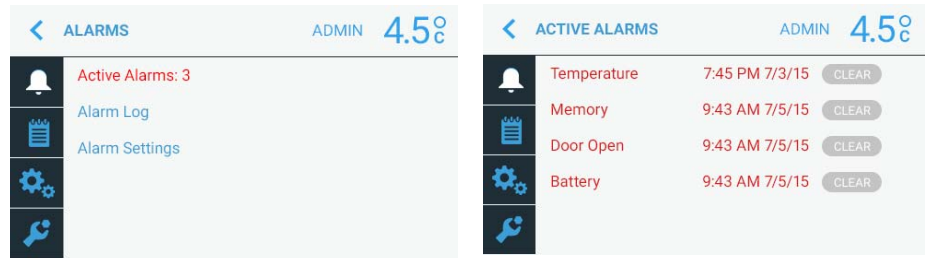

8.7.1.2 Alarm Log

The Alarm Log screen displays a history of all alarms with the time and date each alarm occurred. The Alarm Log screen displays a list of recent alarms per alarm category.

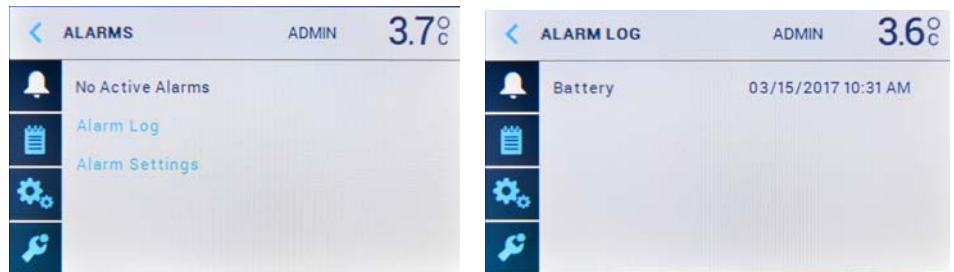

8.7.1.3 Alarm Settings

The Alarm Settings menu allows the user to check and adjust all Alarm Settings. Using the left or right arrow lets you scroll through the possible Alarm Setting options. Use the up or down arrow to scroll through the settings.

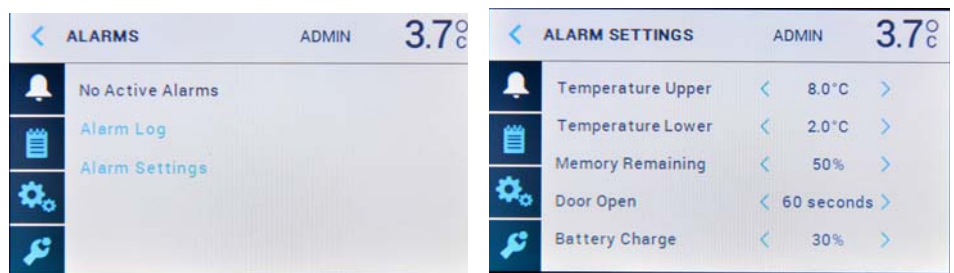

8.7.2 Data Log

Data log is part of the local temperature monitoring accessory and can be added to any TSX refrigerator.

8.7.2.1 Min/Max Temperatures

8.7.2.2 Downloading Data

Download Data Log is where the stored historical data is download to a USB device.

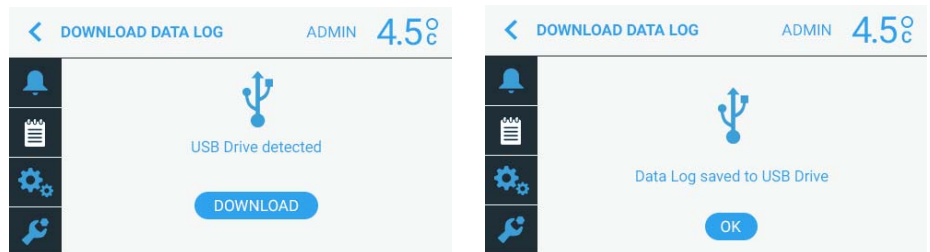
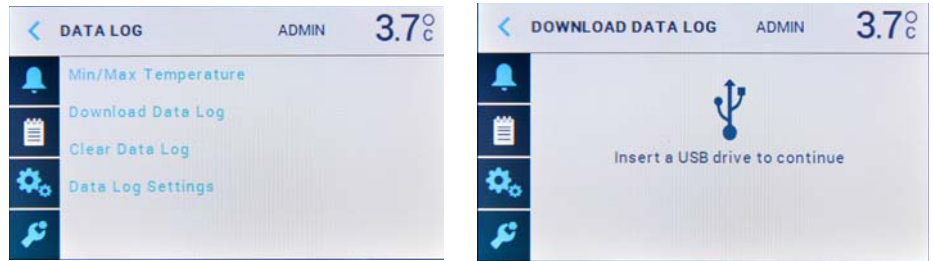

Selecting the Download Data Log will prompt the user to insert a USB drive. Once the USB drive is inserted, the user is notified that the USB drive has been detected by the system. The user then selects Download from the display and once the data download is complete (normally just a few seconds), the user is prompted that the Data Log has been saved to the USB drive.

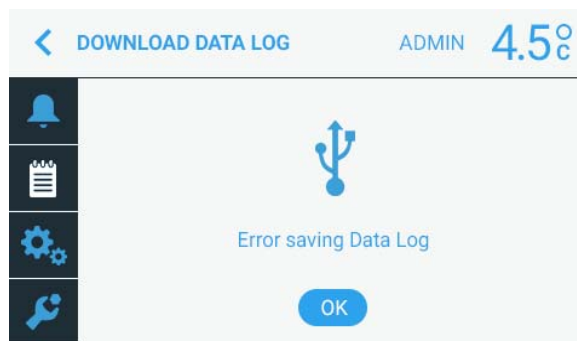

If the user sees the Error saving Data Log screen, there is a compatibility issue with the USB drive OR the USB drive may have other files on the USB drive that interfere with the download. It is recommended that the same USB drive is used for continuous data downloads.

8.7.2.3 Uploading Data to a Computer

Our system allows you to upload your temperature logs to any USB flash drive for display and analysis on your spreadsheet software such as Microsoft Excel™. When you're ready to review the data extracted on a USB flash drive (see instructions on how to download data above), simply insert the USB flash drive into your computer and open the file in Microsoft Excel™ or any program that can read a .CSV file.

8.7.2.4 Clearing the Data Log (after downloading)

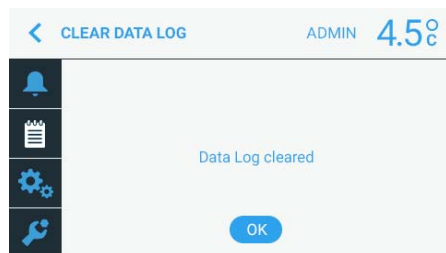
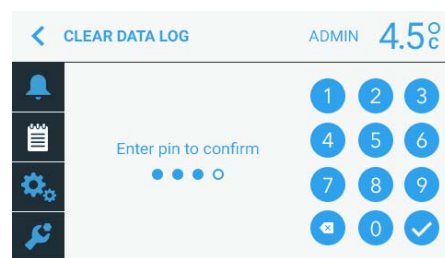
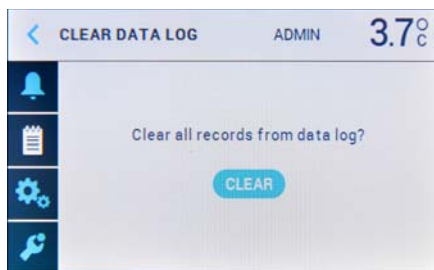

CAUTION: Clearing the log erases the memory and once erased, the data cannot be recovered.

Once the Data Log has been successfully downloaded, the user will be prompted to Clear Data Log. Selecting the Clear button will prompt the user for their appropriate Password/Pin. After the Password/Pin is entered, the Data Log will be cleared and the user must select OK.

Note *Clearing the data erases the memory and once erased, the data cannot be recovered.*

8.7.2.5 Reviewing / Adjusting Data Log Settings

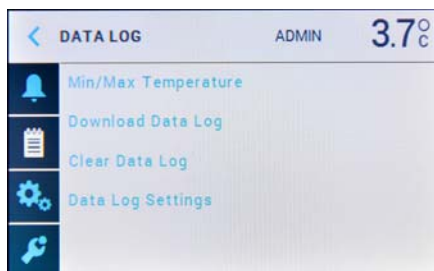

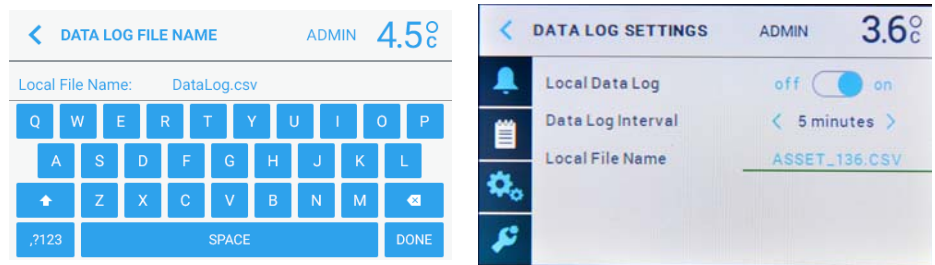

In the Data Log Settings menu, the user can turn on or off the on-board data logging feature, set the time for Data Log Intervals, selecting the Local File Name will prompt the user to manually enter the name of the file storage of the unit.



Note The data log feature is part of the local temperature monitoring accessory and can be added to any TSX refrigerator. Visit ThermoScientific.com for more information.

8.7.3 Settings

8.7.3.1 Temperature Set Point

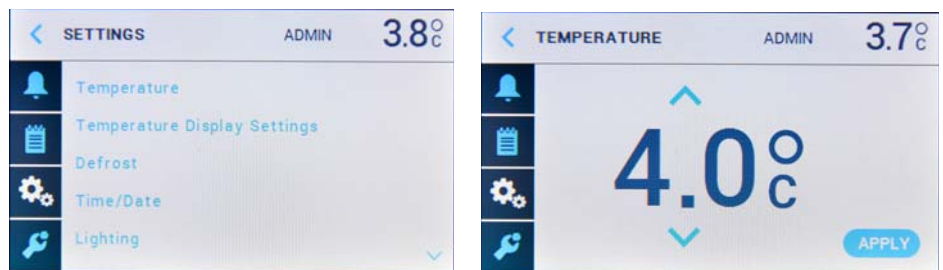

Temperature Set Point is where the user selects the desired unit set point. Using the up and down arrows allow the user to scroll through the preset temperature settings. The temperature is set once the Apply button is confirmed. Temperature settings are in 0.5 degree increments whether the display is set to Celsius or Fahrenheit.

Setting the proper desired temperature is one of your most important display settings. The TSX 5.5 cu.ft. refrigerator will hold your set temperature to within 0.5°C.

8.7.3.2 Temperature Display Settings

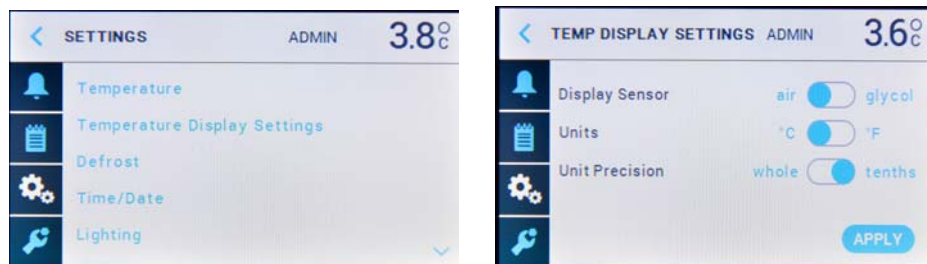

Temperature Display Settings is where the user selects the desired Display Sensor to Air or Glycol temperature reading. By sliding the selection left or right, this screen is also where Units are set to either °C or °F and setting the Unit Precision to whole or tenths of units.

8.7.3.3 Defrost

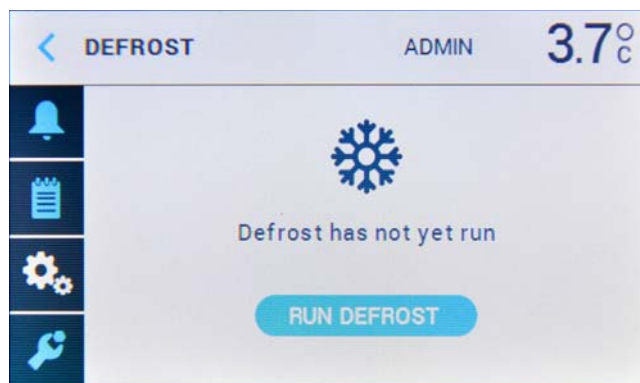

Selecting Defrost from the Settings menu will prompt the user to set-up and run a manual defrost. The Defrost screen also shows when the unit ran a defrost function last.

8.7.3.4 Date/Time

Select Date/Time to manually set-up the current date and time. This is important to have correct for data logging and alarm event purposes. The initial screen shows the time and date entered and prompts the user to set the time and date. When setting the time, the user can select between a 12 and 24-hour clock (standard time or military time) and AM or PM for a standard clock setting. Using the numeric keypad, the user enters the time and selects the check mark when finished. If the user selects to set the date the user is prompted to enter the current date and can select from the US standard mm/dd/yy or the optional dd/mm/yy setting and selecting the check mark.

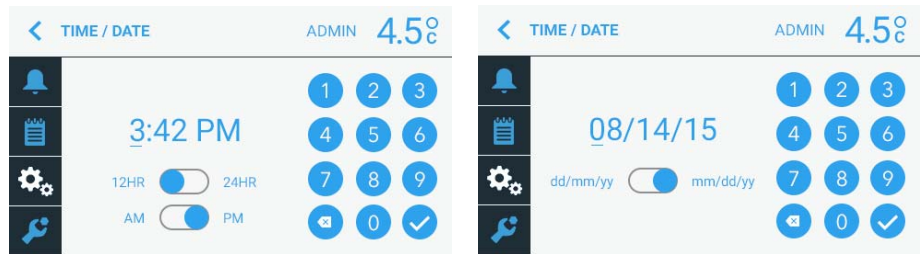
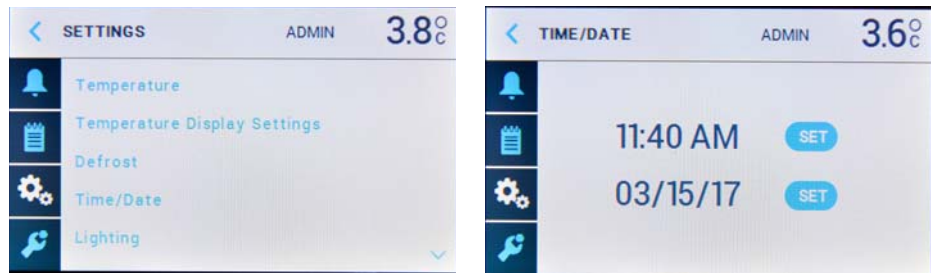

8.7.3.5 Lighting

Select Lighting to adjust the brightness level, lighting on with door open and the duration of the lighting to remain on after closing the door.

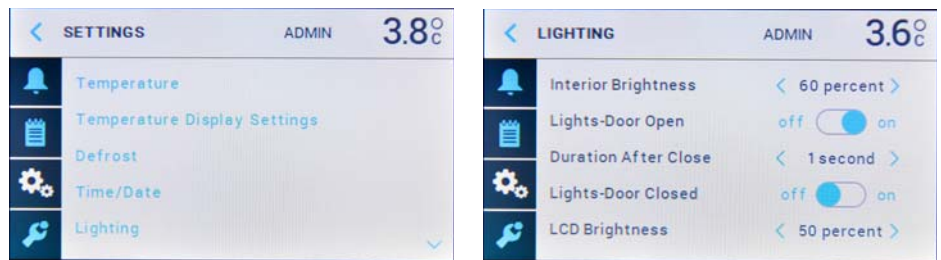

8.7.3.6 System Information

Selecting System Information from the Settings menu enables the user to view the key system information on the unit such as the product Serial Number and battery health. This is an important area where the user can see the product Serial Number, MAC Address, IP Address and Firmware Versions.

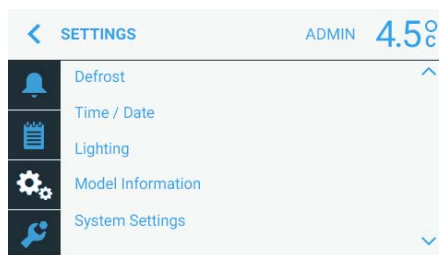

8.7.4 Administrator Tools

8.7.4.1 Edit Users

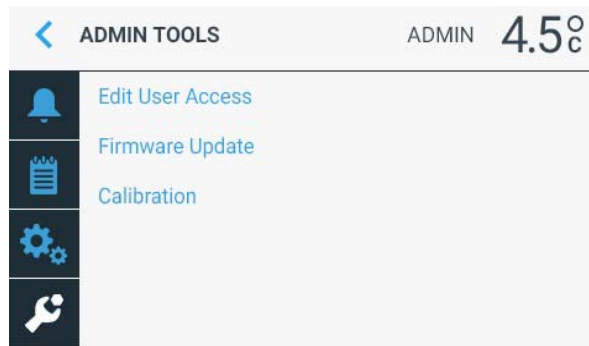

From the main menu, Admin Tools is the section in the controls where users are listed and passwords can be edited.

8.7.4.2 Firmware

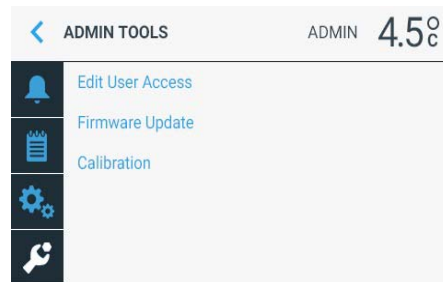

Firmware updates are conducted via the Admin Tools. A firmware update is in a BIN file format. The BIN file must be saved or uploaded to a USB drive. The user will be prompted to insert the USB drive. Once the BIN file is located and selected by the system, the user taps Apply. The control will then display a screen acknowledging that the new, updated firmware is being applied. When the upload is complete the display screen will confirm that the new firmware has been successfully applied.

8.7.4.3 Calibration

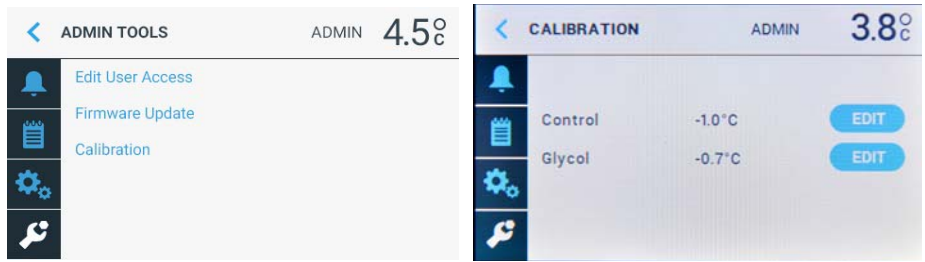

When Calibrating, it is recommended to Calibrate the Control sensor first and allow time for the system to equilibrate before making any adjustments to Glycol. An example of calculating an offset value: Your NIST certified temperature reading is 3.7°C, the unit reading is 4.2°C, the offset would be -0.5°C.

9 Periodic Product Maintenance

Use of cloth to wipe interior:

With cold wall refrigerators, condensation may form on the interior of the cabinet and may require periodic wipe-down with an absorbent cloth.

Suitable products for cleaning interior/exterior:

The interior may be cleaned, when needed, using a mild detergent and a damp cloth. We recommend using a stainless steel cleaner on the exterior.



IMPORTANT Avoid the use of chlorides (cleaners with bleach) as well as abrasive cleaners and scrubbers such as steel wool. They will degrade the protective coating on the stainless steel and leave it vulnerable to rust.

Cleaning around ventilation area and precautions:

Periodically inspect and monitor the ventilation area just above the door for dust accumulation. It may be cleaned with a duster or vacuum cleaner with a dust attachment.

Note *Do not remove the top cover. Do not attempt to clean the power supply located below the fan assembly. You could damage your unit.*

Cleaning the Catch Tray:

The catch tray is found on the bottom rear of the exterior cabinet. The bottom shelf can be removed for periodic cleaning or when excessive moisture or spills effect the bottom of the unit.

10 Frequently Asked Questions

How does this refrigeration technology work?

TSX uses a non-toxic, non-hazardous refrigerant embedded in the walls to absorb and channel heat energy to an internal, solid-state heat pump. The heat pump cools the refrigerant material when it channels the heat energy out of the system and into the ambient environment.

How reliable is the system?

We have conducted strenuous-life testing studies to develop confidence in the construction and system design of our refrigerator. Our studies indicate at least a 10-year life expectancy based on these stringent test protocols. TSX systems have no internal mechanical parts, are easy to operate and require minimal maintenance.

What is the product warranty?

Thermo Scientific offers a 2-year product warranty on parts and labor and a 7-year warranty on the PHP part.

Is the power cord healthcare/NEMA approved?

Yes, it is a National Electrical Manufacturers Association (NEMA) approved plug (indicated by a green dot on the cable).

Why is there a battery?

The included internal, standard-sized, non-rechargeable lithium CR123A battery provides continuous power to internal data logging.

How long before I can use the product?

In a normal ambient environment, your refrigerator should pull down to the target set point within a couple of hours. It is common industry practice to monitor the unit over 48 hours to ensure it is holding the set point temperature.

Why is there condensation building up on the walls?

Condensation is completely normal in a cold wall refrigeration system. Condensation occurs when humid air cools when in contact with the cold walls and excess water vapor condenses on the walls as droplets. There is an out-of-sight system that collects and evaporates the excess runoff. You may see excess condensation during the initial cool down period.

Where can I find the Serial Number?

You can find your important and specific product information by accessing the control interface.

The product Serial Number can also be found on the shipping label (on the shipping box) and on the product label (on the side of unit).

Is the unit calibrated? Can I calibrate my refrigerator?

The refrigerator can be ordered with a National Institute of Standards and Technology (NIST) certificate. To ensure proper calibration in the working environment, both the air & glycol sensors can be calibrated. See the Calibration section for instructions.

What kind of refrigerator maintenance is required?

As a complete solid-state refrigeration system, there are no internal moving parts to be serviced. Occasionally you will want to check the external fans for dust build up and clean as necessary. Otherwise there is no maintenance required to keep the system working at peak performance.

May the units be placed in a Pyxis cabinet?

As with any electrical or mechanical system, heat accumulation in a closed environment can impact the cooling performance of the refrigerator. We recommend adequate ventilation in the back wall of the cabinet to dissipate heat outside of the cabinet.

11 Troubleshooting

Troubleshooting Problems	Customer Resolution
Unit doesn't power on	Check for proper installation of the power plug.
Unit's audible alarm doesn't sound when out of temp range?	<p>Did you just power up the refrigerator and is the system pulling down to set point temperature? Alarm will not sound until the set point is met.</p> <p>Did you have a recent power failure and is the system pulling down to set point temperature? Alarm will not sound until the set point is met.</p>
LED Display Issues	
Solid red Data logging error but unit is operating normal	Download data and clear the data log. If light remains red there may be another issue with the internal data log; download data and contact Thermo Scientific Customer Care.
Flashing Red Data logging error during power failure mode (15 second intervals)	Download data and clear the data log. If continues flashing red, possibly there's an issue with the backup battery power running low. Replace it with appropriate battery.
Not Lit Power failure and no battery backup power	No action required
Flashing Green Data Logging is active in a power failure mode (15 second intervals)	Restore power to the unit and confirm that the LED becomes solid green.
Interior Concerns	
Condensation I have frost forming on the walls	Are you opening the door frequently? If so, the cooling system is working hard to maintain the target set point and condensation may freeze on the walls. It will thaw during the next defrost cycle. Run a manual defrost cycle if desired.
I have condensation collecting on the walls	In a cold-wall system humidity will cause condensation to form on the walls.
Door doesn't close/closes incorrectly	Check to make sure something isn't blocking it from closing completely.
Door alarm keeps sounding	Check to make sure the door is properly aligned in the frame by looking for uneven surfaces. For example, is the gap from the hinge to edge equal in width all the way across the surface?
I can't hear any noise from the unit	Is the power on? Is the LED on front a solid green? If so, the unit is powered and operating normally. Once the refrigerator reaches its set point temperature then it will be very quiet during normal operating conditions.

Troubleshooting Problems	Customer Resolution
I hear more fan noise than normal	Has the temperature risen recently? Is the front free & clear for proper ventilation? If you've recently held the door open for an extended period of time or you put warmer product in the refrigerator then the unit is likely recovering to its set point temperature. Only be alarmed if you hear abnormal fan sounds.
How long do I have to wait before I can load the refrigerator?	Once the unit displays 4°C, you are safe to start loading. If loading with room temperature product, we recommend loading the refrigerator in small increments to avoid raising the temperature above the controlled temperature zone.
What is the difference between an air sensor and a glycol sensor?	The air sensor is located along the back panel and represents the open air temperature. A glycol sensor is the vial of liquid with a thermocouple inserted in the liquid. The glycol sensor is most representative of the typical product stored in the refrigerator. It will take the glycol sensor longer to reach the desired set point temperature and it will remain stable longer than the air sensor. The display is defaulted to read the glycol sensor.
System doesn't recognize USB drive	We recommend inserting the USB while the display is reading temperature (default screen). Once plugged in you should see a USB icon appear on the icon bar. If it doesn't register after a few attempts, try inserting a different USB memory stick. Contact Thermo Scientific customer service if this persists.
System doesn't download data to the USB	Did you confirm there is a USB icon on the icon bar? Is the LED on USB illuminating? Check the USB device to make sure there is space for the data file. Try using a different USB memory stick.
I got a system error code	Call Customer Care for assistance, 866-984-3766 Did you remove the red tab to activate the battery contacts? If the battery strength is low it needs to be replaced.

12 Product Warranty and Service

Thermo Scientific warrants to the original purchaser that the equipment shall be free from material defects in material and workmanship under normal use and service during the “Warranty Period,” defined as:

- i. A period of 2 years from date of purchase with respect to all parts, during which period Thermo Scientific shall cover the cost of parts and labor for repair and replacement, and
- ii. An additional period of 5 years with respect to the Thermo Scientific heat pump powering the refrigeration system, during which period Thermo Scientific shall cover the cost of replacement parts and shall charge Thermo Scientific’s standard labor rates for repair and replacement.

CONDITIONS OF WARRANTY

1. Equipment must have been installed and operated in compliance with instructions provided by Thermo Scientific.
2. Warranty labor must be performed by a local Thermo Scientific authorized service agent.
3. Defects caused by alterations, improper operation, outdoor use, neglect, vandalism, fire, acts of God, or any situation or causes beyond the control of Thermo Scientific are not covered by this warranty.
4. Thermo Scientific may require that any parts covered under this warranty be returned to Thermo Scientific freight prepaid, and this warranty shall apply only if Thermo Scientific verifies the applicable defect upon examination.
5. Any defects or other damages resulting from shipment of the unit are not covered by this warranty. Thermo Scientific advises customers to carefully examine all shipments prior to acceptance and note all potential damage concerns on the appropriate shipping papers.
6. Labor charges resulting from security clearance procedures, safety training, travel time greater than one hour or 50 miles (80 km), premium time labor (including after hours, weekends, holidays, etc.), and service calls for non-defective equipment will not be covered by Thermo Scientific and are the responsibility of the equipment owner.
7. The repair or replacement of defective parts in accordance with this warranty is customer's sole and exclusive remedy with respect to any defects in the equipment. Thermo Scientific will not be liable for any consequential damages, expenses, connecting or disconnecting charges, or any losses or damages resulting from a defect in the equipment.
8. This warranty constitutes purchaser’s sole and exclusive remedy regarding defects in the equipment and is expressly made in lieu of other

warranties, expressed or implied, including any implied warranty of merchantability or fitness for a particular purpose.

For any questions concerning this warranty please visit our website at ThermoScientific.com or contact Customer Care at 866-984-3766.

WEEE Compliance

WEEE Compliance. This product is required to comply with the European Union's Waste Electrical & Electronic Equipment (WEEE) Directive 2012/19/EU. It is marked with the following symbol. Thermo Fisher Scientific has contracted with one or more recycling/disposal companies in each EU Member State, and this product should be disposed of or recycled through them. Further information on our compliance with these Directives, the recyclers in your country, and information on Thermo Scientific products which may assist the detection of substances subject to the RoHS Directive are available at www.thermo.com/

Great Britain



WEEE Konformität. Dieses Produkt muss die EU Waste Electrical & Electronic Equipment (WEEE) Richtlinie 2012/19/EU erfüllen. Das Produkt ist durch folgendes Symbol gekennzeichnet. Thermo Fisher Scientific hat Vereinbarungen getroffen mit Verwertungs-/Entsorgungsanlagen in allen EU-Mitgliederstaaten und dieses Produkt muss durch diese Firmen verwertet oder entsorgt werden. Mehr Informationen über die Einhaltung dieser Anweisungen durch Thermo Scientific, die Verwerter und Hinweise die Ihnen nützlich sein können, die Thermo Fisher Scientific Produkte zu identifizieren, die unter diese RoHS-Anweisung fallen, finden Sie unter www.thermo.com/

Deutschland



Conformità WEEE. Questo prodotto deve rispondere alla direttiva dell'Unione Europea 2012/19/EU in merito ai Rifiuti degli Apparecchi Elettrici ed Elettronici (WEEE). È marcato col seguente simbolo. Thermo Fisher Scientific ha stipulato contratti con una o diverse società di riciclaggio/smaltimento in ognuno degli Stati Membri Europei. Questo prodotto verrà smaltito o riciclato tramite queste medesime. Ulteriori informazioni sulla conformità di Thermo Fisher Scientific con queste Direttive, l'elenco delle ditte di riciclaggio nel Vostro paese e informazioni sui prodotti Thermo Scientific che possono essere utili alla rilevazione di sostanze soggette alla Direttiva RoHS sono disponibili sul sito www.thermo.com/

Italia



Conformité WEEE. Ce produit doit être conforme à la directive euro-péenne (2012/19/EU) des Déchets d'Equipements Electriques et Electroniques (DEEE). Il est marqué par le symbole suivant. Thermo Fisher Scientific s'est associé avec une ou plusieurs compagnies de recyclage dans chaque état membre de l'union européenne et ce produit devrait être collecté ou recyclé par celles-ci. Davantage d'informations sur la conformité de Thermo Fisher Scientific à ces directives, les recycleurs dans votre pays et les informations sur les produits Thermo Fisher Scientific qui peuvent aider la détection des substances sujettes à la directive RoHS sont disponibles sur www.thermo.com/

France



Important

For your future reference and when contacting the factory, please have the following information readily available:

Model Number: _____

Serial Number: _____

Date Purchased: _____

The above information can be found on the dataplate attached to the equipment. If available, please provide the date purchased, the source of purchase (manufacturer or specific agent/rep organization), and purchase order number.

IF YOU NEED ASSISTANCE:

Thermo Scientific products are backed by a global technical support team ready to support your applications. We also offer cold storage accessories, including remote alarms, temperature recorders and validation services. Visit www.thermoscientific.com or call:

USA/Canada	+1 866 984 3766	Germany international	+49 6184 90 6000
India toll free	1800 22 8374	Germany national toll free	0800 1 536 376
India	+91 22 6716 2200	Italy	+32 02 95059 552
China	+800 810 5118 (or) +400 650 5118	Netherlands	+31 76 579 55 55
Japan	+81-120-753-670	Nordic/Baltic/CIS countries	+358 9 329 10200
Australia	+61 39757 4300	Russia	+7 812 703 42 15
Austria	+43 1 801 40 0	Spain/Portugal	+34 93 223 09 18
Belgium	+32 53 73 42 41	Switzerland	+41 44 454 12 22
France	+33 2 2803 2180	UK/Ireland	+44 870 609 9203
New Zealand	+64 9 980 6700	Other Asian countries	+852 2885 4613
		Countries not listed	+49 6184 90 6000

Thermo Fisher Scientific Inc.

275 Aiken Road
Asheville, NC 28804
United States
www.thermofisher.com

thermoscientific

328277H01 Rev.A