



Instruction Manual: Enviro-Genie - PC Connection and Calibration

Table of Contents

Chapter 1: PC Connection 1
 1.1 RS232..... 1
 1.2 USB 3
 1.3 Wireless..... 6
 Chapter 2: Temperature Calibration..... 10
 2.1 One Point Calibration..... 13
 2.2 Two Point Calibration..... 14
 Chapter 3: Rotation Calibration 15
 3.1 One Point Calibration..... 18
 3.2 Two Point Calibration..... 19
 3.3 Three Point Calibration 20
 Chapter 4: Troubleshooting 21

Chapter 1: PC Connection

1.1. RS232

1. Connect the Enviro-Genie incubator with a laptop or a desktop PC via a 9 pin RS232 cable compatible with the Enviro-Genie incubator.

A DB9 to DB9 straight through serial cable is available from Scientific Industries, Inc. Part number ECP009

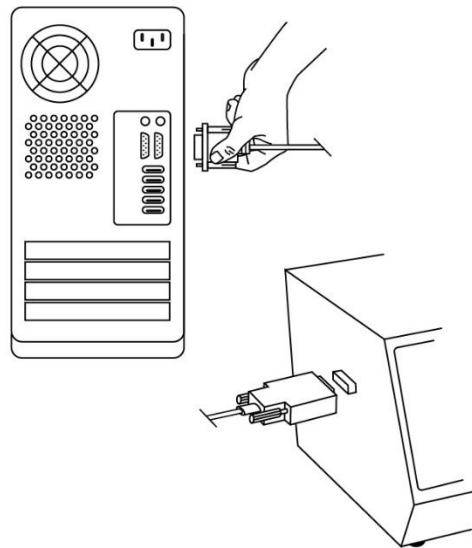

2. Open the EnviroApp and click Settings from the Home screen.

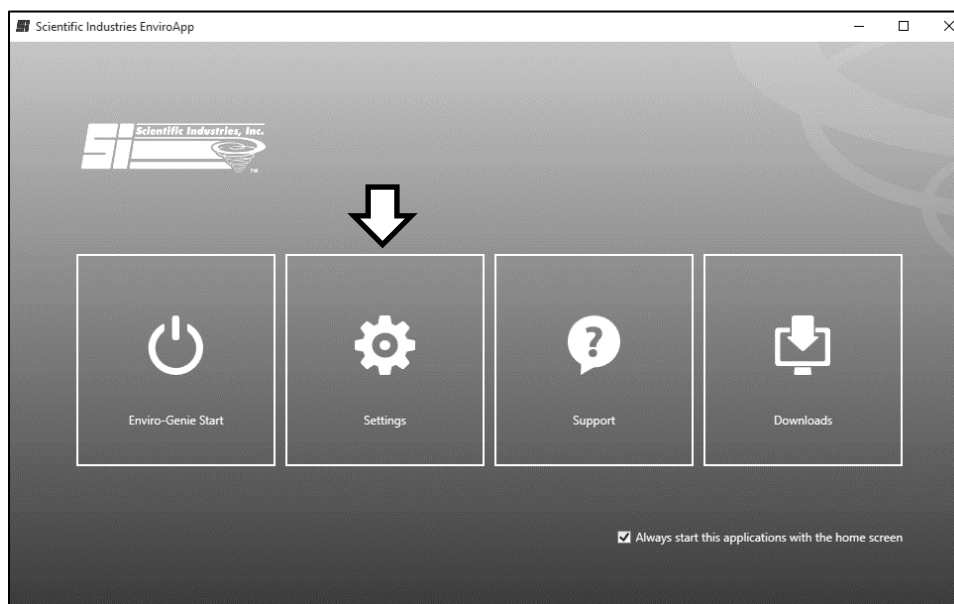

3. Select the COM port number used for the RS232 connection, or click Auto Detect to automatically detect the port number in use.

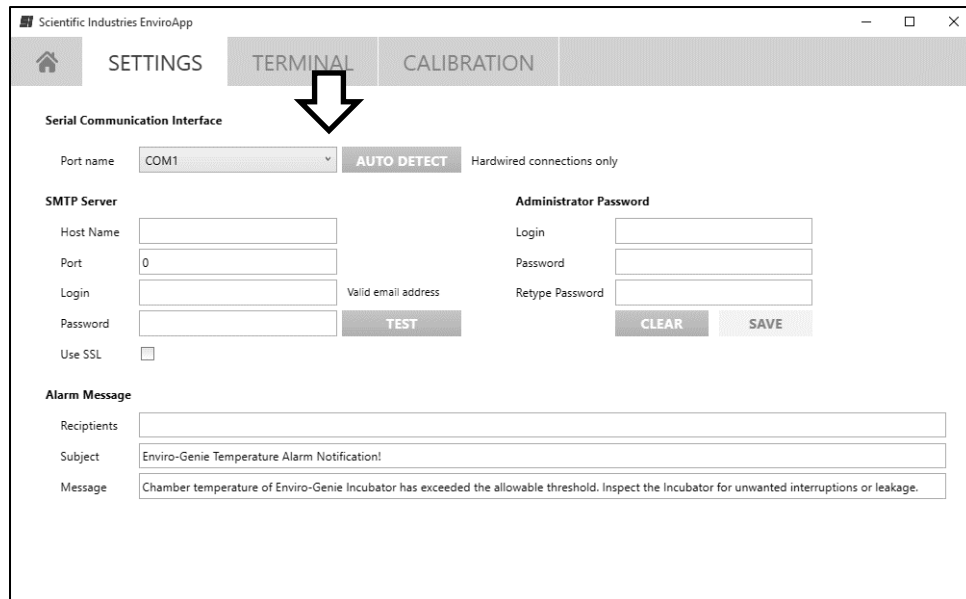

4. If the port is unknown and the EnviroApp was unable to detect the port automatically, use the Windows Device Manager to verify the COM port used for the RS232 connection.
5. To access Windows Device Manager, right-click on the Windows icon located in the lower left corner of the PC desktop, and select Device Manager.
6. In the Device Manager list, click on Ports (COM & LPT) to obtain the COM port used for the Enviro-Genie connection.

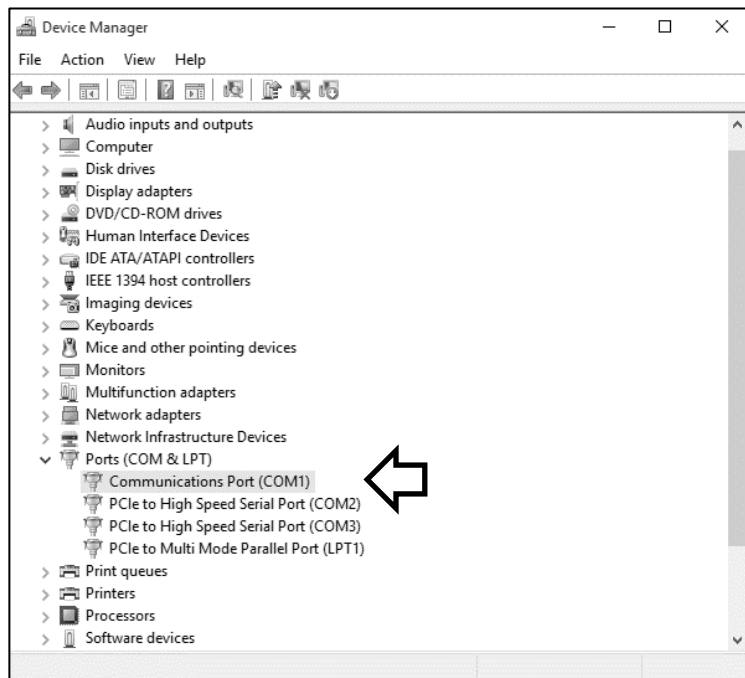
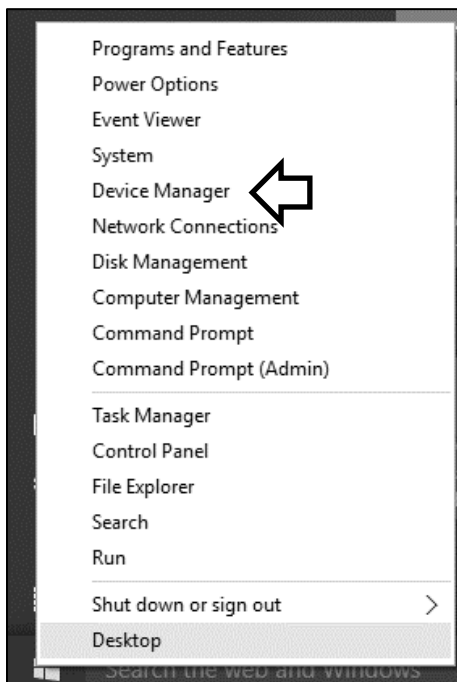

1.2. USB

1. Connect a compatible 9 pin RS232 cable to the RS232 port located on the left side of the Enviro-Genie incubator.

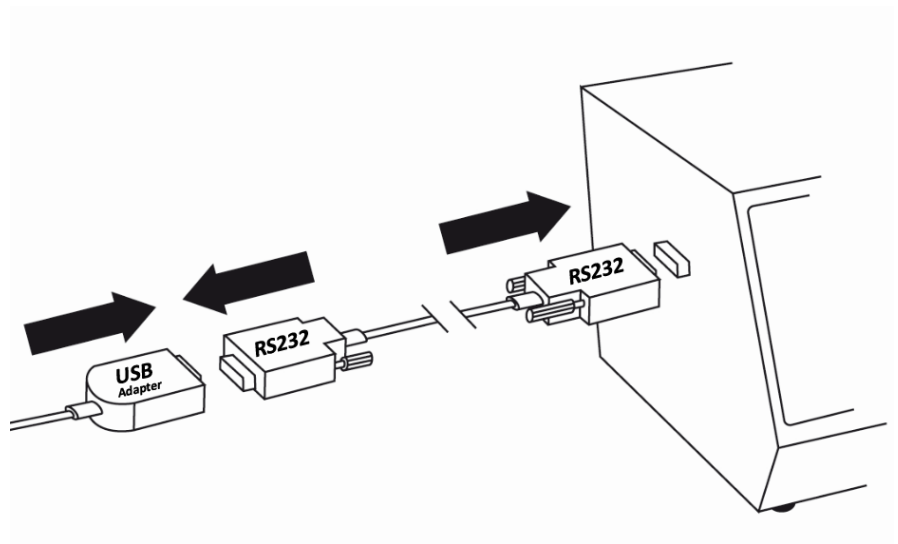

2. Attach an RS232-to-USB convertor to the RS232 cable connected to the Enviro-Genie

3. Plug in the USB cable to an available USB slot in your PC or laptop. Windows will begin automatic installation of device driver software. During driver installation observe the Device Setup window and note the COM port number assigned to the convertor.

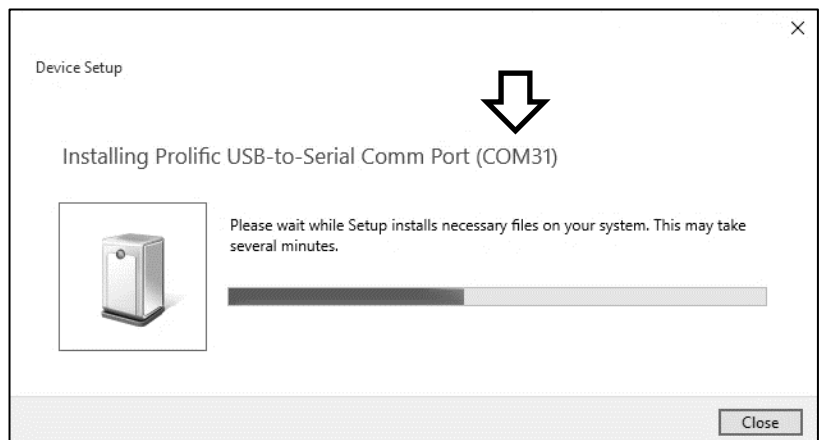
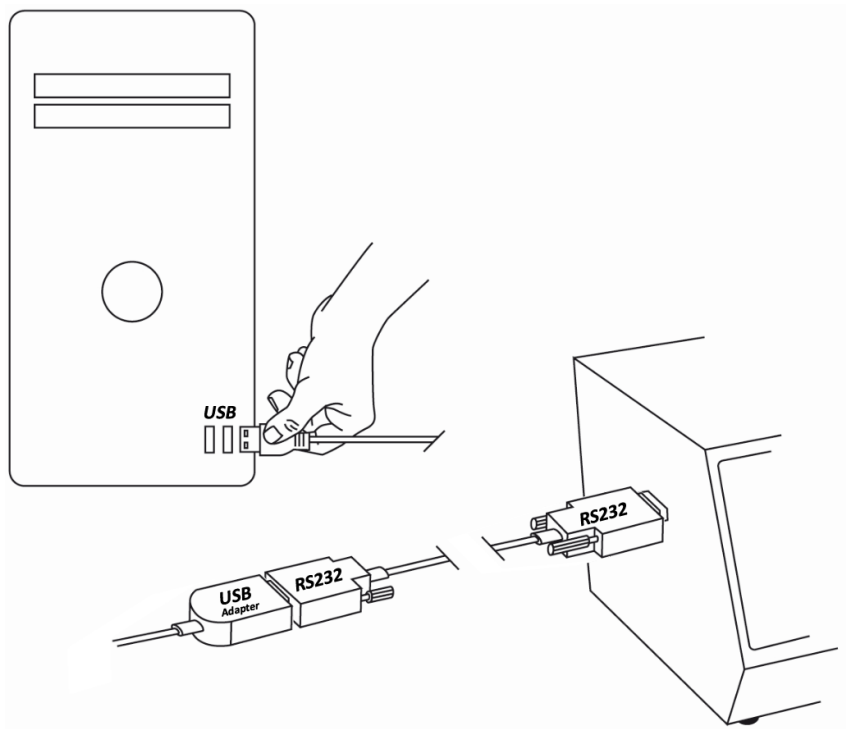

- Open the EnviroApp, and click Settings from the Home screen.

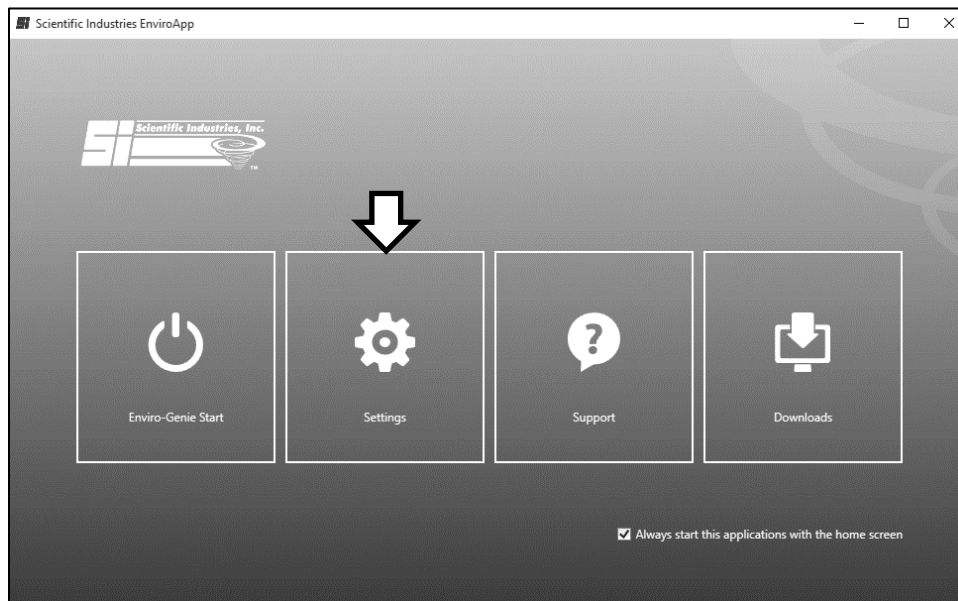

- From the Port Name list select the COM port number used for the USB connection, or click Auto Detect to automatically detect the port number in use.

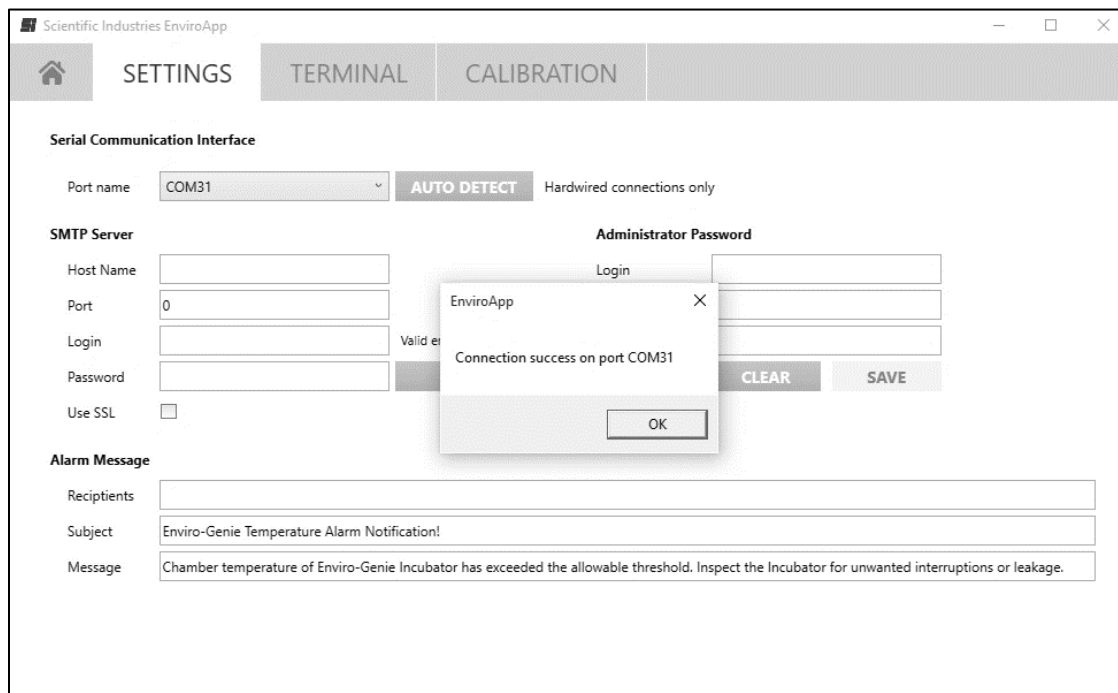

6. If the port is unknown and the EnviroApp was unable to detect the port automatically, use the Windows Device Manager to verify the COM port used for the USB connection.

7. To access Windows Device Manager, right-click on the Windows icon located in the lower left corner of the PC desktop, and select Device Manager.

8. In the Device Manager list, click on Ports (COM & LPT) to obtain the COM port used for the Enviro-Genie connection. The COM port assigned to the USB convertor will be labeled Prolific USB-to-Serial Comm Port.

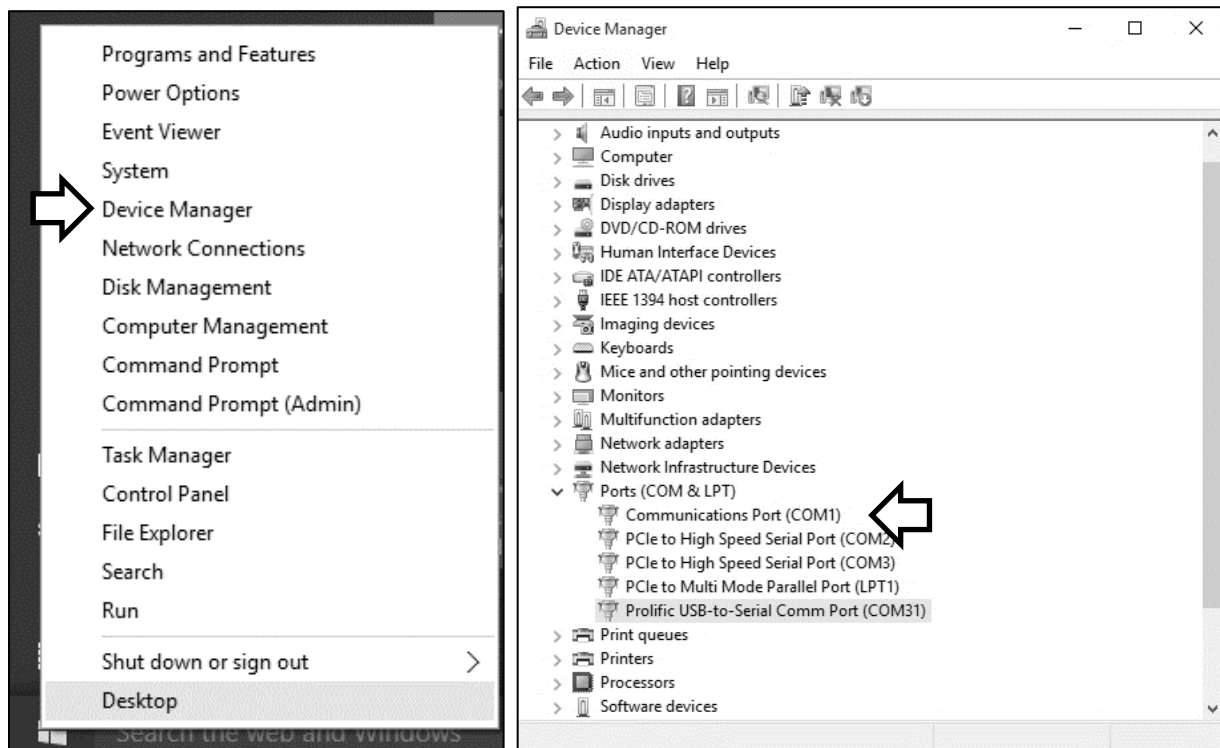

1.3. Wireless

1. Attach the wireless adapter to the RS232 port on the Enviro-Genie incubator. Fasten the adapter port screws to secure it firmly in place, and connect the antenna.

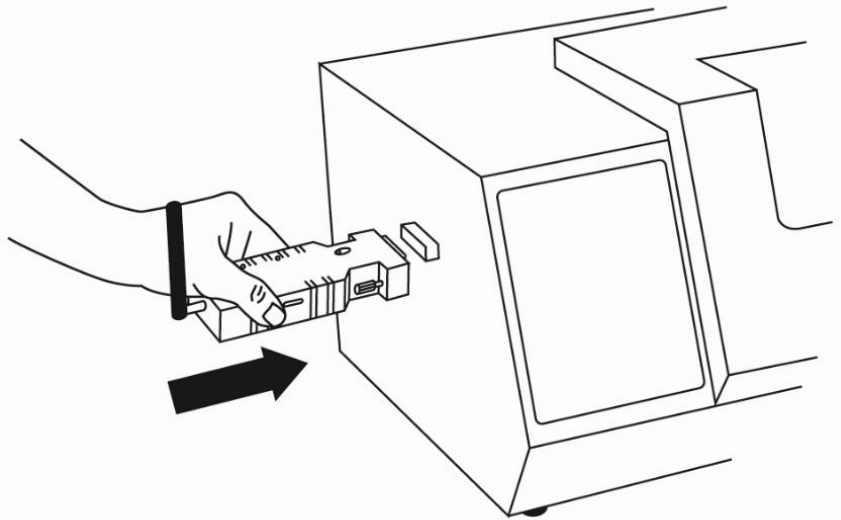

2. Plug in the power supply cable to adapter socket marked “5VDC”, and verify that slide switch on the adapter is in the “SEND” position, pointing towards the antenna connector.

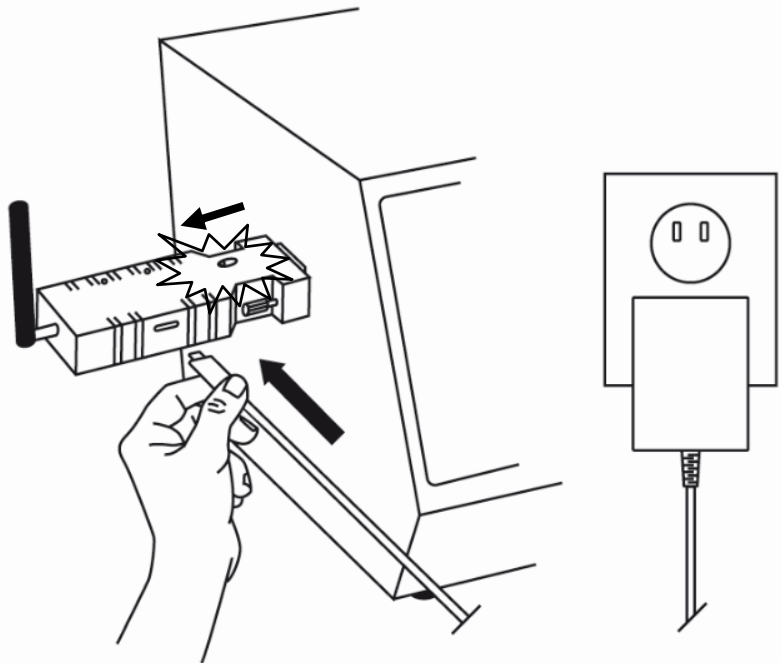

3. Make sure your PC is connected to the internet and allows drivers to be installed automatically. Plug in the Bluetooth dongle supplied with the wireless adapter to an available USB slot in your PC. Windows will begin automatic installation of device driver software.

Note: Skip this step if your computer or tablet already has a Bluetooth connection.

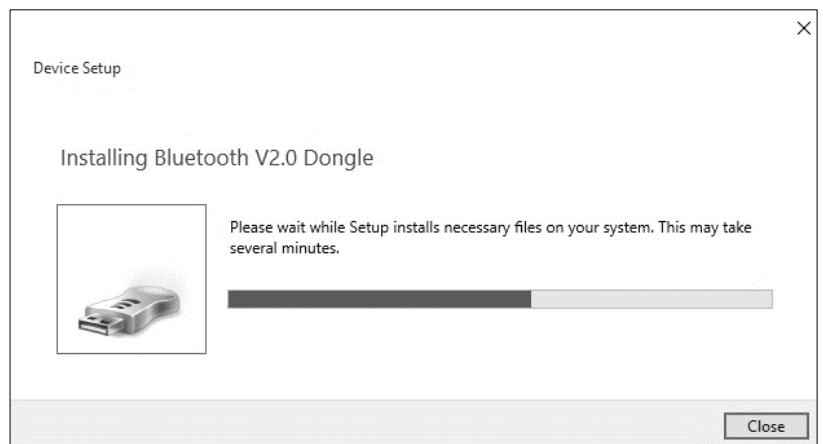

- Once the driver is installed, a Bluetooth icon will be visible in the task bar. Right click on the Bluetooth icon. The icon may be hidden, in which case expand your task bar to show all inactive icons. From the icon function menu select “Add a Bluetooth Device” to start the pairing wizard.

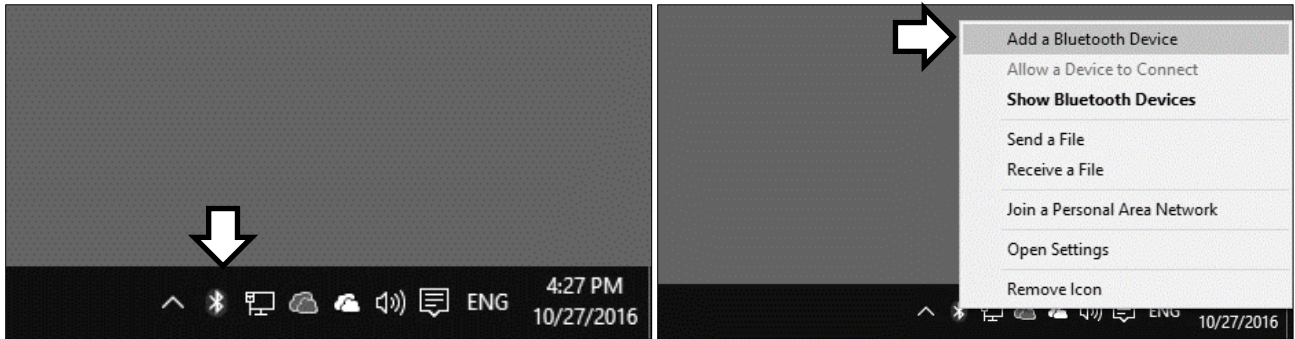

- Device window with available devices will appear on the PC screen. Locate device “Enviro”, click once to select it, and click on Pair to proceed.

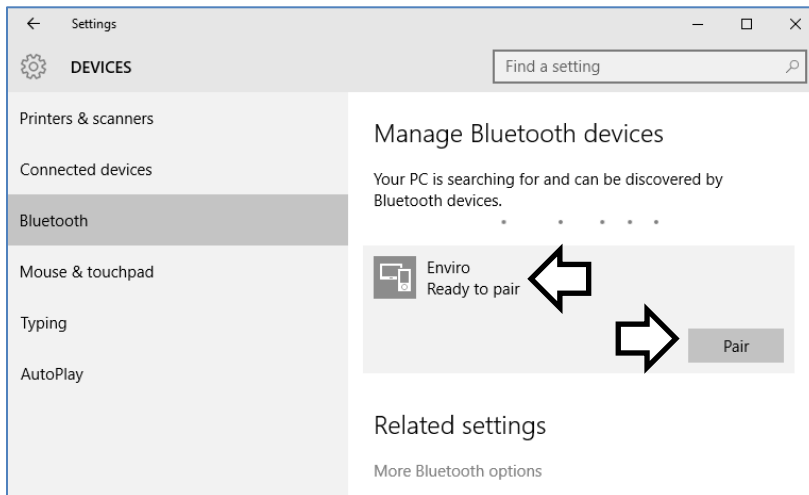

- Key in the pairing code: 867225. Click next to pair the Enviro-Genie incubator with your computer.

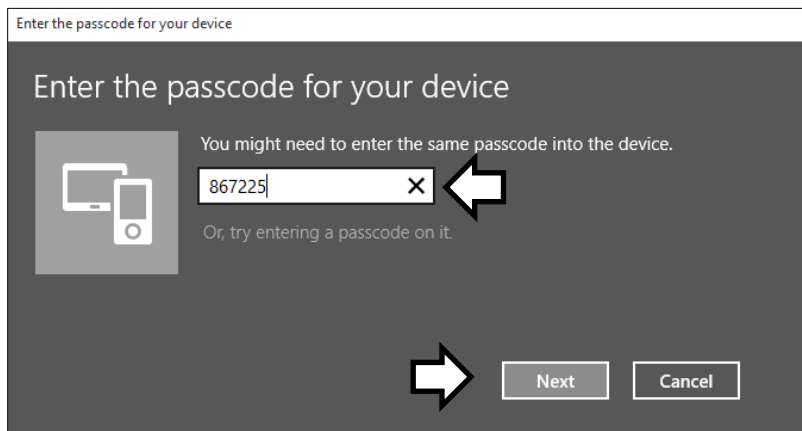

- Click on the Bluetooth icon located in your task bar and select “open settings”.

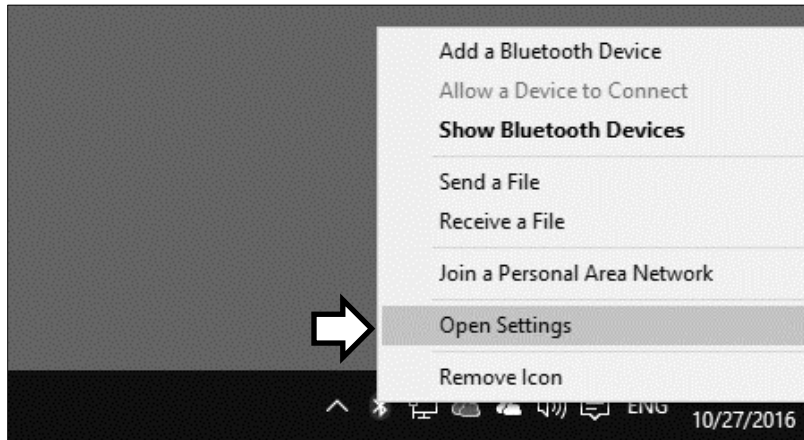

- For convenience check off option “show the Bluetooth icon in the notification area” in the Options tab. Click on the tab “COM ports”, the serial COM ports used by your computer for Bluetooth connections will be displayed. Note the outgoing COM port number for “Enviro ‘Dev B’”. This is the COM port used by the PC computer to transmit data between the Enviro-Genie incubator and the PC.

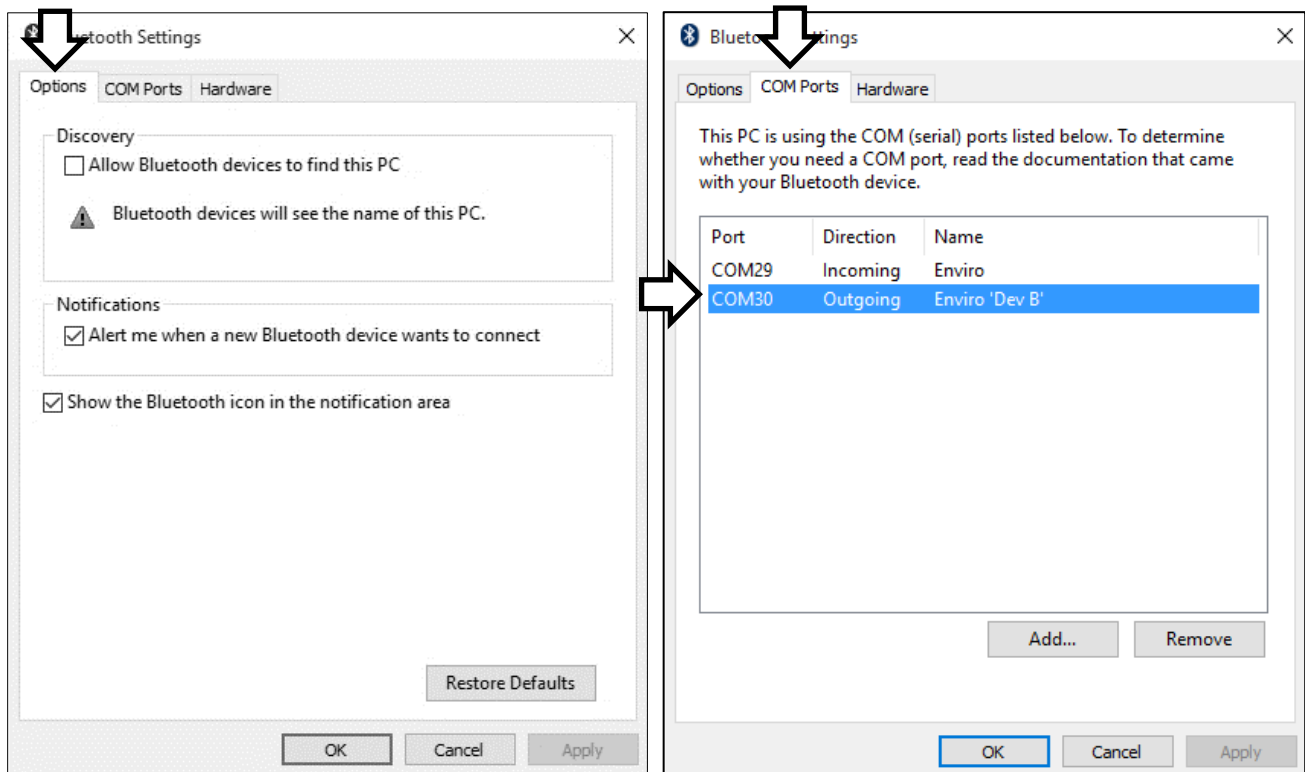

- Once the COM port number assigned to the Enviro-Genie Bluetooth has been verified, open the EnviroApp, and click Settings from the Home screen.

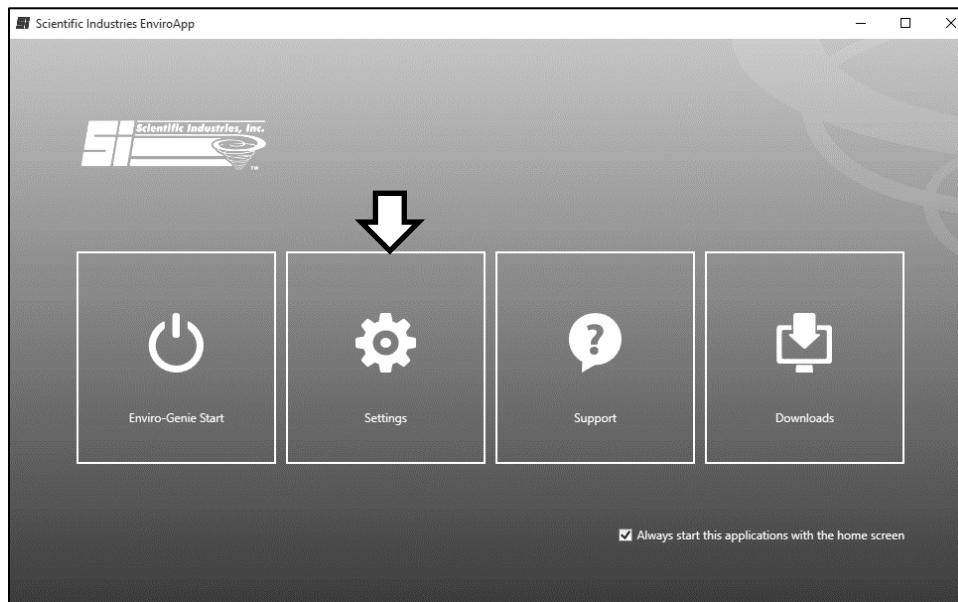

- From the Port Name list select the COM port number used for the Bluetooth connection.



Auto Detect is for hardwired connection only and cannot be used to detect wireless Bluetooth ports.

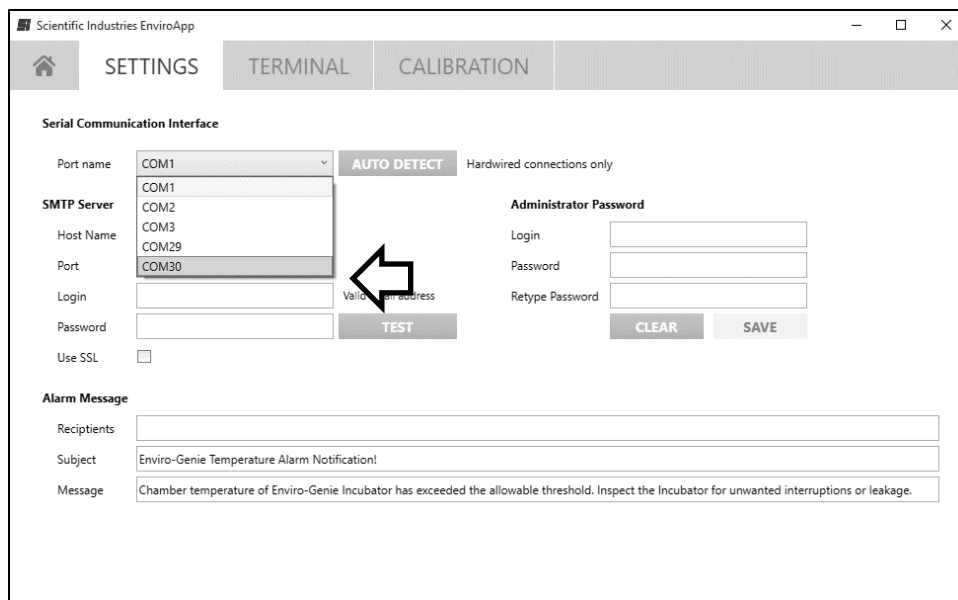

Chapter 2: Temperature Calibration



Calibration is a sensitive process and should be performed only with a trusted high accuracy reference device. Before calibration, verify the accuracy of your temperature sensor or tachometer. It is strongly recommended to calibrate with devices that have a valid traceable NIST certificate.

1. Before starting calibration, open the Enviro-Genie chamber and allow sufficient time for the incubator temperature to stabilize, and reach ambient room temperature.

2. Install or place a reference temperature sensor as close as possible to the fan located inside the Enviro-Genie chamber.

This fan is the exhaust from the chamber, and a probe directly in front of it will give the most representative temperature reading.

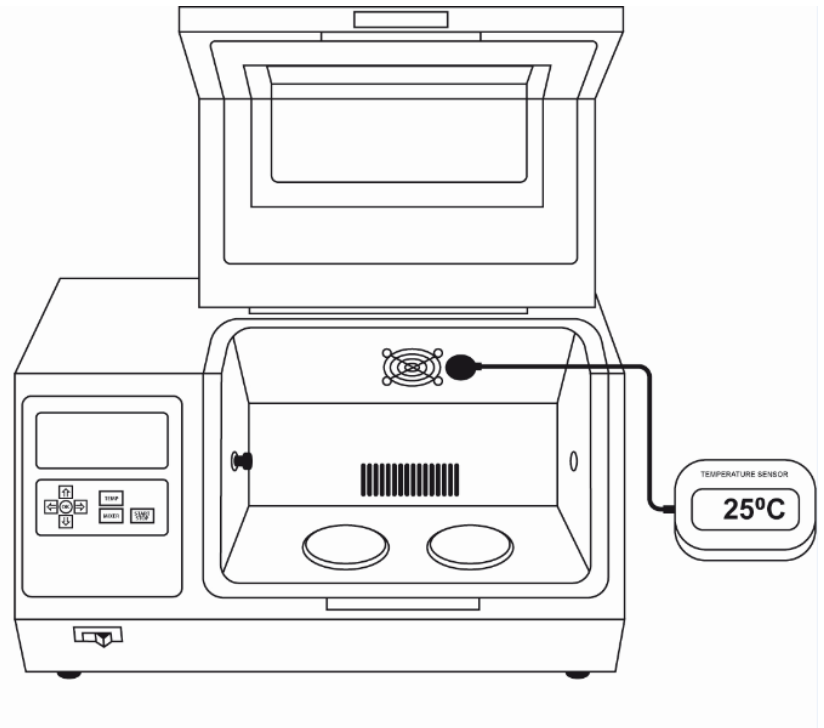

3. Carefully close the chamber and verify that the temperature sensor cable is not causing large gaps or opening in the incubator seal.

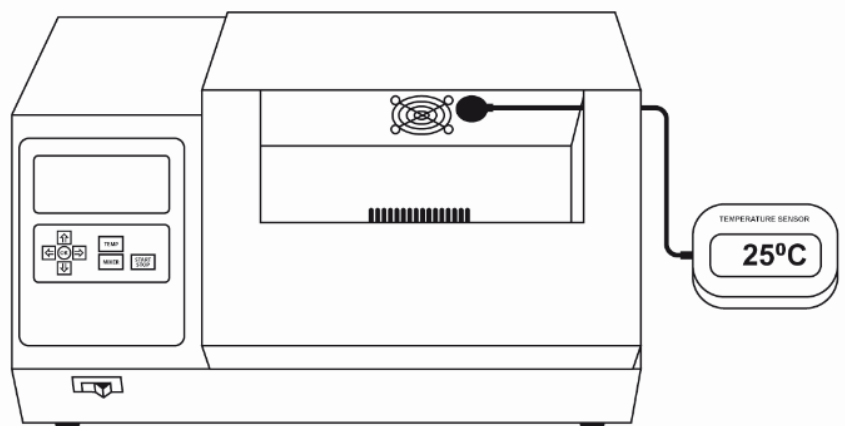

4. Set the Enviro-Genie to a desired temperature and verify the reading.

5. If calibration is required, open the EnviroApp and click Settings from the Home screen.

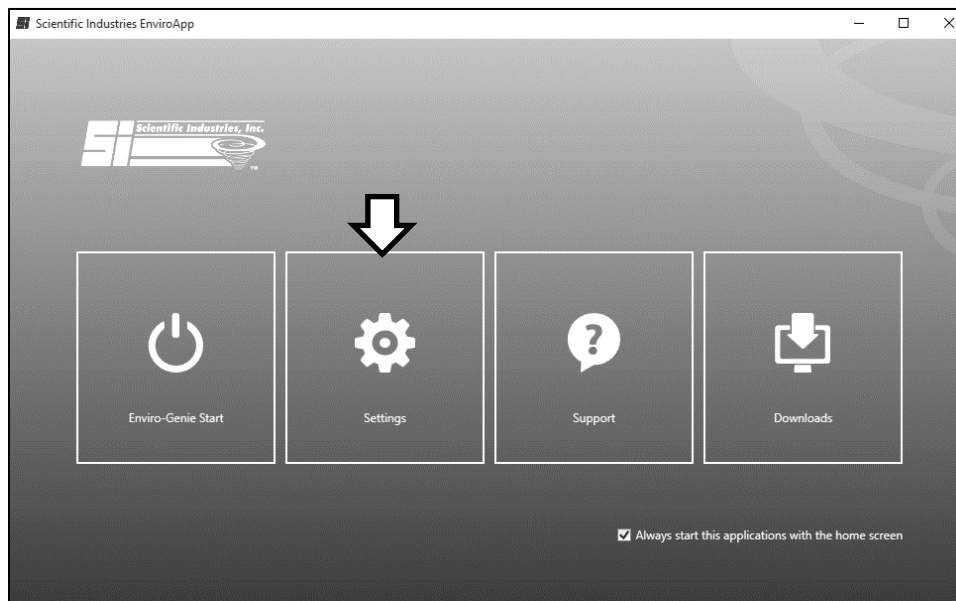

6. Select the Calibration tab and click on New Calibration.

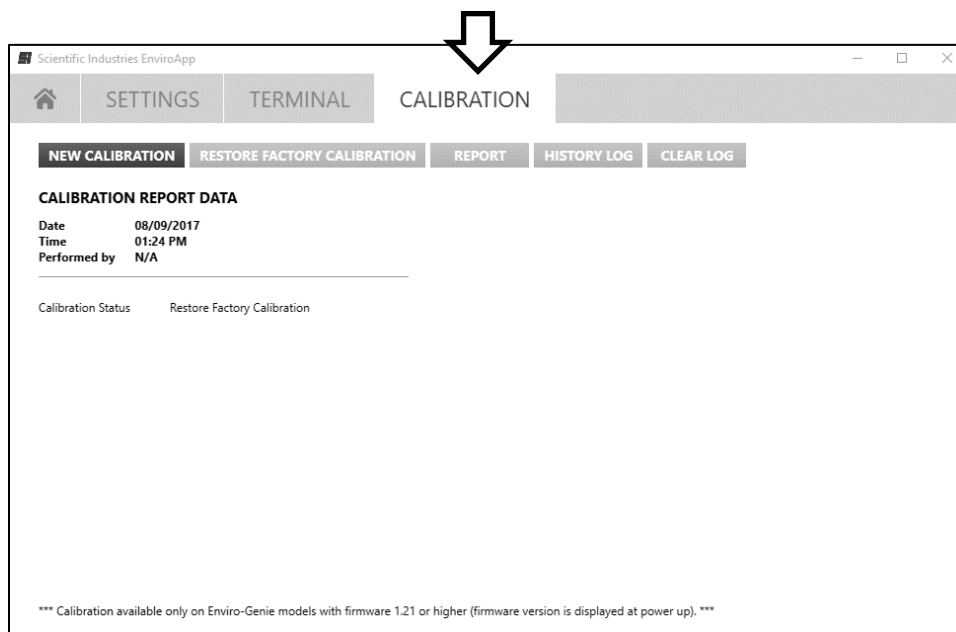

7. Wait for the Enviro-Genie incubator to start. Select the Calibration type, enter the name of the user performing the calibration, and click Next to continue.

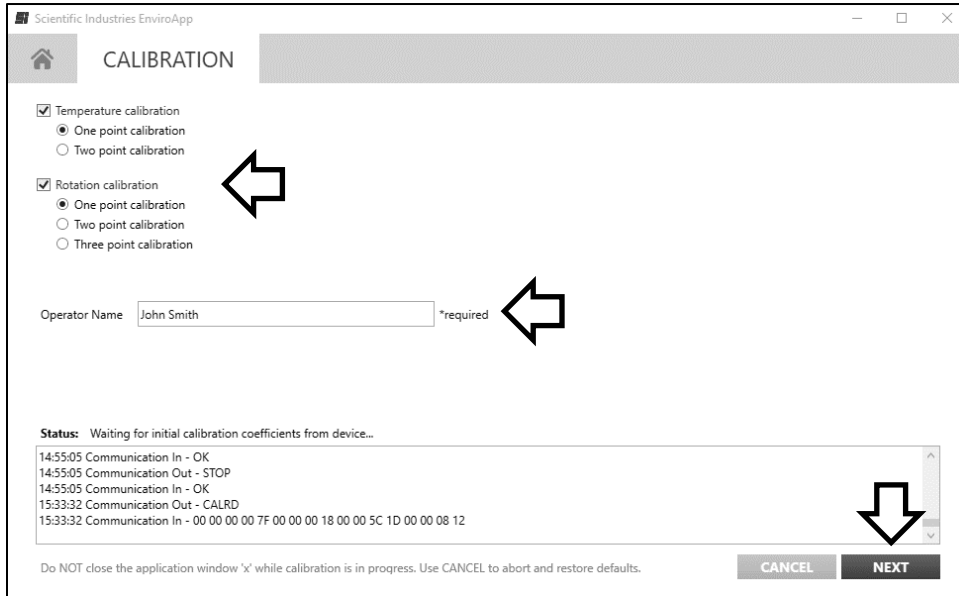

2.1. One Point Calibration

1. Enter a preferred Temperature Setpoint and click SET. “Please Wait” will flash in red while the Enviro-Genie reaches the set temperature.

One Point Temperature Calibration [Celsius degree]

Temperature Setpoint	30.0	SET
Current Enviro-Genie Temperature	30.5	PLEASE WAIT...
Reference Device Value	0.0	SAVE

2. Wait until the Enviro-Genie temperature reaches the Setpoint and stabilizes. Once the temperature setpoint is reached “Please Wait” will change to green and remain solid for 5 minutes. If necessary allow more time for the reference device to stabilize.

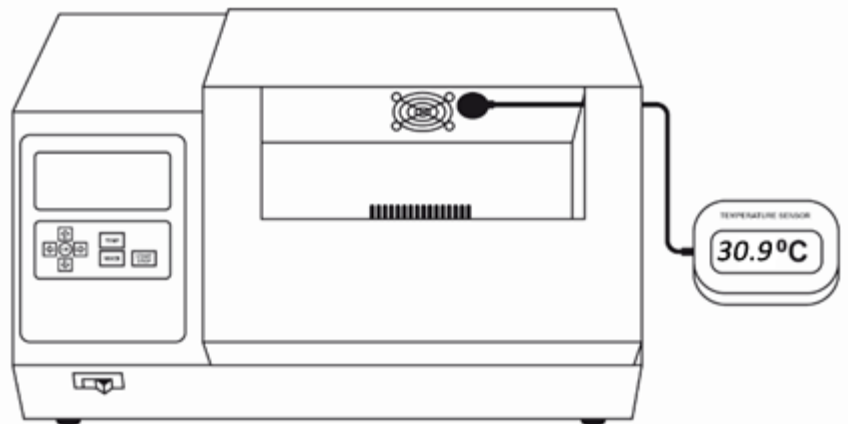

3. Once the reference device field becomes available, enter the reference device temperature exactly as indicated by the reference device and click SAVE.

One Point Temperature Calibration [Celsius degree]

Temperature Setpoint	30.0	SET
Current Enviro-Genie Temperature	29.9	
Reference Device Value	30.9	SAVE

4. Click NEXT to proceed and save calibration



Don not close the application window “x” while calibration is in progress. Use CANCEL to abort and restore defaults.

2.1. Two Point Calibration

1. Enter Low Temperature Setpoint One and click SET. "Please Wait" will flash in red while the Enviro-Genie reaches the set temperature.
2. Wait until the Enviro-Genie temperature reaches the Low Temperature Setpoint One and stabilizes. Once the temperature is reached "Please Wait" will change to green and remain solid for 5 minutes. If necessary allow more time for the reference device to stabilize.
3. Once the reference device filed becomes available, enter the reference device temperature exactly as indicated by the reference device and click SAVE.
4. Repeat steps 1 to 3 for High Temperature Setpoint Two.
5. Click NEXT to proceeds and save calibration

Two Point Temperature Calibration [Celsius degree]

Low Temperature Setpoint One	20.0	SET
Current Enviro-Genie Temperature	20.3	PLEASE WAIT...
Reference Device Value	0.0	SAVE
High Temperature Setpoint Two	40.0	SET
Current Enviro-Genie Temperature	20.3	
Reference Device Value	0.0	SAVE

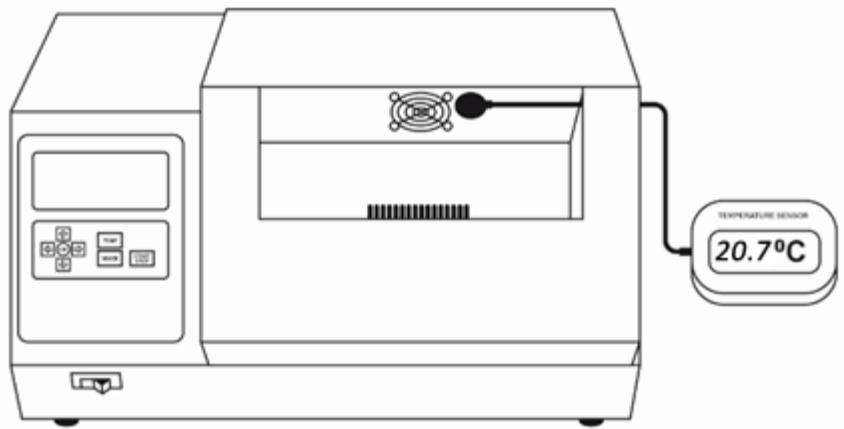

Two Point Temperature Calibration [Celsius degree]

Low Temperature Setpoint One	20.0	SET
Current Enviro-Genie Temperature	20.0	
Reference Device Value	20.7	SAVE
High Temperature Setpoint Two	40.0	SET
Current Enviro-Genie Temperature	20.0	
Reference Device Value	0.0	SAVE



Don not close the application window "x" while calibration is in progress. Use CANCEL to abort and restore defaults.

Chapter 3: Rotation Calibration



Calibration is a sensitive process and should be performed only with a trusted high accuracy reference device. Before calibration, verify the accuracy of your temperature sensor or tachometer. It is strongly recommended to calibrate with devices that have a valid traceable NIST certificate.

1. Open the Enviro-Genie incubator chamber and remove the magnetic platform as well any installed accessories.
2. Attach a precision tachometer to the tray shaft located on the left wall of the incubator chamber. Set the Enviro-Genie to a desired speed and verify the RPM speed of the incubator.

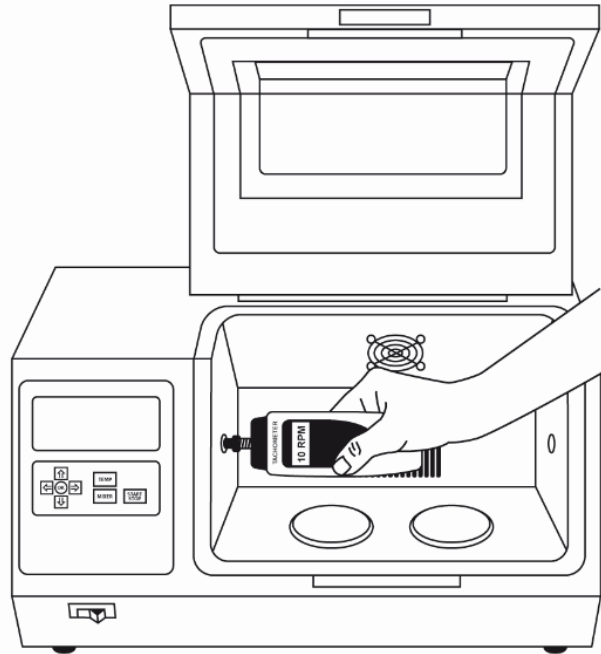

If you don't have a tachometer available, install the magnetic platform and use a stopwatch to accurately measure 360° rotations of the platform per minute. Use masking tape to mark a reference point on the front side of the platform and a connecting point on the incubator wall. This will assist in keeping track of the tray rotations.

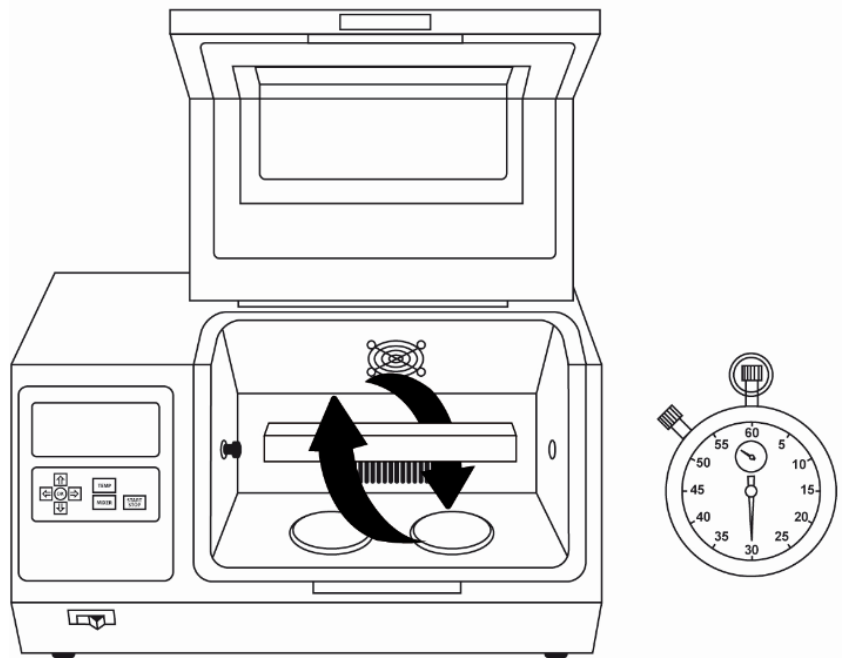

3. If calibration is required, open the EnviroApp and click Settings from the Home screen.

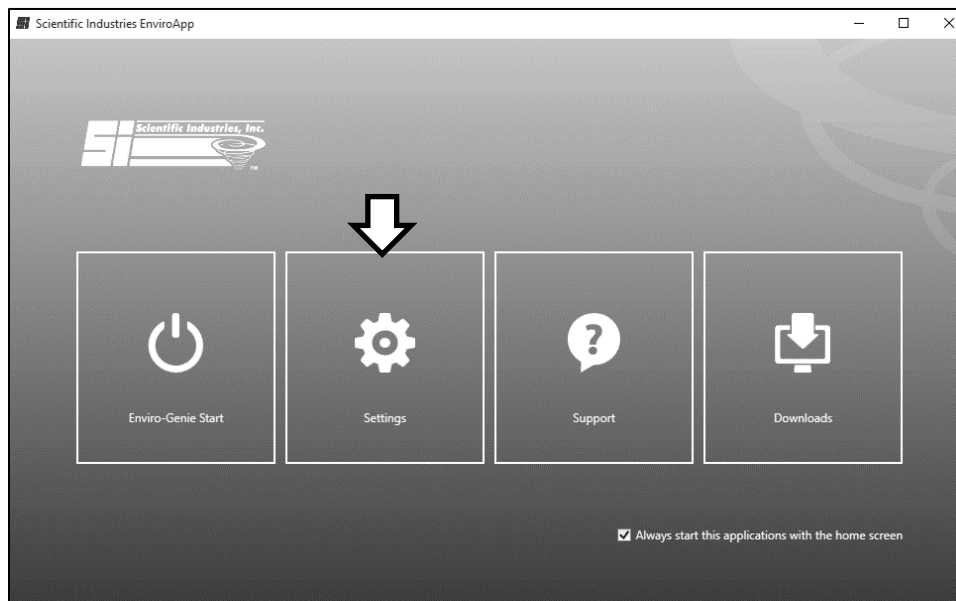

4. Select the Calibration tab and click on New Calibration.

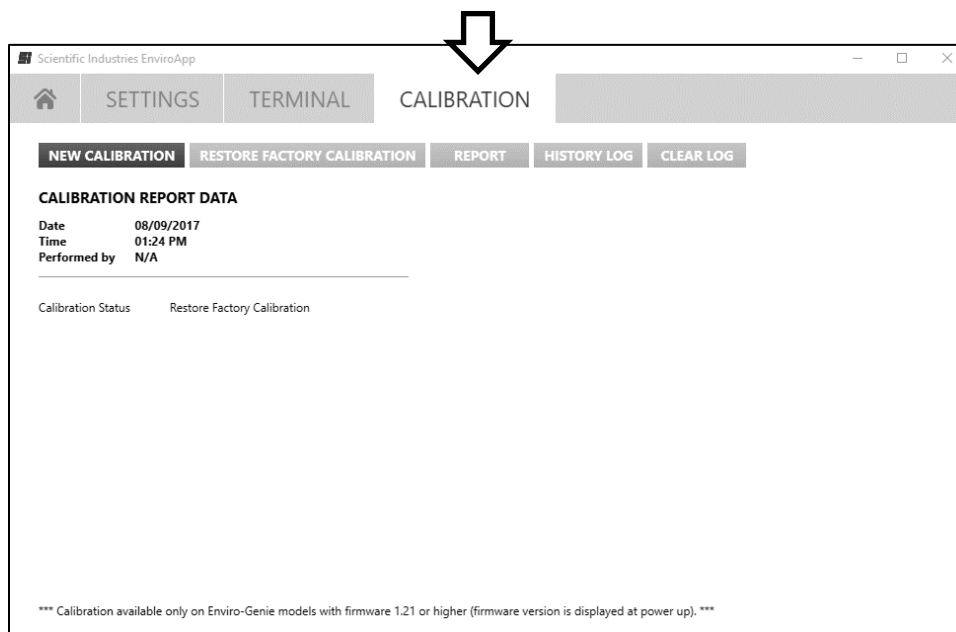

5. Wait for the Enviro-Genie incubator to start. Select the Calibration type, enter the name of the user performing the calibration, and click Next to continue.

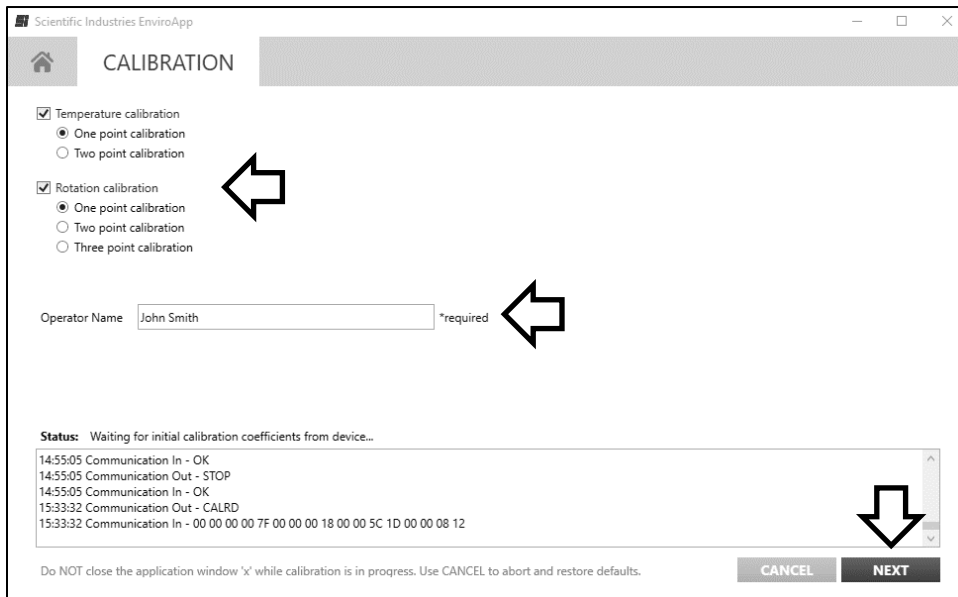

3.1. One Point Calibration

1. Enter a desired Enviro-Genie Speed Setpoint and click SET. (Low: 1 to 17 | High: 18 to 35).

One Point Rotation Calibration

Enviro-Genie Speed Setpoint **SET**

Rotation Low Speed Adjustment 92 **UP** **DOWN**

Rotation High Speed Adjustment 8 **UP** **DOWN**

2. Verify the Enviro-Genie rotation speed with an accurate reference device.

3. Adjust the speed as needed by clicking UP or DOWN, until the set speed of the Enviro-Genie is the same as indicated by the reference device

4. Click FINISH to proceed and save calibration.

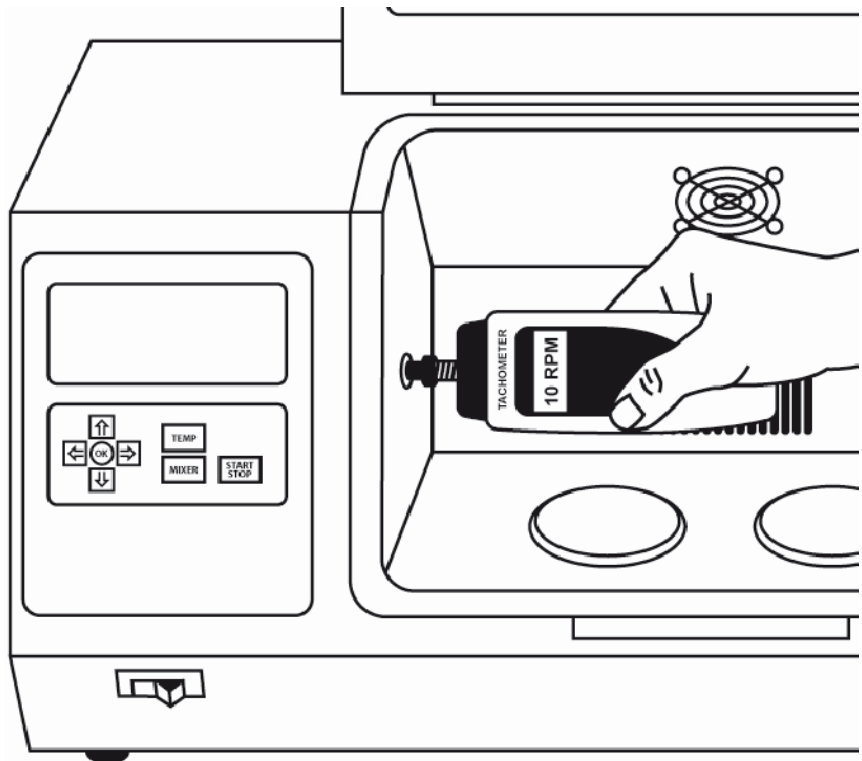

3.2. Two Point Calibration

1. Click SET to start Enviro-Genie Speed Setpoint One adjustment.
2. Verify the Enviro-Genie rotation speed 1RPM with an accurate reference device.

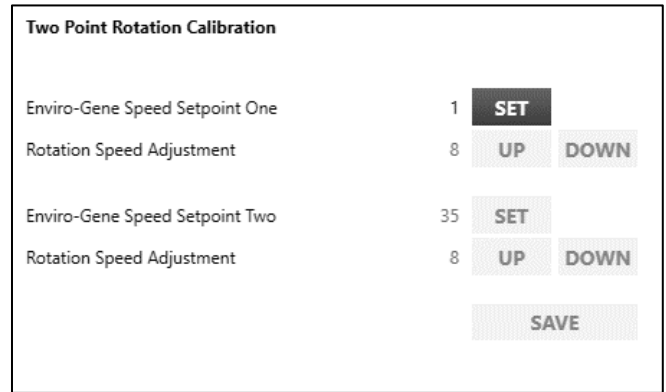

3. Adjust the speed as needed by clicking UP or DOWN, until the set speed of the Enviro-Genie is the same as indicated by the reference device.
4. Click SET to start Enviro-Genie Speed Setpoint Two adjustment.

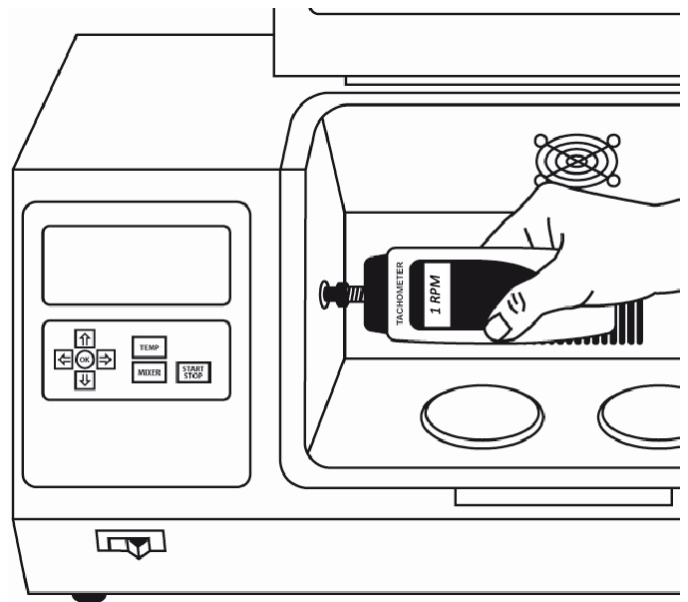

5. Verify the Enviro-Genie rotation speed 35RPM with an accurate reference device.

6. Click SAVE and then FINISH to proceed and save calibration.

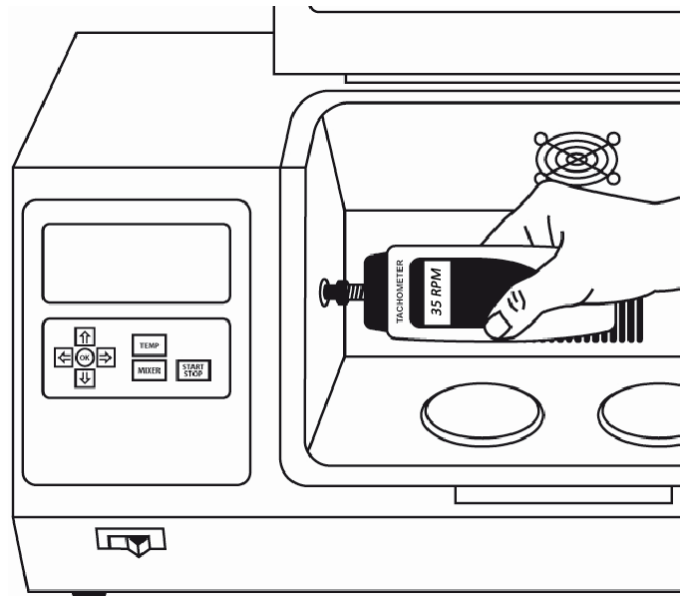

3.3. Three Point Calibration

1. Click SET to start Enviro-Genie Speed Setpoint One adjustment.
2. Verify the Enviro-Genie low rotation speed 1RPM with an accurate reference device.
3. Adjust the speed as needed by clicking UP or DOWN, until the set speed of the Enviro-Genie is the same as indicated by the reference device.
4. Click SET to start Enviro-Genie Speed Setpoint Two adjustment.
5. Verify the Enviro-Genie mid speed 18RPM with an accurate reference device.
6. Click SET to start Enviro-Genie Speed Setpoint Three adjustment.
7. Verify the Enviro-Genie high rotation speed 35RPM with an accurate reference device.
8. Click SAVE and then FINISH to proceed and save calibration.

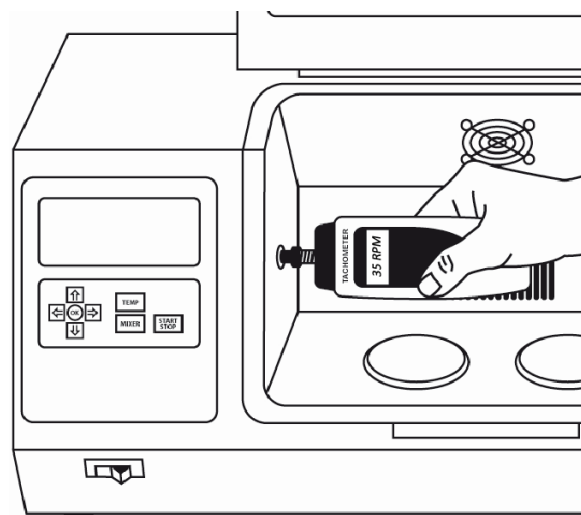
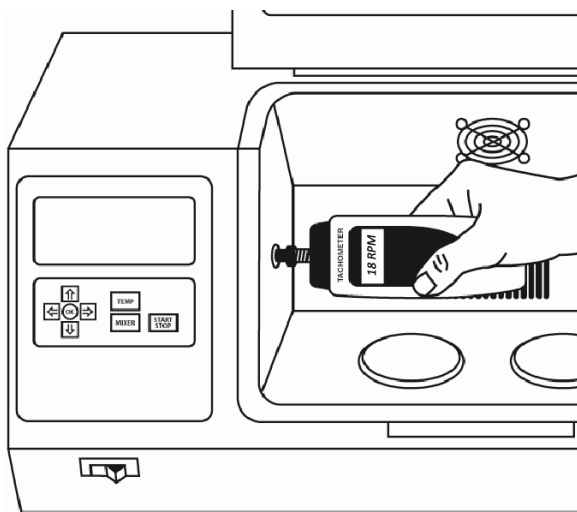
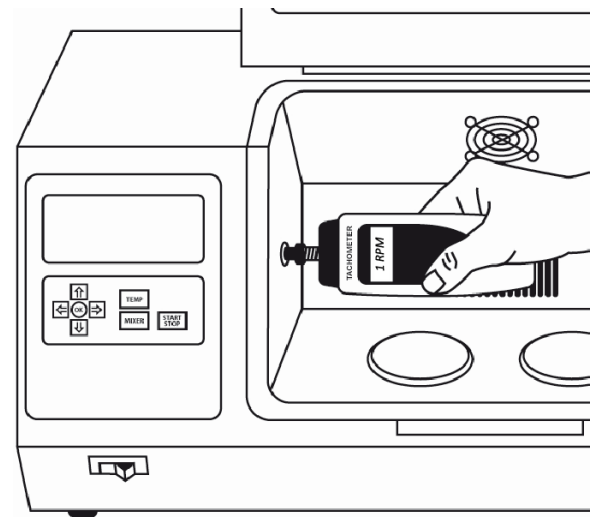
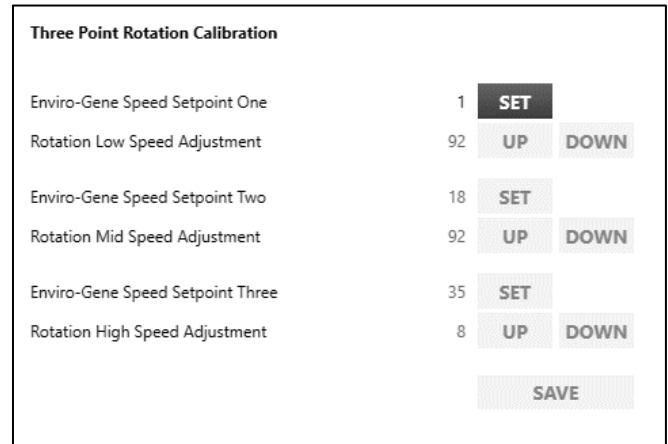

Chapter 4: Troubleshooting

Problem	Solution
Windows will not allow the EnviroApp to install.	<ul style="list-style-type: none"> • Make sure that you have administrative privileges on your PC. Contact IT support or PC administrator. • Disable your anti-virus software during the installation, or add the EnviroApp to the list of trusted applications and programs.
Drivers will not install after connecting the USB adapter.	<ul style="list-style-type: none"> • Make sure your PC is connected to the internet and your settings allow for drivers to update automatically. • Disable your anti-virus software and allow the driver to install properly.
The COM port is set but the EnviroApp cannot connect to the Enviro-Genie incubator	<ul style="list-style-type: none"> • Your PC uses several COM ports for different connections. Use the Device Manager to verify the port used by the Enviro Genie. USB adapter ports are usually labeled “Prolific USB-to-Serial Comm Port”. RS232 COM ports are labeled “Communication Port” and are usually assigned with numbers 1 through 3.
Auto Detect will not detect the COM port	<ul style="list-style-type: none"> • Auto Detect works with hardwired connections only. It may also not work with some RS232 to USB adapters. Make sure you are using an EnviroGenie approved adapter. • Use the Device Manager to verify that drivers installed correctly. • Disable the anti-virus software on your PC while performing Auto Detect
Cannot communicate via the Bluetooth adapter	<ul style="list-style-type: none"> • Verify that the wireless adapter is successfully paired with your Bluetooth PC. • Check the switch on the Bluetooth adapter and verify that it’s in the SEND position, pointing towards the antenna connector.



Scientific Industries, Inc.

80 Orville Dr. Suite 102

Bohemia, NY 11716

Tel. (631)567-4700

Fax. (631)567-5896

scientificindustries.com