

Grant bio

Laboratory centrifuge LMC-3000

Operating instructions

*For versions V.3GD
V.3GE*



Contents

1	Safety	3
2	General Information	5
3	Getting started.....	6
4	Operation of Centrifuge.....	8
5	Specifications	10
6	Guarantee and service.....	12
7	Declaration of Conformity	13







1. Safety

The following symbols mean:







Caution: Read these operating instructions fully before use and pay particular attention to sections containing this symbol

GENERAL SAFETY









-  Use only as specified in the operating instructions provided.
-  The unit should not be used if it has encountered a physical shock or has been dropped.
-  The unit must be stored and transported in a horizontal position (see package label).
-  After transport or storage allow the unit to dry out (2-3 hrs) before connecting to the mains.
-  It is necessary to observe the safety area of 300 mm around the centrifuge in accordance with EN-61010-2-20. Persons and hazardous materials must not be located in the safety area whilst the centrifuge is in operation.
-  Use only original accessories (rotors, adaptors, etc.) provided by the manufacturer and ordered specifically for this model.

ELECTRICAL SAFETY



-  Connect only to the mains with a voltage corresponding to that on the serial number label.
-  Ensure that the switch and plug are easily accessible during use.
-  Do not plug the unit into the main outlet without grounding, and do not use extension lead without grounding.
-  Before moving the unit, disconnect it from the mains. To turn off the unit, disconnect the power plug from the mains outlet.
-  It is the user's responsibility to carry out appropriate decontamination if hazardous material is spilt on or inside the equipment. If liquid is spilt inside the unit, disconnect it from the mains and have it checked by a competent person.

DURING OPERATION

-  Do not centrifuge flammable or chemically vigorously reactive materials. If such liquids are spilled in the rotor or rotor chamber the centrifuge must be cleaned with a moist cloth and a mild soap solution.

-  Do not use rotors with visible signs of corrosion, wear or mechanical damage.
-  Do not fill in the containers after they are inserted in the rotor.
-  Do not leave the operating unit unattended.
-  Do not operate the unit in environments with aggressive or explosive chemical mixtures.
-  Do not operate the unit if it is faulty or been incorrectly installed.
-  For indoor use only.
-  Do not use outside laboratory rooms.
-  Before using any cleaning or decontamination method except those recommended by the manufacturer, check with the manufacturer that the proposed method will not damage the equipment.
-  Do not make modifications to the design of the unit.

BIOLOGICAL SAFETY

-  Without bioseal the centrifuge is not a biosafety system in accordance to EN61010-2-20 and cannot be used for centrifuging hazardous materials contaminated with toxic, radioactive or pathogenic micro-organisms.
-  It is the user's responsibility to carry out appropriate decontamination if hazardous material is spilt on or inside the equipment.

2. General Information

LMC-3000 is a modern benchtop laboratory centrifuge useful for sedimentation of cells, bacteria, yeast and blood samples. It spins tubes and microtest plates. LMC-3000 is designed for safe work (metal protecting housing), easy maintenance and wide application range in medical, biochemical, industrial and other types of laboratories.

FEATURES:

- Easy set up of centrifugation parameters (time and speed) and simultaneous display of the set and actual parameter values.
- Safety: metal protective housing and metal lid, automatic imbalance switch-off, lid lock when centrifuge is running provide safe operation at all speeds.
- Rotor imbalance automatic diagnostics (emergency stop, indication "IMBALANCE").
- Low noise level.
- Soft run-up and run-down of the rotation.
- Wide choice of accessory rotors.

Centrifugation process causes moderate heating of operating chamber, which does not exceed 15°C above room temperature during an hour and a half. In cases where quickly inactivating samples are to be centrifuged the preliminary cooling or use of refrigerated centrifuge LMC-4200R is recommended.

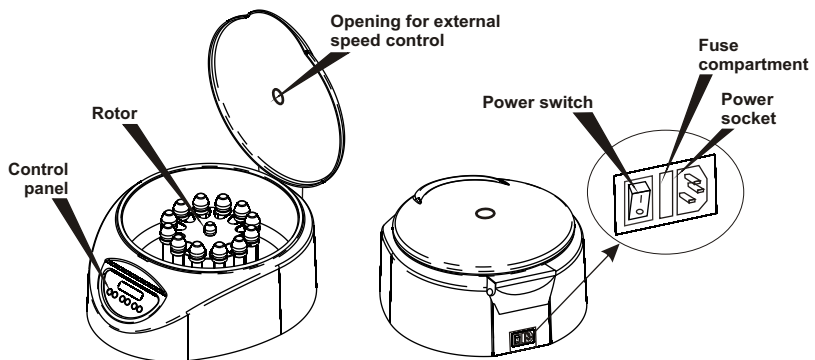

Fig.1 Overall view

3. Getting started

3.1. Unpacking

Remove packaging carefully, and retain for future shipment or storage of the unit.

3.2. The Laboratory Centrifuge LMC-3000 set includes:

Standard set

Laboratory centrifuge LMC-3000	1 pce.
A spare fuse (inside the fuse holder)	1 pce.
Power cord	1 pce.
Wrench for rotor replacement	1 pce.
Operating instructions, Declaration of Conformity	1 copy

Optional accessories

Rotor R-6 ❶	on request
Rotor R-12-10 ❷	on request
Rotor R-12-15 ❸	on request
Rotor R-2 ❹	on request
Rotor support stand RR-U ❺	on request
Adapter sets BN-13-75, BN-13-100 and BN-16-100 for R-12-10 ❻	on request

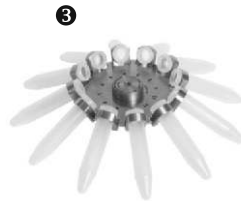
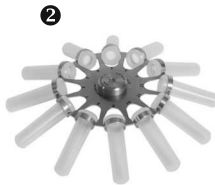

3.3. Set up:

- place the unit on an even stable and clean surface;
- plug the power cord into the socket on the rear, and position the unit so that there is easy access to the power switch and mains;
- it is necessary to observe the safety area of 300 mm around the centrifuge in accordance with EN-61010-2-20. Persons and hazardous materials must not be located in the safety area whilst the centrifuge is in operation;
- it is necessary to observe the safety area of at least 100 mm from the rear of the centrifuge.

3.4. Rotor replacement



Caution! Check the rotor and adapters for any signs of wear or corrosion and replace if necessary.

- Hold the rotor with one hand and with the help of the supplied wrench (13 mm) turn fixation nut (fig.2/1) counter-clockwise to release the rotor.



Caution! Do not hold the rotor by rings or adapters mounting when mounting and fixing it. Hold the rotor as shown on Fig. 2 (Correct).

- Replace the rotor and secure the new rotor carefully and turning the fixation nut tightly.

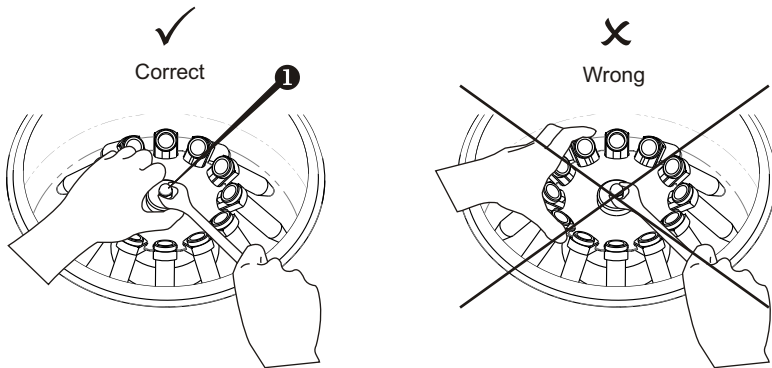

Fig.2 Rotor fixation



4. Operation of LMC-3000

Recommendations during operation

- When loading use even number of tubes arranged symmetrically (facing one another) to give the unit even balance during operation. The opposite tubes must be filled up equally.
- Centrifuge containers must not be filled over the capacity specified by the manufacturer.



Rotor must always be fixed securely. Stop the operation immediately with the **RUN/STOP** key if any unusual noise occurs during acceleration which can be due to improper rotor fixation.

- 4.1. Check the power cord for any signs of damage and replace if necessary. Connect the power cord to the mains outlet which provides a safety earth (ground) terminal. Set the power switch in position I (ON) on the rear side.
- 4.2. The centrifuge turns on and lid opens automatically.
The display shows the following readouts:
 - previously set time and speed in the upper line (**Set**);
 - mode indication (OPEN - lid opened, rotor stopped) and current speed - 0 RPM in the lower line (**Actual**).
- 4.3.  Check the rotor and buckets for any signs of wear or corrosion and replace if necessary. Insert **EVEN** number of tubes/microtest plates in rotor facing one another. The opposite tubes must be filled up equally.
- 4.4. Carefully close the lid (listen for the clicking sound of the lock) readings STOP and  (fig.3/5) in the lower line of the display indicate that the lid is closed.
Note! If any of these readings (STOP and ) has not appeared on the display centrifugation cannot be started. Try opening and closing the lid again.
- 4.5. With the “▲” and “▼” **TIME** buttons (fig. 3/①) set the required time interval (0-90 min, increment 1 min).
- 4.6. With the “▲” and “▼” **RPM** buttons (fig. 3/②) set the required speed (100-3000 RPM, increment 100 RPM). Note that the speed can also be adjusted during operation.

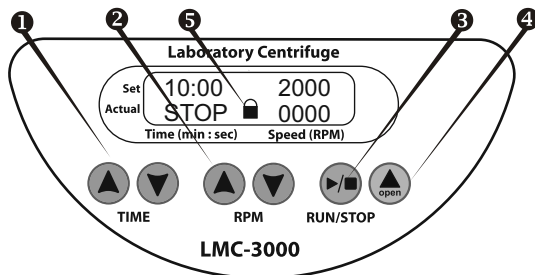

Fig.3 Control panel



Note: Some plastic tubes and microtest plates can be damaged at higher speeds. Refer to the tube material specifications to make sure that it will not get damaged at the set speed. **Do not set speed higher than 2000 RPM when working with microtest plates!**

- 4.7. Press **RUN/STOP** button (fig. 3/⑤) to start centrifugation. Blinking indication RUN and current speed is displayed in the lower line. The timer in the upper line starts countdown after the set speed is achieved (stable indication RUN).



Note: If the rotor imbalance occurs causing vibration, the centrifuge stops automatically (indication IMBALANCE). After the rotor is stopped, open the lid and remedy the cause of imbalance.

- 4.8. Centrifugation is stopped automatically after the set time elapses while display shows blinking indication STOP. A sound signal is emitted after full stop of the rotor (press **RUN/STOP** button (fig.3/⑤) to stop the signal).
- 4.9. If necessary centrifugation can be stopped before the set time elapses by pressing **RUN/STOP** button. The set time interval will be shown on the display.
- 4.10. Press the button **Open** (fig.3/④) and open the lid lifting it upwards with a hand (it is possible to open the lid only when the rotor is stopped). Display shows OPEN.
- 4.11. At the end of operation set the **Power** switch in position O (OFF) on the rear.
- 4.12. Disconnect the power cord from the mains outlet.



Note: The electrical lid lock allows opening the lid only when the unit is connected to the mains and is turned on. Do not force the lid to open when the unit is switched off!

Lid emergency opening

- Disconnect the power cord from the mains outlet and allow the centrifugation to stop.
- Slide the unit to the front of the bench to access the emergency opening slot on the underside of the unit (located in the front side).
- Avoid tilting the unit as this may cause spilling of the materials from the containers inside the unit.
- Insert a small screwdriver (or similar tool with diameter up to 3 mm) into the emergency opening slot in front of the dot on the label "Open" at a depth of 10-15 mm.
- Move the lever from the left to the right hand side to release the lid lock.

5. Specifications

The product is designed for operation indoors in a laboratory at altitudes up to 2000 m, with ambient temperature from +4°C to +40°C and maximum relative humidity 80% for temperatures up to 31°C decreasing linearly to 50% relative humidity at 40°C.

- Speed setting range100 - 3000 RPM (increment 100 RPM)
100 - 2000 RPM using the rotor R-2
- Digital time setting1 - 90 min (increment - 1 min)
- Acceleration time up max. speed, not more35 sec
- Slowdown time, not more35 sec
- Rotor imbalance automatic diagnostics (emergency stop, indication "IMBALANCE")
- Rotation directioncounterclockwise
- DisplayLCD
- Maximum noise level, not more65 dB
- Working diameter335 mm
- Dimensions 495x410x235 mm
- Operating voltage/ power consumption 230 V, 50 Hz / 110 W (0.5 A)
or 120 V, 50/60 Hz / 120 W (1 A)
- Weight, not more 13 kg

Optional accessories	Number of places	Characteristics	Speed range, rpm	RCF
Rotor R-6	6	50 ml	0-3000	1700 x g
Rotor R-12-15	12	15 ml	0-3000	1700 x g
Rotor R-12-10	12	10 -15 ml	0-3000	1700 x g
Rotor R-2	2	96, 48, 16, 4 well plates	0-2000	560 x g
RR-U	Description: Rotor holder			
Optional adapter set (12 pcs)	For rotor	Description	Tube dimensions, ø x length	
BN-17-120 (standard)	R-12-15	For 15 ml tubes	17 x 120 mm	
BN-16-90 (standard)	R-12-10	For 10 - 15 ml tubes	16 x 105 mm	
BN-13-75	R-12-10	For vacutainers 2-5 ml	13 x 75 mm	
BN-13-100	R-12-10	For vacutainers 4-8 ml	13 x 100 mm	
BN-16-100	R-12-10	For vacutainers 8-9 ml	16 x 100 mm	

Optional accessories	Description	Manufacturer	Dimensions, ø x length (max.)
Rotor R-6	Centrifuge tube with cap, conical bottom	Greiner bio-one, Sarstead, Corning, Nunc	29 x 115 mm
Rotor R-12-15	Centrifuge tube with cap, conical bottom	Greiner bio-one, Sarstead, Corning, Nunc	17 x 120 mm
Rotor R-12-10	Centrifuge tube without cap, round bottom	Greiner bio-one, Sarstead, Corning, Nunc	16 x 105 mm
Rotor R-2	Standard 96-well microtiter plates or other plates	Greiner bio-one, Sarstead, Corning, Nunc	128 x 85.6 x 45 mm (WxDxH)

Grant is committed to a continuous programme of improvement, specifications may be changed without notice.

6. Guarantee and service

6.1. Guarantee

When used in laboratory conditions and according to these working instructions, this product is guaranteed for TWO YEARS (exclude items mentioned in Table below) against faulty materials or workmanship.

Additional items
BN-16-90 standard adapter set for R-12-10
BN-17-120 standard adapter set for R-12-15
BN-13-75 adapter set for R-12-10
BN-13-100 adapter set for R-12-10
BN-16-100 adapter set for R-12-10
Rotor holder RR-U

6.2. Service & Maintenance

There are no user-serviceable parts inside the unit. For all maintenance and repairs (except as defined below) return to our service department in the UK or in other countries, our distributor.

6.3. Cleaning & Disinfection

Cleaning liquids that do not contain concentrate organic solvents, alkali or acid can be used for device cleaning. It is recommended to perform disinfection after operation session by cleaning the parts inside the centrifuge chamber. Rotors and other accessories are not autoclavable.

Standard ethanol (75%) or other cleaning agents recommended for cleaning of laboratory equipment can be used for cleaning and disinfection of the unit.

6.4. Replacement of fuses (fig.4)

Disconnect from the outlet.

Remove the power plug from the rear of the unit. Pull out the fuse holder by applying leverage in recess (A). Remove the fuse from the holder. Check and replace with the correct fuse if necessary (for 230V - T1A or for 120V - T2A).

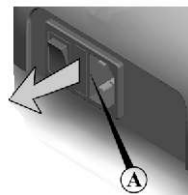

Fig.4 Fuse holder

6.5. Routine safety tests

If routine tests are to be made, we recommend a test of the integrity of the protective earth conductor and an insulation test at 500 Vdc. Routine flash tests are not recommended for any electrical equipment, because repeated high voltage tests degrade insulation materials.

Declaration of Conformity

Equipment name:	LMC-3000
Type of equipment:	Laboratory centrifuge
Directive:	EMC Directive 2004/108/EC Low Voltage Directive 2006/95/EC
Manufacturer:	SIA BIOSAN Ratsupites 7, build.2, Riga, LV-1067, Latvia
Applied Standards:	EN 61326-1: Electrical equipment for measurement, control and laboratory use EMC requirements. General requirements EN 61010-1: Safety requirements for electrical equipment for measurement, control and laboratory use. General requirements EN 61010-2-20: Particular requirements for laboratory centrifuges

We declare that this product conforms to the requirements of the above Directive(s)

Signature
Svetlana Bankovska
Managing director

Signature
Aleksandr Shevchik
Engineer of R&D

15.10.2012
Date

15.10.2012
Date

Grant bio

**Grant Instruments
(Cambridge) Ltd**

Shepreth
Cambridgeshire
SG8 6GB
UK

Tel: +44 (0) 1763 260811

Fax: +44 (0) 1763 262410

Email: scientificsales@grantinstruments.com

www.grantinstruments.com