

**Thermo Scientific
SPIN TISSUE PROCESSOR
Microm STP-120**

INSTRUCTION MANUAL

SPIN TISSUE PROCESSOR

Model STP-120



INSTRUCTION MANUAL

Version 2.30
English
04/2011

Contents

Safety Precautions.....

- Warning symbols.....
- Intended use and safety precautions.....
- Certification.....
- Warranty.....

Technical characteristics.....

Reception and emplacement.....

- Transport and unpacking.....
- Emplacement.....
- Connection.....

Control panel.....

Programming.....

- Basket cycle.....
- Example of a process.....
- Entering the program.....
- Starting the program.....
- Delayed start.....
- Stopping the program.....
- End of the program.....
- Temperature display.....
- End of process display.....

Setup Menu.....

- Changing the language.....
- Changing the date and time.....
- Working with two baskets.....
- Power failure.....
- Emergency Movements.....

Maintenance.....

- Cleaning.....
- Changing the filter.....
- Replacing the battery.....
- Alarms.....
- Resetting the unit.....
- Reagents.....
- Technical Service Centres.....

Safety precautions

These instructions should be read carefully and fully understood before installing and operating the unit.

Warning symbols

This manual uses the following symbols:



DANGER:

Special warning messages to prevent harm to persons and/or serious damage to equipment. For your own safety, please observe these instructions carefully.



CAUTION, WARNING:

Special precautionary measures to prevent damage to equipment. For a long lifetime of the equipment, please observe these instructions carefully.

NOTE:

- *Special instructions regarding operation of the instrument.*

BIOHAZARD:

Warning of biological danger.



Intended use and safety precautions

Dear valued Customer,

Thank you for buying this instrument.

Before putting the instrument into operation, please read these operating instructions carefully to familiarize yourself with its proper operation and function. Non-compliance with these instructions means that you are invalidating the standards of safety and use for which this instrument was designed.

The STP 120 is an efficient spin tissue processor with carousel system for embedding specimens in paraffin.

Only skilled or specially trained personnel must operate the instrument. The listed and marked safety measures as well as the regulations and hygiene measures of your respective lab must strictly be observed.

Ser. No.....

Please enter the serical number, which is placed on the type plate on the rear side of the instrument. This way, questions and service can be handled faster.

Operating instruction no.: 387718

Issued on April 18th, 2011

Microm International GmbH part of Thermo Fisher Scientific Otto-Hahn-Str. 1A 69190 Walldorf Germany Phone: +49.(0)6227.836-0 Fax: +49.(0)6227.836-111 Email: info.dxd.dewal@thermofisher.com Internet: www.thermoscientific.com

**\$ DANGER:
INSTRUMENT GROUNDING**

To avoid injury from electrical current, the instrument must be connected with the safety ground. The instrument is equipped with a three wire ground plug. The power outlet must be connected to the safety ground and must meet the International Electrotechnical Commission (IEC) regulations.

**\$ DANGER:
MAINS VOLTAGE**

Do not remove the covers from the instrument during operation. Any replacement or adjustment of components should only be carried out by authorised trained maintenance staff. Disconnect the unit from the mains power supply before opening or removing any covers.

**\$ DANGER:
RISK IN EXPLOSIVE ENVIRONMENT**

The instrument must not be operated in the presence of flammable gases.

**\$ DANGER:
RISK OF RADIOACTIVE RADIATION**

When working with radioactive specimens, all procedures applicable to protection against radiation should be observed.

**\$ DANGER:
RISK OF INFECTION**

Use appropriate safety and disinfection measures when working with infectious specimens.

**\$ DANGER:
HAZARD OF MALFUNCTION**

To avoid the hazard of malfunction of an instrument, it must only be operated in a controlled electromagnetic environment. This means that transmitters such as mobile phones must not be operated in their close vicinity.



HAZARD OF BIOLOGICAL DANGER

Specimens used during the intended operation of the instrument might potentially be infectious. For this reason, it is recommended to observe the general laboratory regulations concerning protection against danger of infection. Information on decontamination media, their use, dilution and effective range of application can be read in the Laboratory Biosafety Manual : 1984 of the World Health Organization.

When working with radioactive contaminated material, appropriate safety and disinfection measures must be carried out. According to the rules and regulations concerning the handling of radioactive contaminated material of the respective laboratory, safety clothing (e.g. particle mask, gloves, protective shoe covers) must be worn.



Separate taking back of electrical and electronic instruments in the countries of the European Union:

This is to be applied in countries of the European Union and other European countries with a separate collecting system within the waste management.

This product, being an electro and/or electronic instrument, must be treated separately within the waste management process (WEEE).

Certification

Thermo Fisher Scientific Microm International GmbH certifies that this instrument has been tested and checked carefully. Its technical data was verified before shipment to be in accordance with the published specifications. The instrument complies with applicable international safety regulations.



Warranty

This Thermo Scientific product is warranted against defects in material and workmanship for a period of 1 year. Parts which prove to be defective during the warranty period will be repaired or replaced free of charge by Thermo Fisher Scientific Microm International GmbH. No other warranty is expressed or implied. Unauthorized modification or repair by third party persons will void the warranty.

The warranty will expire in case of improper or wrong use of the instrument and in case the warning and precautionary messages are not observed. Thermo Fisher Scientific Microm International GmbH is not liable for any occurring damage.

Once the guarantee period has expired, a maintenance contract should be signed to ensure the unit is kept in optimum operating condition.

For more information about maintenance contracts, please contact your local distributor.

Although every effort is made to ensure that the characteristics and information contained in this manual are correct, undetected printing errors are beyond the manufacturer's control and so no responsibility can be accepted.

This manual is subject to modifications and changes without previous notification.

This instruction manual will be supplied together with each instrument. Further copies can be ordered at the nearest sales office by giving the serial number of the instrument, the number of the instruction manual and the date of issue.

	Cat. no.
German	387717
English	387718
Spanish	387720
French	387719

Technical characteristics

Type STP-120	
EC Directives	Refer to notes on next page
Applicable Standards	
Electromagnetic compatibility	
Sizes	
Diameter of the carousel	850 mm
Height	500 – 700 mm
Diameter of the turning circle	670 mm
Weight	
Including packing	145 kg
Net (fully equipped)	70 kg
Electrical installation	
Rated Voltage ($\pm 10\%$)	100...120 V 1.7 A 50...60 Hz
	220...240 V 0.9 A 50...60 Hz
Fuses	115 V (2 x T4AH) 230 V (2 x T2AH)
Battery	Nickel-Cadmium (12V 600 mA)
Overvoltage category	2
Pollution degree	II
Sound pressure	< 70 dBA
Capacity	
Reagent stations	
Number of reagent vessels	10 (9, if 3 are for paraffin.)
Volume per reagent vessel	1.8 L
Baskets for the specimen holders	
Number of baskets	1 (option of 2)
Basket capacity	120 specimen holders
Paraffin stations	
Number	2 (option of 3)
Volume	1.8 L
Rated Voltage	24 V ~
Rated power per station	100 VA
Temperature range	50 – 70 °C
Hysteresis margin	0.1 – 2 °C
Temperature cut-off	80 °C (± 4 °C)
Thermal protection	Manual reset

Programming	
Number of programs	10 (selectable)
Programmable infiltration time per station	from 1 s to 99 h 59 m
Rotation stirring	selectable
Vertical shake	selectable
Centrifugation	selectable
Centrifugation time	selectable
Program start delay	selectable without time limit
Environmental conditions	
at a max. rel. humidity of	60% without condensation
Temperatures	from + 5 to + 40 °C
Storage temperature range	from -20 °C to +50°C
Altitude	up to 2000 m M.S.L.
Floor loading requirements	160,0 kg /m ²
For indoor use only	

Reception and emplacement

Transport and unpacking

During transport the carousel should always be kept in an upright position.

Your carousel SPIN TISSUE PROCESSOR has been fully tested and has undergone rigorous processes of verification and control before being packed. Open the packing carefully and make sure that the machine has not suffered any damage during transport. If any damage is observed, immediately report this fact to the distributor and the company insuring the transport.

Remove any support or brace holding the machine inside the packing box.

&

CAUTION:

Two people are required to remove the carousel from the packing box. Take care to always hold the carousel as shown in the figure.

Never lift the processor by the upper cover of the carousel as this will cause irreparable damage to the unit!

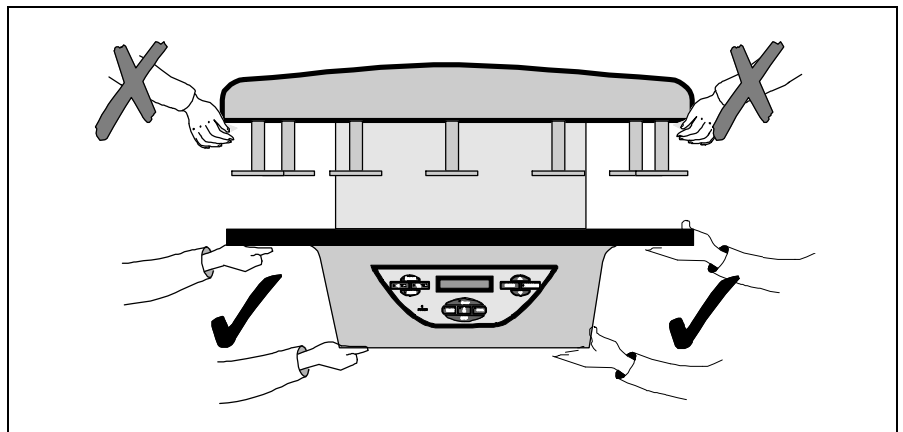

Emplacement

Choose a suitable flat surface measuring at least 900 mm in width x 900 mm depth and with **750 mm of headroom**.



CAUTION:

During operation, the cover of the processor is raised about 200 mm above its rest position.

It is absolutely necessary that the emplacement of the processor has at least 750 mm of free headroom otherwise the carrousel will be irreparably damaged when it opens.

Make sure that:

- n the surface is perfectly smooth, flat and stable.
- n the site is well ventilated.
- n there is sufficient surrounding space to allow easy access while safely supporting the weight of the machine (Refer to sizes and weights in the section on characteristics).



WARNING::

When selecting the emplacement for the machine, remember that the Main ON/OFF switch is located at the rear and that it **must be accessible** at all times.

Manual rotation of the whole unit:

Apart from the automatic rotating system for the processor cover, the base of the unit is also fitted with wheels. This enables the whole unit to be turned by hand to enable easy access to all the reagent vessels and paraffin baths should it be placed close against a wall.



CAUTION

Never turn the unit holding it by the cover.

Before turning the unit, hold it by the reagent vessel support table and proceed as follows:

- n use the € button, to raise the carrousel cover to its uppermost position.
- n turn off the unit at the Main ON/OFF switch and unplug the power supply cable (see next page). This will enable the unit to be turned on its axis without any risk of damaging the power cable.

Connection

The electronic unit of the carousel is suitably protected and adequately shielded according to EC Standards on emission and reception of interference. Nevertheless, the unit should not be installed close to other high power equipment that could generate vibrations or strong electrical interference.

The carousel is supplied with a power cable for connection to a standard outlet with earth. The electrical connection is located at the rear.



CAUTION:

Before connecting the power cable, make sure that the machine is adjusted to operate at the supply voltage.

The factory settings for the power supply are for operation with 220-240 V ~. If the unit is operated with 100 – 120 V~, open the cover of the power plug, remove the fuse holder and invert its position so that the visor shows 115 V the correct operating voltage. The fuses should also be replaced by others corresponding to rated value as indicated in the table below.

	1	Insert a screwdriver here to open the cover of the power plug and invert the fuse-holder with the voltage selector
	2	Window showing the operating voltage (in the example 220V)
	3	On/Off switch. Pressing: I = start O = stop (the image shows the stop position)
	4	Standard power plug with earth connection.
Values of the fuses depending on the operating voltage	110-120 V - 4 A (2 x T4AH)	
	220-240 V - 2 A (2 x T2AH)	

Initial turn-on

Before assembling the baths, start the unit to raise the carousel.



DANGER:

Never attempt to turn, raise or lower the carousel cover by hand or force it in any way!

Apart from the risk of personal injury, the machine could suffer irreparable damage. Always use the keys on the control panel to make any manual movements and keep hands away from any moving parts.

Connect the power supply cable and start the unit using the stop-start switch located at the rear of the unit, above the plug for the power supply cable.

When the power is connected the unit automatically begins a machine test cycle and the fume exhaust fan will be operating.

**SPIN TISSUE
PROCESSOR V1.XX**

This message appears on the display (V1.XX indicates the software version).

This is followed by:

FILTER CHANGE XXXX HOURS (Refer to 'Changing the filter), and then:

C10 C11 C12
16° 16° 16°

indicating the temperature of the paraffin baths.

NOTE:

- *These messages may appear in a language other than your own. If you want to change the language now, refer to section Changing the language.*

Furthermore, the date and time perhaps do not coincide with those in your country. If you want to adjust the time, refer to chapter Changing the date and time.

READY **01/01
12:50**

The display indicates (in the pre-set language), a message like the one shown here.

Press the € button once. Note that the carousel opens to a half-way position and the basket holder begins to turn.

TAKE SAMPLE
C 011

When the carousel stops opening, press the € key once again to continue opening the basket holder as far as possible. The screen will display the message indicating 'Take sample' and the reagent vessel located at 'C01'.

If the basket holder is not physically in the position of reagent vessel 1, press the key • repeatedly to advance the basket to the position of reagent vessel No 1. Disconnect the unit from the power supply.

Now you can place the reagent vessels and paraffin baths in position.

Connect the paraffin baths.



CAUTION

*Before connecting or disconnecting the paraffin baths, make sure that the unit is **disconnected from the power supply** by turning off the main switch located at the rear of the unit.*

Now you can turn the unit on again.

Main parts of the spin tissue processor

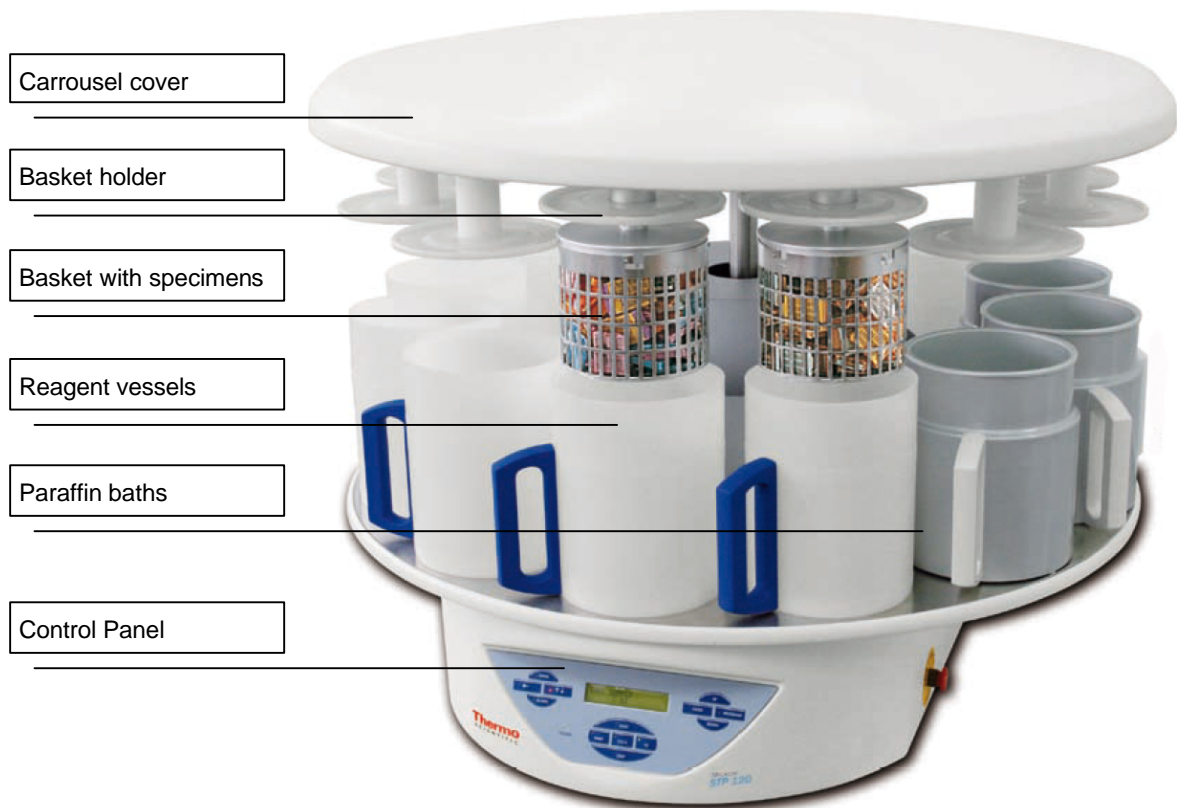

! *The model shown in the figure corresponds to the version with two basket holders, three paraffin baths and glass reagent vessels. Depending on the processor model, the reagent vessels may be either glass or aluminium:*

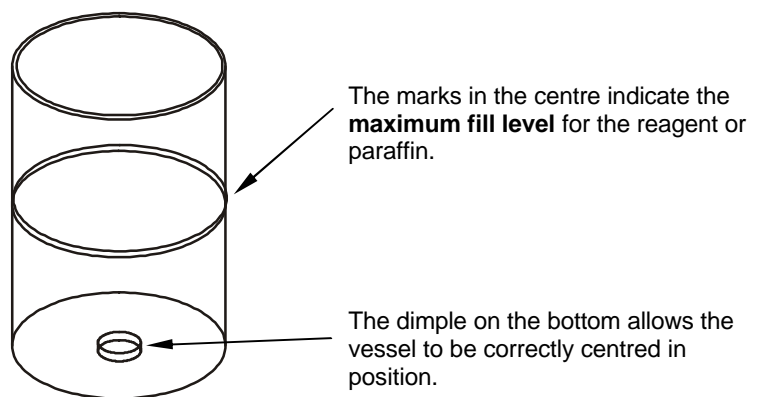

DANGER:
Under no circumstances should the maximum fill level be exceeded as the process will not be performed correctly and reagent or paraffin could be spilled.

Connection of the paraffin baths

The paraffin baths are connected from the rear of the unit.

For easier access to the rear part of the apparatus, the whole unit can be turned on itself.

Do not turn the unit holding it by the carousel cover. Refer to instructions and precautions to be taken when turning the unit by hand.

CAUTION



*Before connecting or disconnecting the paraffin baths, make sure that the unit is **disconnected from the power supply** by turning off the main switch located at the rear of the unit.*

CAUTION:



Always use the following connections:



- n the connection marked with the number 10 **only if a third paraffin bath has been installed in position 10**
- n the connection marked with the number 11 only if the paraffin bath has been installed in position 11
- n the connection marked with the number 12 only if the paraffin bath has been installed in position 12

Note the **grooves** in the edge of the processor table to allow connection of the cables to the paraffin baths.

Placement of the baskets



The baskets are held in position by a **four point** bayonet connector.

When fitting the baskets, make sure that the four studs fit into the four grooves on the edge; turn the basket as far as possible inside the groove and allow it to rest on the pivots of the basket holder (see figure).

Before beginning to process tissues, you should become familiar with the handling and programming of the machine. Design a small test program and perform some manual movements without any reagents in the vessels or samples in the baskets.

Control panel

The control panel at the front of the carousel contains all the keys required to handle and program the carousel. The keyboard is of the membrane type. Activate the keys by pressing in the centre of the corresponding icon or indicator. Do not use sharp objects as they could damage the membrane and the keyboard.

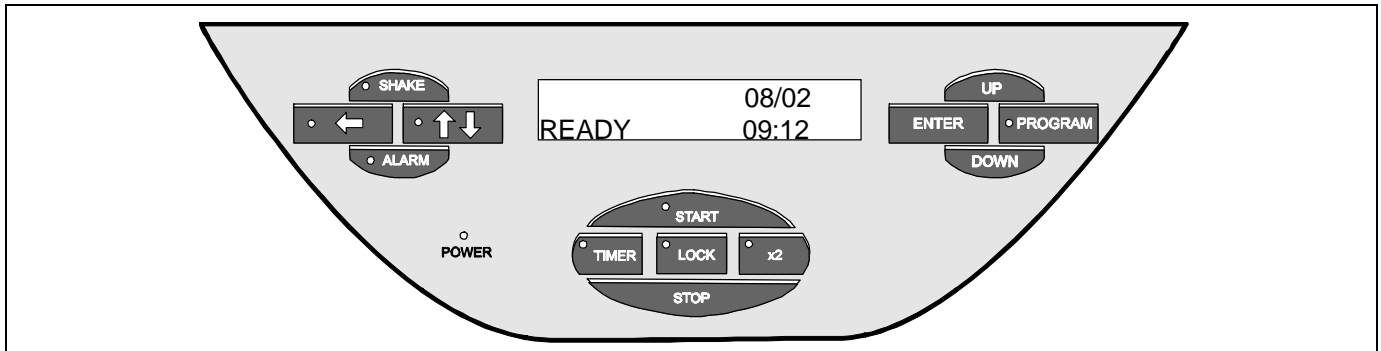

The actions of the keys:

SHAKE

Vertical shake. Pressing this key lights the indicator light and activates the **SHAKE** function. This function enables vertical shaking of there basket during the stirring process (refer to Basket cycle).

- Press this key to make the machine perform a partial rotation, moving the basket holder to the next station. This is only possible when the basket holder is in the upper position.

- € This key raises and lowers the basket holder as required. If it is pressed when the basket holder is moving, it will reverse the direction. The **STOP** key stops all movement

POWER

The LED lights up to indicate that the unit is connected to the power supply.
A flashing LED indicates that the unit is operating on the emergency battery (for more information refer to section Power failure)

START

Key to start the automatic operating cycle (program). When the unit is operating in automatic mode, the pilot beside the key is lit.

STOP

Key to stop the automatic operating cycle. If this key is pressed the microprocessor asks for confirmation of whether the process is to be aborted. Once the stop is confirmed, the program is cancelled and the machine must be controlled in manual mode using the keys € and • to place the basket holder above the first reagent vessel. The **STOP** key also halts any movement of the machine at any time.

TIMER

Allows delaying the start. Refer to Delayed start. When the **TIMER** is active the display appears as dimmed the pilot light of the key is lit

LOCK

Pressing this key blocks all the keys on the control panel (to prevent accidental operation). Restore the key actions by holding down this key for more than two seconds.

x2

This key should always be pressed when the machine is fitted with a double basket holder (optional accessory). For more information, refer to section Working with two baskets

UP

When adjusting values it increases the value displayed, or goes back to the previous option

DOWN

When adjusting values it decreases the value displayed, or goes to the next option.

PROGRAM

Use this key to access the mode for editing programs or making adjustments.

ENTER

Validates the option or adjustments made.
For more information, refer to Programming

CAUTION

● *Before executing the first real process with reagents and paraffin, remember that paraffin can sometimes take a long time to melt. After a long period of disconnection (for example the first start or after power failure), the basket will not descend into the paraffin bath (even though this is programmed) until the default safety period has elapsed.*

When testing the programming, skip paraffin bath positions 11 and 12 (and 10 if working with two baskets) by assigning them a time period of 00:00.

WAITING FOR PARAFFIN
Po 1• C XX• TR=00:00

If you program a time period of more than 00:00 in positions 11 and 12 (10, if working with three paraffin baths), the screen will display this message, where XX is the number of the reagent vessel programmed prior to paraffin bath 11 (10 if a third bath is installed).

Programming

The SPIN TISSUE PROCESSOR offers a wide range of possibilities for programming processes of fixing and dehydrating histological samples with reagents and then infiltrating them with paraffin.

The control system enables up to 10 different processes to be programmed (programs 01 to 10).

Before beginning to enter programs, it is a good idea to become familiar with the cycle of the carousel. Pay close attention to the cycle performed by the basket at each of the 12 reagent vessels.

Basket cycle

The figure below shows the movements of the basket and the different phases that it goes through. The text describes these movements and the times that can be adjusted.

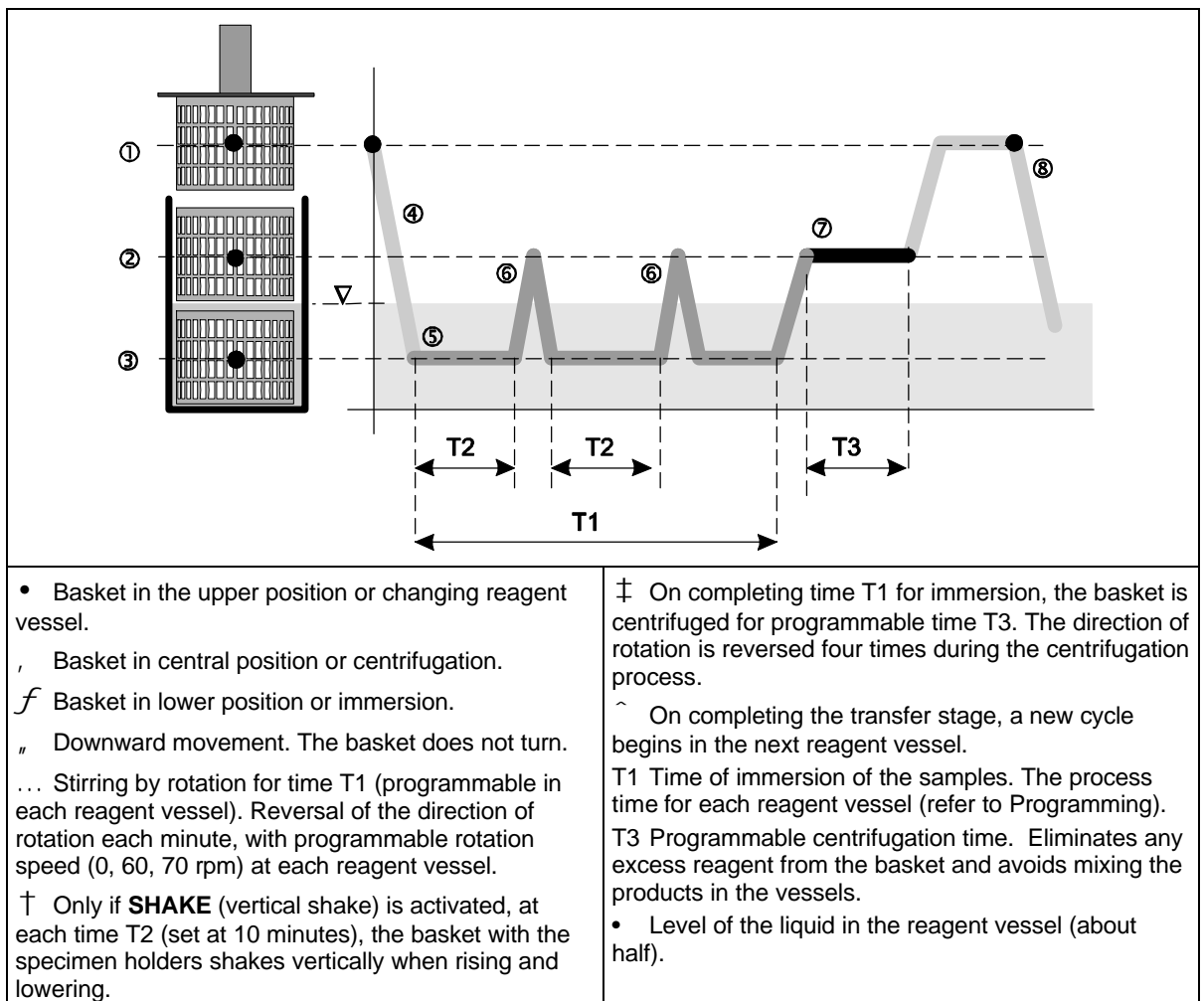

Example of a process

Suppose that we want to program a process that fulfils the following specifications:

Reagent vessel No.	Reagent	Immersion Time Hours : Minutes	Stirring rate	
			rpm.	Programmed value
1	Formol	01:00	60	1
2	Formol	01:00	60	1
3	Alcohol 70%	01:30	70	2
4	Alcohol 80%	01:30	70	2
5	Alcohol 96%	01:30	70	2
6	Alcohol 100%	01:00	70	2
7	Alcohol 100%	01:00	70	2
8	Alcohol 100%	01:00	70	2
9	Xylol	01:30	70	2
10	Xylol	01:30	60	1
11	Paraffin	02:00	60	1
12	Paraffin	02:00	60	1

The 'programmed value' is a digit that appears on the programming display. It has the following meaning:

- 0 = without rotation stirring
- 1 = rotation stirring at 60 rpm.
- 2 = rotation stirring at 70 rpm

In cases 1 and 2, the direction of rotation of the motor is reversed every 60 seconds.

Entering the program

Enter the program when the machine is connected to the power supply and in the stop position. Make sure that:

- n the vessels contain the reagents indicated on the list.
- n the basket holder is located at station 1 (if not, raise the carousel by pressing the € key and advance by repeatedly pressing the • key until it is located in position 1). Press the € key to lower the basket holder into reagent vessel 1 and prevent the reagents from evaporating while carrying out the programming.

DANGER

- **The paraffin baths may reach high temperatures. Take precautions to avoid burns.**

In this situation the screen displays the following message:

READY	01/01 12:34
-------	----------------

If the date and time hour or language of the display are not correct, they should first be adjusted.
Refer to Changing the language and Changing the date and time.
If the date, time hour and language are correct, proceed as follows.

Press the **PROGRAM** key and then the **ENTER** key.
The pilot light of the **PROGRAM** key will light and the screen will display the following message:

SELECT PROGRAM	P 01
----------------	------

Note that '01' is flashing. This means that, of the 10 programs available in the unit, program number 01 is to be used. Program several different processes by selecting a different number for each of them using the **UP** or **DOWN** keys.

If program No 01 is selected the screen will appear as shown below:

P 01	HH:MM	A
C 01	00:00	0

P 01 indicates that program number 01 is being edited.
C 01 indicates that the values are being assigned to reagent vessel 01.

HH:MM is the time the samples remain in reagent vessel 01, expressed in Hours and Minutes

A Is the stirring rate:
0 no stirring
1 stirring at 60 rpm
2 stirring at 70 rpm.

Pulse **ENTER** to assign the values to reagent vessel 01.

Use the **UP** or **DOWN** keys to increase or reduce the value and **ENTER** to confirm the value and go to the next option.

If a reagent vessel is assigned a time of 00:00, the carousel will not immerse the basket in the corresponding reagent.

The option of vertical shake is common to all the vessels and is activated by the **SHAKE** key, when starting program (refer to 'Starting the program').

If the SPIN TISSUE PROCESSOR is fitted with a second basket holder for operation in double capacity mode (two baskets), refer to section Working with two baskets.

Once the times and stirring rate have been programmed for each reagent vessel, press **PROGRAM** to exit program edit mode.

Before executing the program for the first time, verify that the default values (factory settings) or those modified using the edit menu, are suitable for the process to be performed:

- n Temperature of the paraffin baths. Default value: 62 °C.
- n Frequency of the vertical shake (only if this option is activated by pressing the **SHAKE** key when starting the program). Default value: every 10 minutes.

- n Centrifugation time, before the change of reagent vessel.
Default value: 60 seconds

Starting the program

Make sure that each reagent vessel contains the appropriate reagent coinciding with the selected program:

CAUTION

- *The vessels should not be filled to more than the **marks etched at half their height**, otherwise the centrifugation process, apart from not having the required effect of not mixing reagents, could cause mechanical damage to the unit.*

If the SPIN TISSUE PROCESSOR is fitted with a second basket holder, refer to section Working with two baskets.

Proceed as follows:

- 1 Raise the basket holder by pressing the € key.
- 2 Place the basket with the specimen holders in the basket holder. Make sure that the bayonet lock closes correctly.
- 3 Press **STOP** to exit manual operating mode
- 4 **Only** if vertical shake is required, press the **SHAKE** key. The key indicator lights up.
- 5 **Only** if working with a double basket, press the **x2** key. The pilot beside the key will light
- 6 Press the **START** key to begin the program. The display suggests executing program P 01
- 7 If a program other than 01 is to be used, press the **UP** or **DOWN** keys to modify the option.
- 8 Start the program immediately by pressing **START** again. The program will begin to execute.
- 9 **Only** if the start of the program is to be **delayed** so that it **finishes** at a certain date and time, press the **TIMER** key. The screen will display the following message

SELECT?	15/08
P 01•	08:20

Delayed start

PROGRAM END	
16/08/01	08:00

Depending on the times specified in the program for each reagent vessel, the microprocessor calculates and displays the date and time when the program will **finish**. If the program is to finish **later** than the time indicated on the display, the date and time values can be altered using the **UP** and **DOWN** keys and confirmed by pressing **ENTER**. If by error the value entered is less than that suggested by the microprocessor, the original value will be restored (immediate execution of the program).

PROGRAM START
16/08/01 08:00

Press **START**. The **TIMER** pilot light will flash. The display is dimmed showing the date and time at which the program will **start**.

Stopping the program

Press the **STOP** key to halt:

- n the current program if it is running
- n the delay start timer, if programmed.

In each case, the microprocessor asks for confirmation of the operation with the message:

DO YOU REALLY WANT TO STOP THE PROCESS?

(or the **TIMER** if it is activated).

Press **START** and the process will continue or the **TIMER** will continue its down count.

Press **STOP** again and the process will be interrupted.

If the process is stopped use the € key to raise the basket holder and remove the basket with the specimen holders. If necessary, use the • key to move the basket holder to the position of reagent vessel 1. Otherwise, when a new basket holder is loaded and **START** pressed to begin a program immediately, the carousel will automatically move to reagent vessel 1 before beginning the process.

End of the program

Under normal operating conditions, the program will stop in paraffin bath 12, and issue a warning beep every five seconds. If the program being run was P 01, the screen will display the following message.

END OF PROGRAM
P 01

Press the **STOP** key to stop the program.

Then press the € key to raise the basket holder and remove the basket with the infiltrated samples.

DANGER

- *The paraffin may be very hot. Take adequate precautions to avoid burns.*

NOTE:

- *Start a new process **immediately** by placing the new basket in the basket holder and pressing **START** to begin processing. The carousel automatically moves to reagent vessel 1 to begin the process.*

If the next process is to use the delay start **TIMER**, or the SPIN TISSUE PROCESSOR is not going to be used until the next day, the basket holder should be moved to reagent vessel 1 using the • key and lowered with the € key to prevent the reagents from evaporating.

Temperature display

C10	C11	C12
55°C	54°C	57°C

The temperature of the paraffin baths can be consulted at any time during the process by pressing the **DOWN** key.

The screen will display the temperatures of each of the vessels for a period of 3 seconds.

End of process display

PROGRAM END		
P 01	06/10/01	09:23

The expected time for completing the process can be consulted at any time by pressing the **UP** key.

The screen displays the expected date and time for completion of the process for a period of 3 seconds.

Setup Menu

For more detailed information on how to enter a program, refer to chapter Entering the program.

The **SETUP MENU** can only be accessed if the carousel is in the stop position and no program is being run. Press the **STOP** key. If the pilot light of the **LOCK** key is on the keyboard is blocked. Press the **LOCK** key to extinguish the pilot light located beside it.

If the language has been correctly configured (refer to Changing the language and Changing the date and time). The screen will display the following message.

READY	05/02 10:50
--------------	------------------------------

The table below summarises the use of the keyboard in the **SETUP MENU**:

Key	Action	
PROGRAM	Enter EDIT PROGRAM mode. Press the UP or DOWN key to access the SETUP MENU	
Key	When the text displayed ...	
	Does not flash	Flashes
UP	Access to higher levels	Increases the value displayed
DOWN	Access to lower levels	Decreases the value displayed
ENTER	Access to the next lower level of the same option.	Confirms the value entered
PROGRAM	Exits the SETUP MENU . Values not confirmed by pressing ENTER are not changed	

The **SETUP MENU** includes the following options and levels:

SETUP MENU	Options	Comments
1. LANGUAGE		Changes the language used to display messages
1.1 CASTELLANO	Y/N (YES/NO)	Selects Spanish as the language
1.2 ENGLISH	Y/N (YES/NO)	Selects English as the language
1.3 FRANCAISE	Y/N (YES/NO)	Selects French as the language
1.4 ITALIANO	Y/N (YES/NO)	Selects Italian as the language
1.5 DEUTSCH	Y/N (YES/NO)	Selects German as the language
2. UNITS TEMP.		Enables the user to define the temperature units
2.1 TEMPERATURES IN	Celsius/Fahrenheit	
3. CLOCK		Adjustment of local date and time
3.1 DAY	00 to 31	
3.2 MONTH	00 to 12	
3.3 YEAR	2000 to 2999	
3.4 HOUR	00 to 24	
3.5 MINUTE	00 to 59	
4. FILTER		Enables the values associated with the filter to be queried and adjusted.
4.1 FILTER TIME	0001 to 9999	Theoretical hours of filter service life (according to the manufacturer)
4.2 CHANGE FILTER	0001 to 9999	Remaining hours of life since the last change (Reset)
4.3 FILTER RESET		Caution: Confirm by pressing ENTER , only after really changing the filter
5. PARAF. TEMP		
5.1 PARAF. TEMP. 10	from 50 to 70 °C	Allows adjustments to be made to the temperature of the paraffin baths
5.2 PARAF. TEMP. 11		
5.3 PARAF. TEMP. 12		
6. TIMERS		Allows adjustments to be made to the centrifugation times and the frequency of the vertical shake.
6.1 CENTRIFUGATION	000 to 180 s	Centrifugation time in seconds before the change of reagent vessel
6.2 VERTICAL SHAKE	0600 to 3000	Frequency for performing the vertical shake (if the ' SHAKE ' key is activated)

Two examples of modification of the Setup are shown below:
Changing the language and changing the date and time

Changing the language

The carousel display can be configured to display messages in five different languages:

Castellano, English, Français, Italiano, Deutsch

Step 1: Press the **PROGRAM** key. If the currently configured language is English, this message appears:

EDIT PROGRAM

Step 2: Press the **DOWN** key to go to the next option. The following menu appears:

SETUP MENU

Step 3: Press **ENTER** to confirm access to the **SETUP MENU**.

SETUP MENU
1. LANGUAGE

Step 4: Press **ENTER** again to access the language option. The **UP** or **DOWN** keys then allow access to other Setup options:

2. Temperature Units
3. Clock
4. Filter
5. Paraffin temperature
6. Timers

1.1 CASTELLANO
• Y

Step 5: Press **ENTER** to display the first option (1.1 Castellano). Press the **DOWN** key until the desired language appears. When it appears, press **ENTER**. The screen will display a flashing N (No). Press **UP** to change it to a Y (Yes). Press **ENTER** again to confirm the option.

Changing the date and time

Access the **SETUP MENU** as indicated for changing the language until Step 5.

SETUP MENU
3. CLOCK

Press the **DOWN** key until option 3 appears on the screen. Clock.

Press **ENTER** to select the option to change the date and time. Each time the **DOWN** key is pressed the display will advance from the day to the minute in the following order:

- 3.1 Day
- 3.2 Month
- 3.3 Year
- 3.4 Hour
- 3.5 Minute

Use the **UP** key to move backwards from Minute to Day.

3.4 HOUR

•

10

When the screen displays the value to be changed, (in this example, the hour) press **ENTER** to access the value (which will begin flashing) and then use the **UP** and **DOWN** keys to make appropriate changes. Once correctly adjusted, press **ENTER** to confirm the value and go to the next option.

Working with two baskets

As an optional extra, the SPIN TISSUE PROCESSOR may be fitted with a second basket holder to double its processing capacity.

When the unit is fitted with two baskets the following points should be taken into consideration:

- n When starting the process, the additional basket (which is located over reagent vessel 2), will not be able to perform the process of reagent vessel 1 (unless this first process is performed manually by the operator).
- n Irrespective of the times programmed for each reagent vessel (even if the programmed value is 00:00), the processing time will be the same for all the vessels and will be the value assigned to the first reagent vessel.
- n On finalising the process, the original basket (not the additional one), will be located above reagent vessel 11 and will not undergo the process of reagent vessel 12 (unless this is final process is performed manually by the operator).
This situation can be corrected by installing a third paraffin bath.

CAUTION

- ***When working with two baskets remember to press the 'x2' key before starting the program with the START key (this will light the indicator located beside the 'x2' key). Otherwise, the second basket (optional) will be erroneously submerged in the reagent in reagent vessel 1 when the carousel moves to position 12.***

Power failure

A very important feature of the SPIN TISSUE PROCESSOR is its capacity to react in the event of a power supply failure.

The unit is fitted with an emergency **backup battery** to enable the process to continue uninterrupted or to allow manual operation to remove, if necessary, the basket with the specimen holders (refer to 'Emergency Movements'.)

NOTE:

- ***The backup battery is designed to continue controlling the process times and enable completion of all the movements that have been started. That is, to leave the carousel in the submerged position in the reagent and, eventually, enable the carousel to be moved manually using the € and • keys.***

Whenever a power failure occurs, the green pilot light beside the POWER indicator begins to **flash**. If the carousel is performing the movement of changing vessels, the microprocessor will automatically complete the movement and leave the basket holder in the corresponding vessel, without performing any of the operations of stirring or heating of the paraffin baths, but controlling the time period elapsed.

When the power supply is returned, the process will continue from this point.

The temperature of the paraffin baths is not maintained during battery operation. When the power supply is returned, the process will continue from this point. The temperature of the paraffin is not maintained during battery operation. After a power loss of more than 7 minutes, the paraffin may be solidified and any basket movement/transfer is inoperable. An automatic remelt timer is started which disables any basket movements for the next four hours. The screen shows the message: "Waiting for paraffin". The normal process will be automatically continued after a power resumption for at least four hours and the paraffin is surely melted.

WAITING FOR PARAFFIN		
P 01	C 10	TR=00:00

The re-melt timer is a protection device against mechanical damage of the transportation/lift device. The re-melt timer may be reset to enable immediate access to the cassettes, as soon as the user assures himself of the fact that the paraffin is in liquid condition and mechanical blockages are avoided.

Depending on the software version two individual buttons have to be pushed at the same time. The actual software of your device is indicated for 4 seconds every time the unit is turned on. Valid for all software versions: By pushing the button **DOWN** the display must show the actual paraffin temperatures. This display is shown only for about 3 seconds. Only when the paraffin temperature display is active you may reset the remelt timer by pushing the two buttons (Button 1 and Button 2) at the same time according following list.

Version	Release date	Button 1	Button 2
V. 1.3	Sept. 01 st , 2001	ALARM	X2
V. 1.41	Dec. 12 th , 2001	ALARM	SHAKE
V. 1.41	June 06 th , 2002	TIMER	ENTER
V. 1.43	Sept. 25 th , 2003	TIMER	ENTER
V. 2.0	Nov. 06 th , 2003	TIMER	↑↓

A beep sound indicates the reset of the remelt timer. Lifting or lowering the basket via button ↑↓ is possible now to enable access to the cassettes.

Emergency Movements

If it is necessary to raise the basket holder or move the carousel during a power failure, turn the key switch located above the input plug of the power supply cable:

- n give it a quarter turn in a clockwise direction,
- n hold the key in this position for two seconds,
- n return it to the vertical position.

The green pilot light beside the POWER indicator will flash to indicate that the unit (except the paraffin baths) is being operated by the emergency battery power supply.

Under these circumstances it is possible to move the basket holder with the € and • keys to extract it should it be necessary to abort the process.

Once the specimen holder basket is removed, the carousel should be lowered again with the € key to close the reagent vessels. Press the **STOP** key to cancel the process that has been aborted. After a certain period of time without any key being pressed, the machine will turn itself off.

CAUTION

- *Remember that if the switch at the rear of the unit has not been turned off, when the power supply is restored the carousel will start automatically (with the program aborted) and immediately begin heating the paraffin baths.*

Maintenance

Lubrication:

Every six months, raise the cover of the carousel using the € key to its uppermost position and lubricate it **exclusively with the grease** supplied by the manufacturer.

Changing the filter:

Refer to instructions on changing the filter

Inspection:

The spin tissue processor should be revised by a manufacturer authorised technician at least once a year.

Cleaning

The processor should be cleaned every day just like any other piece of laboratory equipment. Any spilt reagent should be eliminated immediately as prolonged contact with the surfaces of the unit could cause damage or stains.



CAUTION:

Before cleaning the processor, raise the cover using the € key and then turn off the power supply at the Main ON/OFF switch.

DANGER:

- ***When performing any maintenance or cleaning operations always bear in mind that the reagents used may be highly inflammable and that the paraffin baths may reach extremely high temperatures.***

- n Do not use reagents that contain acetone or xylol or any abrasive powders.
- n Always clean the unit with domestic detergents without any abrasive additives.
- n Use a plastic spatula to remove any remains of solid paraffin. Do not use sharp objects that could scratch the surface.
- n The reagent vessels (not the paraffin baths) may be cleaned in a conventional dishwasher.
- n The paraffin baths may be disconnected from their bases for easier cleaning.

CAUTION:

- ***When replacing the paraffin baths, make sure that each one is connected to the corresponding power plug.***
- n During cleaning, make sure that no detergent liquid enters the electrical connections and power plugs.
- n When cleaning the carousel cover, use extreme care not to force it in any way.



WARNING:

Before using any cleaning or decontamination method or product

other than those recommended, obtain confirmation from the manufacturer that these methods or products are not going to damage the unit in any way.

Changing the filter

CHANGE FILTER
0400 HOURS

As an optional extra, the unit may be supplied with a double activated charcoal filter to neutralise any fumes given off by the reagents used. The system controls the life of the filter in hours. When starting the unit the following message is displayed:

The value displayed (in the example 400 hours) is the time remaining for the filter to complete its service life. The filter should be changed when this counter displays 0000 HOURS.

Change the filter by removing the rear cover and proceeding as shown in the figure below.

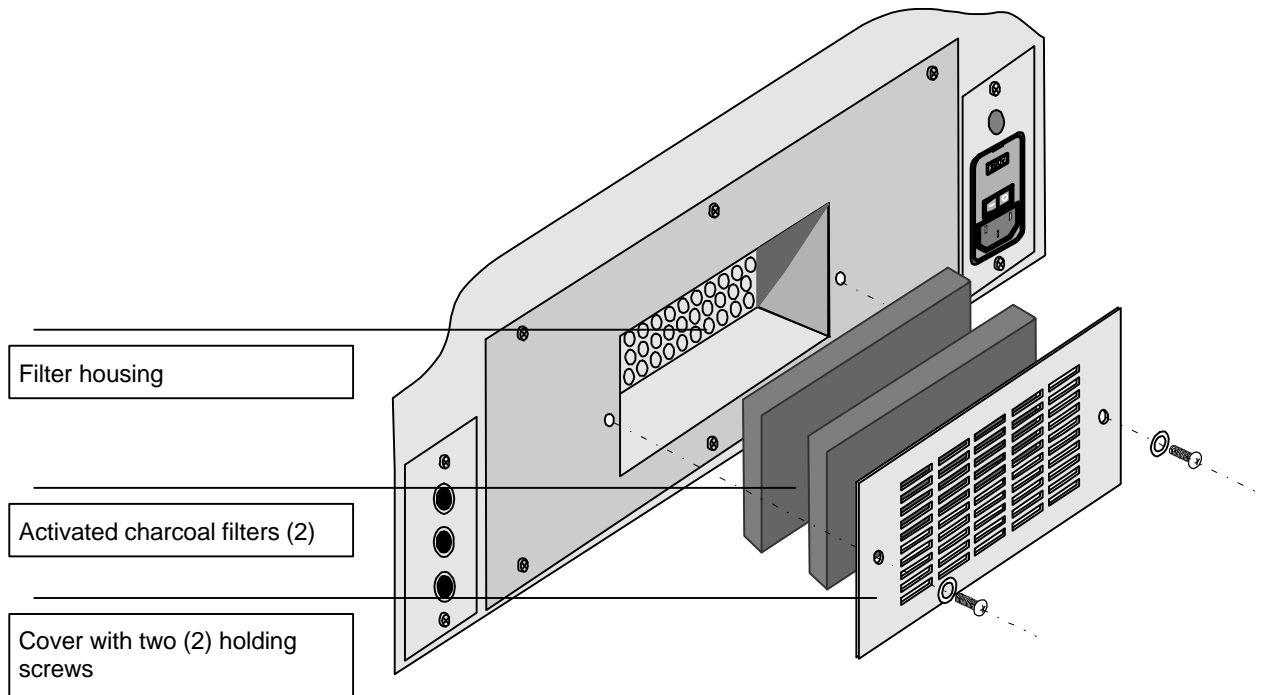

After changing the filter the working life counter should be reset to the original value. Access option 4.3 of the Setup Menu **FILTER RESET** and press **ENTER** to reset the counter.

Replacing the battery

Under normal operating conditions the battery has a very long service life.

If the alarm message "Check Battery" appears repeatedly, (for example after a long period of inactivity) the machine should be connected to the power supply for several hours to allow the battery to charge itself.

If the battery does not recharge and the alarm message does not disappear, the battery should be replaced with a new one.

Change the battery by accessing the rear part of the unit and proceeding as shown in the figure:

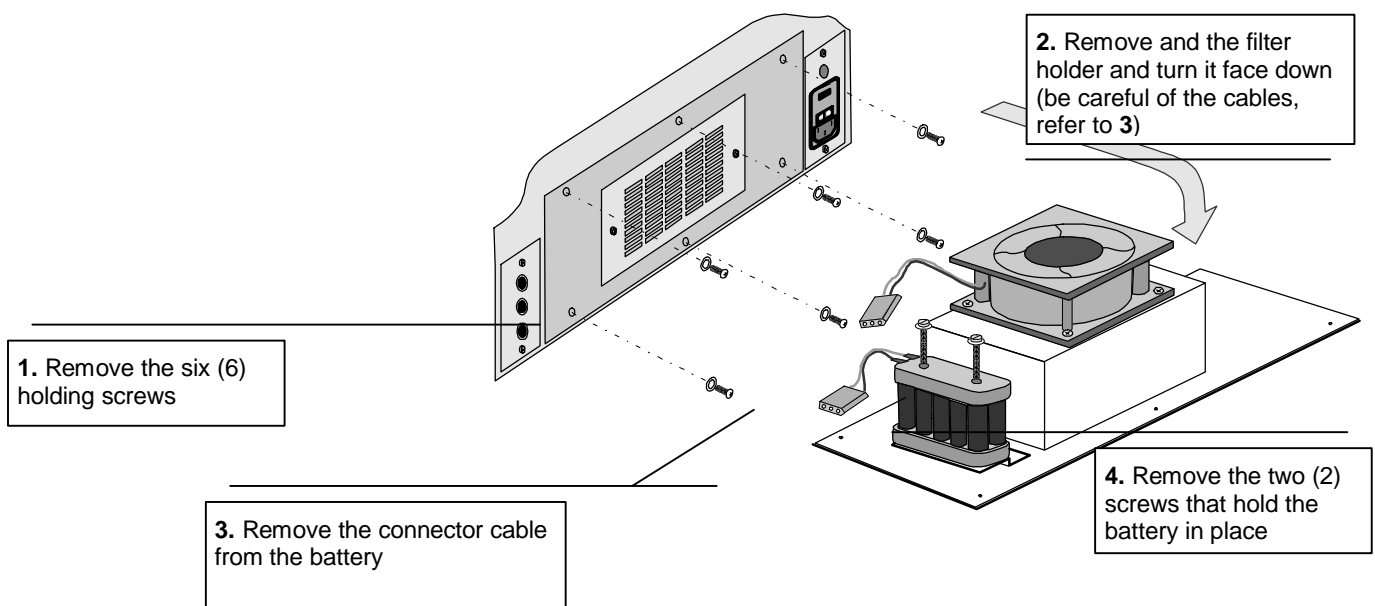

Place the new battery in position and reassemble the unit by proceeding in the reverse order.

Alarms

Should any instrument failure occur, the microprocessor displays an alarm message on the screen and the pilot light of the **ALARM** key begins flashing.

There are two types of alarm:

- n alarms that can be resolved by the user
- n alarms that must be resolved by an authorised service technician

Alarms that can be resolved by the user:

Alarm	Cause	Solution
SOLID PARAFFIN	The unit is attempting a vertical movement over a paraffin bath where the paraffin has not melted	Wait until the paraffin has melted.
POWER FAILURE	The power supply to the unit has failed and therefore the basket may have been at one station for longer than programmed and finalisation of the program may be delayed	Determine whether the whole process should be repeated
PROBE FAILURE 10 1112	The unit has lost contact with the probe that measures the temperature of the indicated station.	Make sure that the paraffin bath is connected to the correct connector. Refer to 'connecting paraffin baths'
CHANGE FILTER	The working life of the filter has expired	Refer to 'Changing the filter'.
SAMPLES OUT	An attempt is being made to program a delayed start with the carousel not lowered.	Place the carousel in the start position (basket submerged in reagent vessel 1)
	In Take Sample the time limit for the samples out of the liquid has been exceeded	Lower the carousel to submerge the basket in the reagent vessel.
CHECK BATTERY	Low battery level has been detected on starting the unit	Make sure that the battery is connected and that the fuse has not blown.

Acknowledge an alarm by pressing the **ALARM** key. If the alarm does not disappear or reproduces itself frequently, notify a service technician.

Alarms that should be resolved by an authorised Service Technician

HOLDER LOWERED
 HOLDER IN CENTRE
 HOLDER RAISED
 VERTICAL FAILURE
 HORIZONTAL FAILURE
 HORIZONTAL MOTOR ON
 REGULATOR FAILURE
 HOLDER OUT OF RANGE
 UNIT FAILURE

The last page of this manual includes the address of the Technical Service Centre closest to you.

Resetting the unit

Proceed as described below to delete all the programs and restore the unit with the factory settings:

- n turn off the unit using the main ON/OFF switch
- n hold down the **ALARM** key and turn the unit on using the main switch, hold the key down for two seconds.
- n release the **ALARM** key

NOTE

- ***This operation deletes all the programs in the unit and restores the default factory settings***

After this operation the basket holder must be moved using the € keys and the carousel moved to position 1 using the • key.

Refer to section Entering the program, to create new processing programs.

Reagents

The SPIN TISSUE PROCESSOR may be used with the reagents that are shown in the list below.

Fixing	Formalin, buffered or unbuffered
	Trinitrophenol
Dehydration	Industrial alcohol
	Ethyl alcohol
	Isopropyl alcohol
	Butyl alcohol
	Methanol
Purification	Xylene and substitutes
	Trichlorethane
	Benzene
	Toluene
	Acetone
Infiltration	Paraffin

The use of other reagents not indicated in the list is not recommended.

**Technical Service
Centres**

In Spain:

Thermo Fisher Scientific LABORGERATE, S.L.
Avda. San Ramón Nonato, 33
E-08028 BARCELONA (Spain)
Tel. [34] 934 480 388
Fax. [34] 933 346 150

In France:

Thermo Fisher Scientific FRANCE
Parc du Chater
33, Rue Bellisen
F-69349 Francheville (France)
Tel. [33] 478 342 167
Fax. [33] 478 341 239

Other countries of the world:

Microm International GmbH
part of Thermo Fisher Scientific
Otto-Hahn-Str. 1A
69190 Walldorf
Germany
Phone: +49.(0)6227.836-0
Fax: +49.(0)6227.836-111
Email: info.dxd.dewal@thermofisher.com
Internet: www.thermoscientific.com

Caution:

Any shipping of the instrument requires original packaging materials! Damages caused by shipping with non-conform packaging are not covered by the manufacturer warranty! Any damage repairs resulting in non-conforming package are fully charged to the sending party. We reserve the right depending on seriousness of damage NOT to repair.

To order original packaging materials, please contact Thermo Fisher Scientific or your local, by Thermo Scientific authorized, dealer.

Caution:

The user must care for a clean and safe condition of the instrument when returning it to an appropriate service provider.

Note:

If the original packaging is no longer available, please contact your local Thermo Scientific representation.

Disposal of the instrument after final shutdown



After the final shutdown of the instrument we recommend to contact a local recycling company for the disposal according to the national applicable regulations.

To be applied in the countries of the European Union and other European countries with a separate collecting system within the waste management.

The marking of the product and/or the respective literature indicates that, after its final shutdown, it must not be disposed of together with ordinary domestic waste.

Please dispose of your instrument separately from other waste to not harm our environment and/or human health by uncontrolled waste disposal.

Recycle your instrument to support the sustainable recycling of material resources.

Industrial users should contact their suppliers and observe the conditions of the contract. This product must not be disposed of together with other commercial waste.

Please contact your supplier!!!

Service setup

This section describes the adjustments that only can be carried out by an Authorised Technical Service Centre.

CAUTION

- **These values should not be modified by the operator or user as other operating values of there processor could be affected. These modifications should only be made by trained technicians from an Authorised Service Centre.**

Access the Technical Service Setup menu by successively pressing the keys **STOP**, **ALARM** and **TIMER** within a maximum interval of 1 second.

1. TEMPERATURE MENU	Options	Default value	Comments
1.1 HYSTERESIS	0.1 to 2	0.1 °C	Establishes the connection/disconnection range above and below the assigned temperature
1.2 MAX. TEMPERATURE	50 to 70	70 °C	Temperature limits that can be selected by the user from the SETUP MENU
1.3 MIN. TEMPERATURE	50 to 70	50 °C	
1.4 PARAF. ACTIVE WITH TIMER	Y/N	Y	Enables keeping the paraffin baths hot during delayed start.
2. FAN			(refer to the diagram below)
2.1 OPERATING TIME	0000 to 9999	180	Time in seconds that the fan is connected when starting the processor
2.2 ON TIME	0000 to 9999	120	Time that the fan is operating
2.3 OFF TIME	0000 to 9999	600	Pause between fan operating periods
3. MOTOR STEP BY STEP			
3.1 STIRING RATE 1	005 to 250	080	Speed in rpm for stirring 1
3.2 STIRING RATE 2	005 to 250	080	Speed in rpm for stirring 2
3.3 CENTRIFUGE SPEED	005 to 250	180	Speed en rpm for the centrifugation
4. OPTIONS			
4.1 SHAKE ENABLE	Y/N	Y	Enables or disables the option of activating vertical SHAKE

Diagram showing fan operation

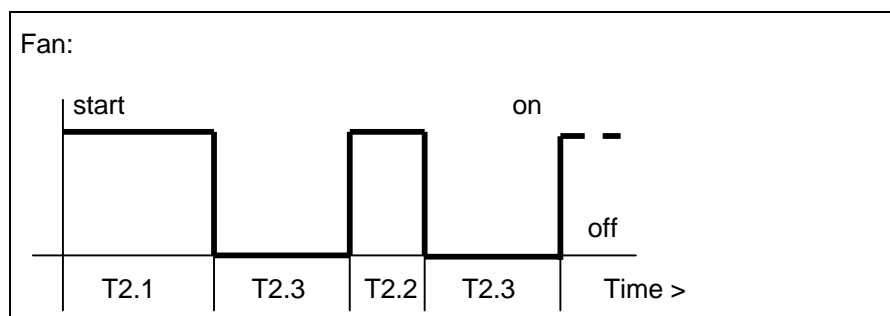

SPIN TISSUE PROCESSOR		
Program Record Sheet		
Program number (01 to 10):		Comments:
Written by:		
Date:		

Reagent vessel	Reagent	Time (HH:MM)	Stirring (0/1/2)	Notes
1				
2				
3				
4				
5				
6				
7				
8				
9				
10				
11	Paraffin			
12	Paraffin			

Comments: