

# IKA

designed for scientists

## IKA RC 5 control



Operating instructions

EN

## Device setup

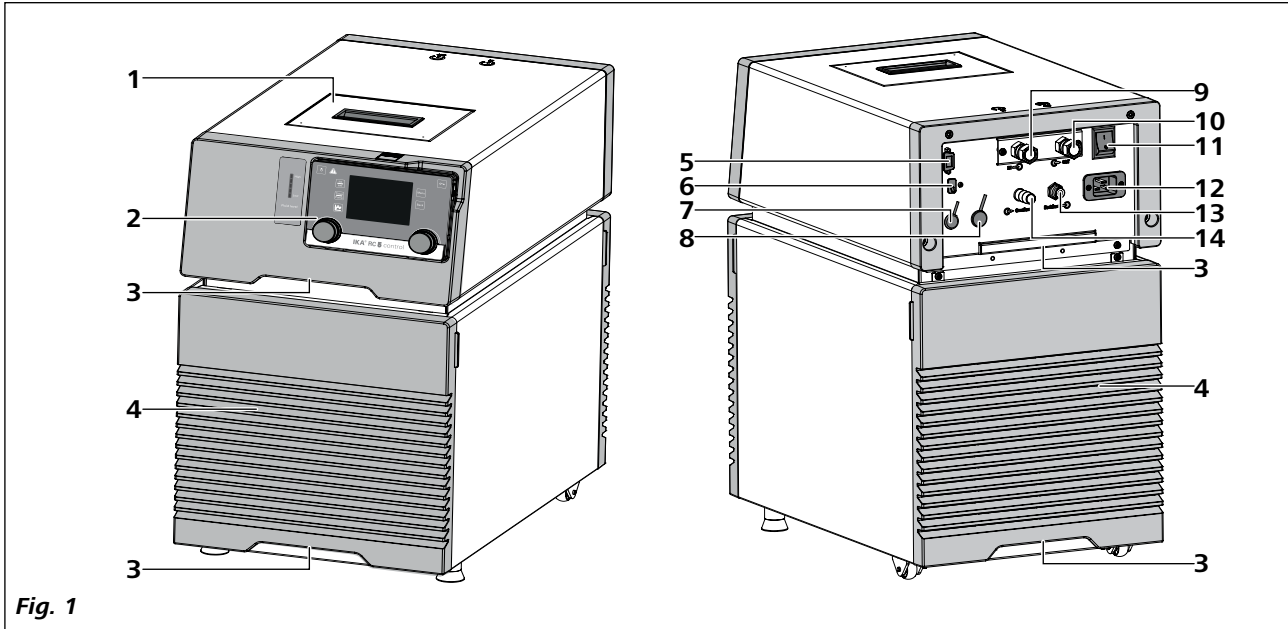

Fig. 1

Item	Designation
1	Filling opening lid
2	<b>Wireless Controller (WiCo)</b>
3	Handle
4	Venting grid
5	RS 232 port
6	USB port
7	External temperature sensor socket
8	Multifunction port
9	Pump connector <b>IN</b>
10	Pump connector <b>OUT</b>
11	Power switch
12	Power socket
13	<b>Backflow</b>
14	<b>Overflow</b>

## Contents

	Page
<b>Device setup</b> .....	<b>2</b>
<b>EU Declaration of Conformity</b> .....	<b>4</b>
<b>Note for USA (FCC)</b> .....	<b>4</b>
<b>Note for Canada (IC)</b> .....	<b>4</b>
<b>Explication of warning symbols</b> .....	<b>4</b>
<b>Safety instructions</b> .....	<b>5</b>
General information .....	5
Fluids .....	6
Refrigerant.....	6
Battery (Battery pack RB 1 for <b>WiCo</b> ) .....	6
Disposal instructions .....	5
<b>Intended use</b> .....	<b>7</b>
Use .....	7
Range of use.....	7
Wireless remote control .....	7
<b>Unpacking</b> .....	<b>8</b>
Unpacking .....	8
Delivery scope.....	8
<b>Preparations</b> .....	<b>8</b>
Setting up .....	8
Connecting the tubings.....	8
Inserting battery into the <b>WiCo</b> .....	9
Mounting the <b>WiCo</b> to the station.....	9
Filling and draining.....	9
Fluids (Standard information for <b>IKA</b> fluid) .....	11
Moving the device .....	12
Charging the Battery Pack RB 1 (rechargeable battery).....	12
Changing battery to <b>WiCo</b> .....	12
<b>WiCo</b> - holder WH 10.....	12
<b>Operator panel and display</b> .....	<b>13</b>
<b>station</b> .....	13
<b>WiCo</b> .....	13
<b>Commissioning and operating</b> .....	<b>14</b>
<b>Useful information</b> .....	<b>15</b>
<b>Working with WiCo</b> .....	<b>15</b>
Working screen at the time of delivery .....	15
Explanation of symbols on the working screen .....	15
Menu navigation and structure .....	16
Menu (Details) .....	18
<b>Interface and output</b> .....	<b>23</b>
<b>Maintenance and cleaning</b> .....	<b>26</b>
<b>Error codes</b> .....	<b>27</b>
<b>Accessories</b> .....	<b>28</b>
<b>Technical data</b> .....	<b>29</b>
<b>Warranty</b> .....	<b>31</b>
<b>Pump performance curve</b> .....	<b>31</b>

## EU Declaration of Conformity

We declare under our sole responsibility that this product corresponds to the regulations 2014/35/EU, 2006/42/EC, 2004/108/EC and 2011/65/EU and conforms with the standards or other normative documents: EN 61010-1, EN 61010-2-010, EN 61326-1, EN 60529, EN ISO 12100 and DIN 12876-1.

Bluetooth® module:

Directive: 2014/53/EU

Standards: EN 300328, EN 301489-17, EN 301489-1, EN 60950-1

A copy of the complete EU Declaration of Conformity can be requested at [sales@ika.com](mailto:sales@ika.com).

## Note for USA (FCC)

This equipment complies with Part 15 of the FCC rules. Any changes or modifications not expressly approved by the Manufacturer could void the user's authority to operate the equipment. This device complies with Part 15 of the FCC rules subject to the following two conditions:

- (1) This device may not cause harmful interference, and
- (2) This device must accept all interference received, including interference that may cause undesired operation.

### NOTE:

This equipment has been tested and found to comply with the limits for a Class B digital device, pursuant to part 15 of the FCC Rules. These limits are designed to provide reasonable protection against harmful interference when the equipment is operated in a commercial environment.

This equipment generates, uses, and can radiate radio frequency energy and, if not installed and used in accordance with the instruction manual, may cause harmful interference to radio communications. Operation of this equipment in a residential area is likely to cause harmful interference in which case the user will be required to correct the interference at his own expense.

## Note for Canada (IC)

This device complies with Industry Canada license-exempt RSS standard(s). Operation is subject to the following two conditions:

- (1) This device may not cause interference
- (2) This device must accept any interference, including interference that may cause undesired operation of the device.

This device complies with Health Canada's Safety Code 6/IC RSS-210. The installer of this device should ensure that RF radiation is not emitted in excess of the Health Canada's requirement.

## Explication of warning symbols



Indicates an (extremely) hazardous situation, which, if not avoided, will result in death, serious injury.



Indicates a hazardous situation, which, if not avoided, can result in death, serious injury.



Indicates a potentially hazardous situation, which, if not avoided, can result in injury.



Indicates practices which, if not avoided, can result in equipment damage.



Indicates the risk of fire or explosion!



Indicates crushing risk to fingers/hand.



Warning: flammable material!

## Safety instructions

### General information:

- **Read the operating instructions completely before starting up and follow the safety instructions.**
- Keep the operating instructions in a place where it can be accessed by everyone.
- Ensure that only trained staff work with the device.
- Follow the safety instructions, guidelines, occupational health, safety and accident prevention regulations.
- Set up the device in a spacious area on an even, stable, clean, non-slip, dry and fireproof surface.
- The device has been constructed to the requirements of EU (European Union) and EFTA (European Free Trade Association) countries.
- Do not operate the device in explosive atmospheres.
- Protect the device and accessories from bumping and impacting.
- Check the device and accessories for damage before each use. Do not use damaged components.
- Safe operation is only guaranteed with the accessories described in the "Accessories" section.
- The device must only be operated with the original power cable.
- The socket for the power cable must be easily accessible.
- Socket must be earthed (protective ground contact).
- The voltage stated on the type plate must correspond to the power voltage.
- The device can only be disconnected from the power supply by pulling out the power plug or the connector plug.
- Disconnect the power plug before attaching or changing any accessories.
- Disconnect the power plug before cleaning, maintenance and transportation of the unit.
- The device must only be opened by trained specialists, even during repair. The device must be unplugged from the power supply before opening. Live parts inside the device may still be live for some time after unplugging from the power supply.

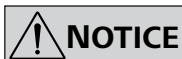

### NOTICE

Coverings or parts that can be removed from the device must be put back on the device again to ensure safe operation, for example to keep foreign objects and liquids, etc. from getting into the device.

- The device may only be used as prescribed and as described in these operating instructions. This includes operation by instructed specialist personnel.
- When using critical or hazardous materials in your processes, **IKA** recommends to use additional appropriate measures to ensure safety in the experiment. For example, users can implement comprehensive monitoring equipment.
- Process pathogenic material only in closed vessels under a suitable fume hood. Please contact **IKA** application support if you have any question.



### CAUTION

If the power switch is not within reach when device is operating, an **EMERGENCY STOP** switch that can be easily accessed must be installed in the work area.

- A laboratory circulator refrigerates and circulates fluid according to specified parameters. This involves hazards due to low temperatures and general hazards due to the device of electrical energy. The user safety can not be ensured simply with design requirements on the part of the device. Further hazard sources may arise due to the type of tempering fluid, e.g. by exceeding or undercutting certain temperature thresholds or by the breakage of the container and reaction with the carrier fluid. It is not possible to consider all eventualities. They remain largely subject to the judgment and responsibility of the operator. For this reason, it may become necessary for user to take other precautionary safety measures.
- Insufficient ventilation may result in the formation of explosive mixtures. Only use the device in well ventilated areas.
- When device is used for external circulation, extra precaution must be taken for cold fluid leakage due to damaged hose.
  - Use suitable hoses for connection.
  - Secure hoses and tubes against slippage and avoid kinks.
  - Check hoses, tubes and bath at regular intervals for possible material fatigue (cracks/leaks).



### WARNING

Do not start up the device if:

- It is damaged or leaking
- Cable (not only supply cable) is damaged.

- After a power failure during operation, the device may start automatically (depending on operating mode).



### WARNING

Because of the heavy weight of the device, at least two person are needed for carrying the device.

- Transport the device with care (see section "Moving the device").
- Do not transport or empty the bath while it is still cold. Check the temperature of the bath fluid before draining.
- Always empty the bath before moving the unit.

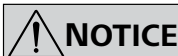

### NOTICE

Always empty the bath if the unit is unused for long time.

### Disposal of the device:

- The device must be disposed of in accordance with national or local regulations

### Fluids:



#### CAUTION

Only use the fluids, which fulfill the requirements for safety, health and device compatibility. Be aware of the chemical hazards that may be associated with the bath fluid used. Observe all safety warning for the fluids.

- Depending on the bath fluid used and the type of operation or toxic can arise. Ensure suitable extraction.
- Do not use any fluid which may cause dangerous reactions during processing.
- Only use recommended bath fluid. Only use non-acid and non corroding fluid.



#### NOTICE

Never operate the device without sufficient refrigeration carrier fluid! Check the fluid level detection at a regular basis (see the section "Filling and draining").

- Continuous monitoring of the bath and the filling level of the bath fluid is required.
- To ensure a sufficient fluid circulation, the viscosity of the bath fluid must not exceed of 50 mm<sup>2</sup>/s at the lowest operating temperature.
- Untreated tap water is not recommended. It is recommended to use distilled water or high purity water (ion exchangers) and add 0,1 g soda (sodium carbonate Na<sub>2</sub>CO<sub>3</sub>) /liter, to reduce corrosive properties.



#### NOTICE

Don't use following fluids:

- Untreated tap water
- Acids or bases
- Solutions with halides: chlorides, fluorides, bromides, iodides or sulfur
- Bleach (Sodium Hypochlorite)
- Solution with chromates or chromium salts
- Glycerine
- Ferrous water.

### Refrigerant:



#### WARNING

The device is not allowed to be used in an ATEX (Atmosphere EX-losible) zone.



#### WARNING

Flammable refrigerant used. Do not use mechanical devices or other means to accelerate the defrosting process, other than those recommended by the manufacturer.



#### WARNING

Do not damage the refrigerant circuit.

- Set the device in well-ventilated room and keep all ventilation openings in the enclosure or, in the structure for building, clear of obstruction.

- Flammable refrigerant used. Only the manufacturer can open the device and repair it. The third parties are not allowed to open the device!
- The device with a sealed refrigerating system with less than 150 g refrigerant. It can be located in any laboratory.

### Battery pack RB 1 (for WiCo):



#### NOTICE

If during operation the battery pack RB 1 (rechargeable battery) becomes fully discharged, the device (station) will continue to run or is shut down depending on the value settings for "Time Out", "Safe Speed" and "Safe Temperature". If the device is set so that it continues to run when the battery of the WiCo is fully discharged, the only means of switching the station off are the "safe STOP", "ON/OFF" key and the "Power switch"!



#### NOTICE

**Please note the following safety instructions for the battery pack RB 1 (rechargeable battery):**

- Keep the battery pack out of reach of children at all times.
- Store the battery pack in a cool, dry place.
- Never throw the battery pack into a fire. Keep it away from direct sunlight and temperatures above 60 °C. High temperatures will damage the battery pack and render it unusable. Temperatures above 100 °C may cause it to explode.
- Never throw the battery pack into water or expose it to moisture. Water may lead to a short-circuit, causing the battery pack to explode.
- Do not deform or crush the battery pack or damage it in any other way. This can cause battery fluid to leak and/or the battery pack to explode.
- When not in use, keep battery packs away from paperclips, coins, keys, nails, screws or other small metal objects which could cause the contacts to be bridged. Short-circuiting may result in an explosion.
- Explosion of a battery pack may release battery fluid and cause a fire.
- The lithium polymer battery pack must only be used and charged in **IKA** products designed for use with this battery pack.
- When the battery pack is inserted it should slide in easily and without resistance. Do not force it.
- If the battery pack is removed for an extended period of time, store it in a sealed plastic bag to prevent short-circuiting due to moisture or contact with metal components.
- The operating temperature range of the battery pack is from 0 °C to + 45 °C. Note that the battery pack capacity will be reduced at temperatures below 20 °C.
- Only the rechargeable battery types recommended in the technical data may be used in the device!



Do not charge batteries that have leaked or that are discolored, deformed or damaged in any other way.

### **Disposal instructions:**

- The device, packaging, accessories and batteries must be disposed of in accordance with national regulations.
- When disposing of the battery pack, please tape over the contacts with adhesive tape to prevent short-circuiting due to moisture or contact with metal components. Short-circuiting may result in an explosion.
- Do not throw used battery packs into your household waste. Dispose of them properly in accordance with statutory regulations.



End users are obliged by law to return all used disposable and rechargeable batteries. Throwing them into the household waste is prohibited. Disposable/rechargeable batteries containing harmful substances are marked with this symbol to indicate that they may not be disposed of as household waste.

## **Intended use**

### **Use:**

Use **RC** (Refrigerated Circulators) for cooling and circulating fluids.

### **Range of use:**

Indoor environments similar to that a laboratory of research, teaching, trade or industry.

### **Wireless remote control:**

Before using the wireless link between the **WiCo** and the laboratory device, first check whether your region is included in the radio communication approval for the device. If it is not, remote control can also be performed using a USB cable.

The safety of the user cannot be guaranteed:

- If the device is operated with accessories that are not supplied or recommended by the **IKA**.
- If the device is operated improperly or in contrary to the **IKA** specifications.
- If the device or the printed circuit board are modified by third parties.

## Unpacking

### Unpacking:

- Please unpack the device carefully.
- Any damage should be notified immediately to the shipping agent (post office, railway network or logistics company).

### Delivery scope:

- **RC 5 control** with **WiCo**
- Power cables
- Hose olive NW 8 (2 pieces) see Fig. 2
- Hose olive NW 12 (2 pieces) see Fig. 2
- **WiCo** holder WH 10
- OS 1.0 power supply (for **WiCo**) see Fig. 3
- Temperature sensor Pt 100.30
- USB 2.0 cable (micro A – micro B)
- USB 2.0 cable (A – micro B)
- Plastic cap (for "**Overflow**" connector)
- Plastic cap (for "**Backflow**" connector)
- User guide
- Warranty card.

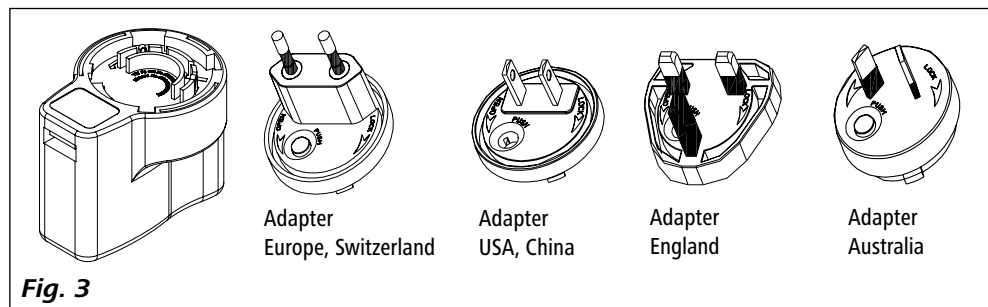
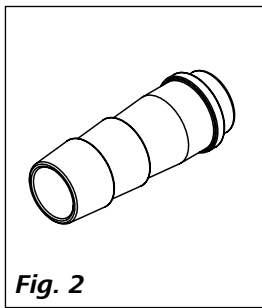

## Preparations

### Setting up:

- Place the unit on an even, stable, clean, nonslip, dry and fireproof surface.
- Keep at least 20 cm of open space on the front and rear side.
- The place for installation should be large enough and provide sufficient air ventilation to ensure the room does not warm up excessively because of the heat from device radiates to the environment.
- Do not set up the device in the immediate vicinity of heat sources and do not expose to sun light.
- Cooling machine, pump motor and electronics produce intrinsic heat that is dissipated via the venting grids (4)! Never cover these venting grids!

**Note:** After setting up the device, wait at least one hour before starting the operation to avoid the damage to the cooling system.

### Connecting the tubings:

- Unscrew the union nuts and stoppers using a wrench (AF 19) from the pump connector **IN** and **OUT**.

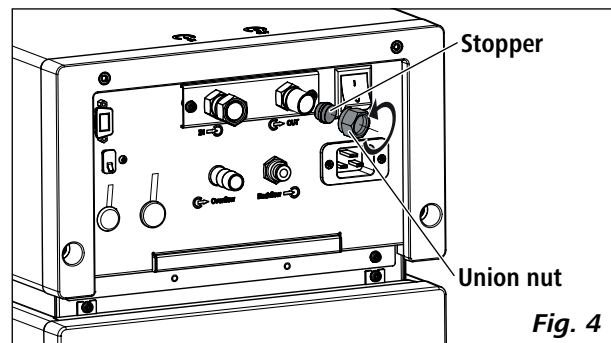

- Connect the hoses for circulating the external system to the pump connection M 16 x 1 for **IN** and **OUT** directly or with the olives.



- Screw the hose olives to the pump connector **IN** and **OUT** with union nuts. Slide the hoses (NW 12) onto the olives. The hoses must be secured with suitable clamps.

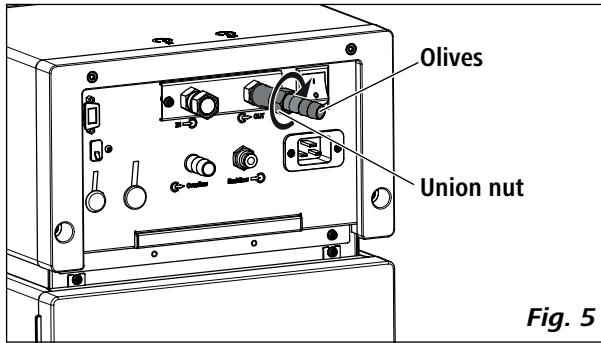

Fig. 5

- Via a hose to the **“Overflow”** connection, overflowing fluid can be directed into a suitable vessel. The vessel should be positioned lower than the **“Overflow”** connection

In case of closed external system, if there is in any case no risk of exceeding the maximum fluid level, you can close the **“Overflow”** connection with the included overflow cap. This minimizes the energy loss and protects, in case of long-term applications with low temperatures and high humidity, against unwanted water input and the associated volume increase.

Check fluid heat expansion!

- Connect the **“Backflow”** connection to **IKA** calorimeter with a suitable hose.

When **IKA** calorimeter is not connected, please close the **“Backflow”** connection with included backflow cap.

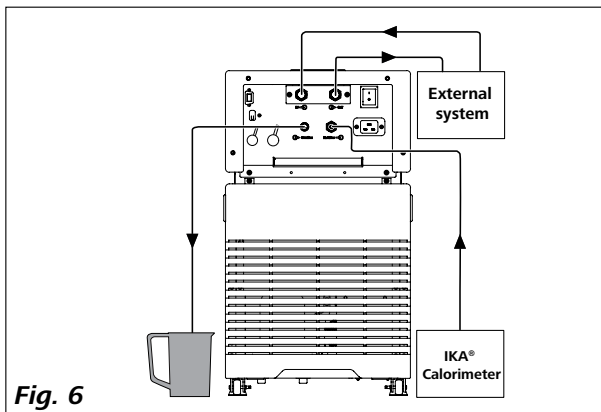

Fig. 6

**Note:** When the external system is not necessary, please seal the pump connector **IN** and **OUT** with the existing union nuts and stoppers.

### Inserting battery into the WiCo:

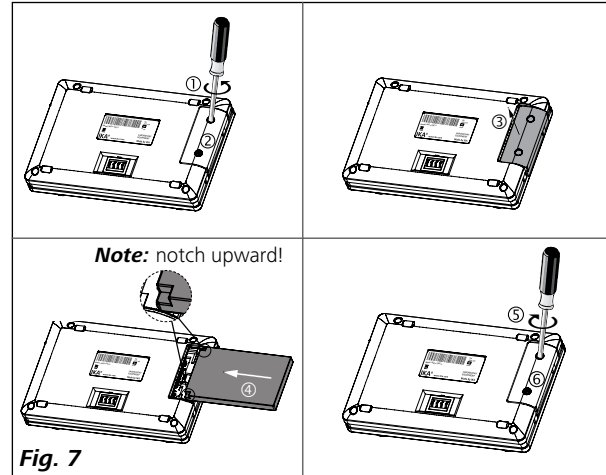

Fig. 7

### Mounting the WiCo to the station:

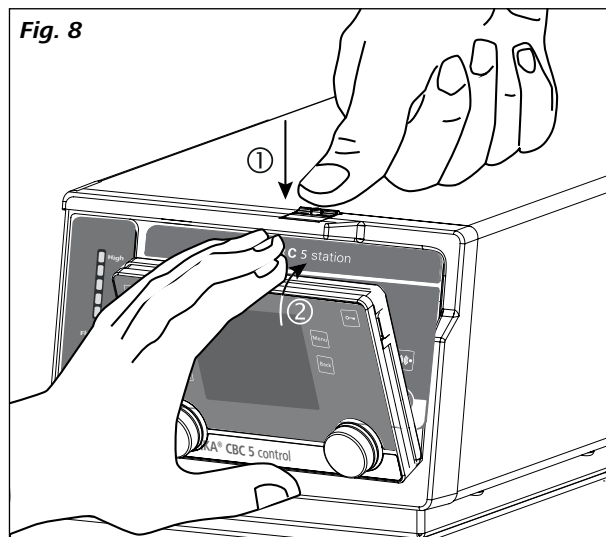

Fig. 8

**Note:** If the **WiCo** need be permanently attached to the station, we strictly recommend to fasten the unlocking button with the integrated screw (turn counter clock wise).

### Filling and draining:

- Before filling the fluid into the bath, open the venting grid as indicated in following figure.

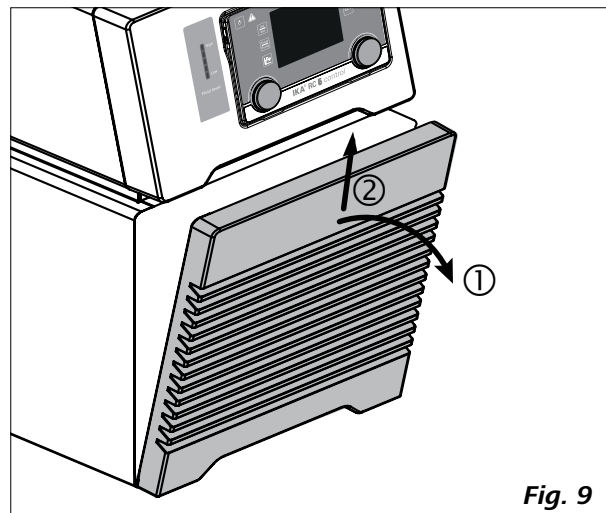

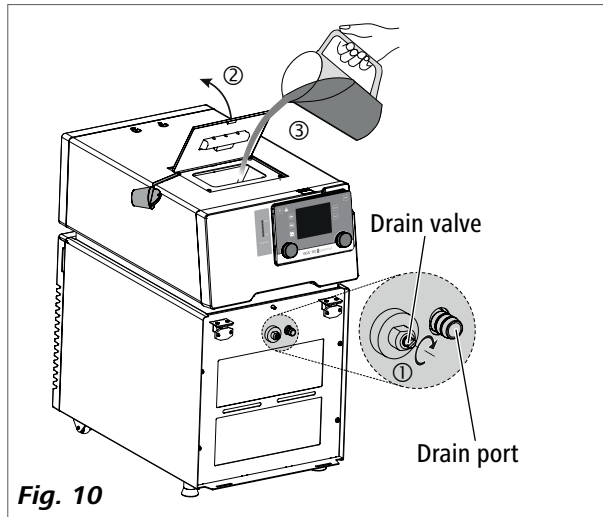

Fig. 9

- Check and make sure that the drain valve is closed (rotate clockwise to the stop position, see Fig. 10).



**Note:** Please note information in section “Commissioning and operating”.

- Connect the power plug and turn on the device with power switch.
- The low level icon (  ) appears on the display of the **WiCo**. Meanwhile, the bottom LED segment of fluid level indicator lights up in red color to indicate the low fluid level.
- Open the filling opening lid and remove the stopper from the filling opening. Then, fill fluid to the bath.



**Note:** Pay attention to the fluid level information.

Fluid level information on the **WiCo** display:

-  — Low level
-  — High level

Fluid level information on the fluid level indicator:

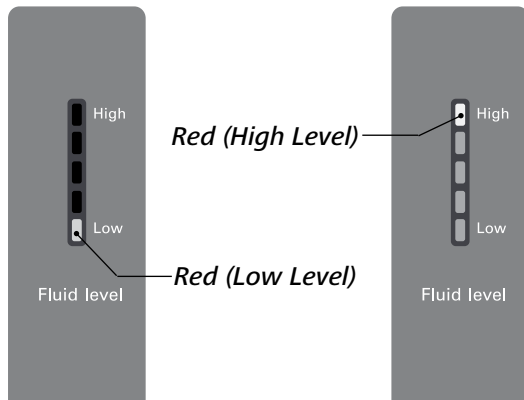

- To drain the fluid from the bath, connect a hose to the drain port and turn the drain valve in counter clockwise direction with a straight screwdriver.

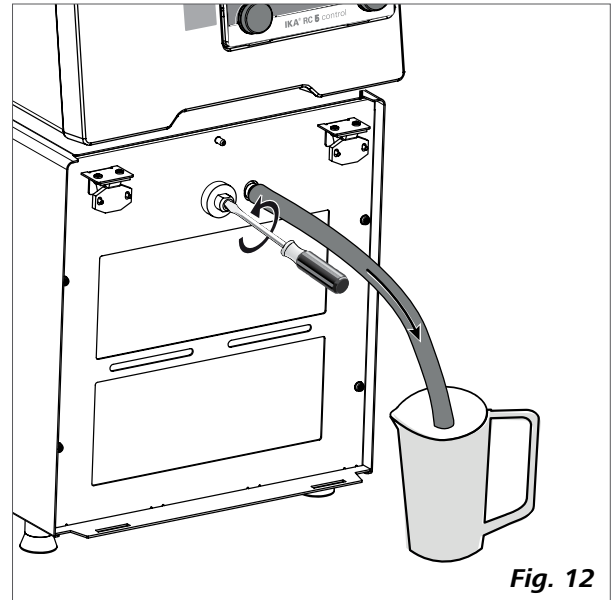

**Warning:** Do not empty the bath while it is still cold, there is a risk of freezing.

**Fluid (Standard information for IKA fluid):**

IKA Designation	Operating temperature range for open bath application (°C)	Operating temperature range for closed bath applications (°C)	Safety temperature (°C)	Flash point (°C)
CF.EG28.N10.80.8	-10 ... 80	-10 ... 80	90	115
CF.EG39.N20.80.16	-20 ... 80	-20 ... 80	90	115
CF.EG44.N25.80.19	-25 ... 80	-25 ... 80	90	115
CF.EG48.N30.80.22	-30 ... 80	-30 ... 80	90	115
UF.Si.N30.150.10LV	-30 ... 130	-30 ... 150	145 ❶	>170
HF.Si.20.200.50	20 ... 200	20 ... 200	255	>280
HF.Si.20.250.50A	20 ... 200	20 ... 250	255	>280
H <sub>2</sub> O (Water) ❷	5 ... 95	5 ... 95	-	-
Customized 1 ❸				
Customized 2 ❸				

Check the suitability of the fluid according to your application.

Nomenclature for IKA fluid:

CF.EG28.N10.80.8 --

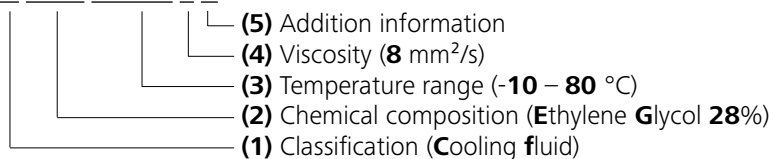
**(1) Classification:**

**HF:** Heating Fluid

**CF:** Cooling Fluid

**UF:** Universal Fluid

**(2) Chemical composition:**

**Si:** Silicone oil

**EG:** Ethylene Glycol

**(3) Temperature range:** (Minimum temperature. Maximum temperature)

**N:** Negative Temperature

**(4) Viscosity:**

Viscosity at 25 °C for Heating Fluid (HF)

Viscosity at -20 °C for Cooling Fluid (CF)

Viscosity at 25 °C for Universal Fluid (UF)

Dynamic viscosity [mPa.s] is a product of kinematic viscosity [mm<sup>2</sup>/s] and density [kg/m<sup>3</sup>] of the fluid divided by 1000.

**(5) Additional information:**

**A:** Oil Additives

**LV:** Low Viscosity

**❶ Note:** for open bath application!

**❷ Note:** Tap water may be unsuitable for operation because the calcium carbonate content may cause calcification.

High purity water (from ion exchangers) and distilled or bi-distilled water are unsuitable for operation due to corrosive properties of these media. High purity water and distillates are suitable as a medium after adding 0.1 g soda (Na<sub>2</sub>CO<sub>3</sub>, sodium carbonate) per liter of water.

**❸ Note:** The temperature limit values are adjustable in accordance with the fluid used.

### **Moving the device:**

Empty all fluid in the bath before move device from one place to other place.

The device must be lifted by two persons with the upper handles.

It can also be moved on flat surface by lifting and pushing the front of the device. It is easy to move the device with the help of the rolling of the wheels.

The angle of inclination should never more than 10 ° at any direction when move the device!

**Note:** The device must not be moved during operation. After moving the device, you must wait for at least one hour before restarting the unit.

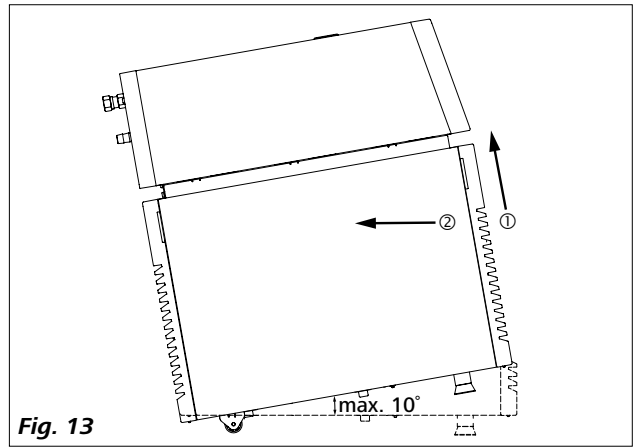

**Fig. 13**

### **Charging the Battery Pack RB 1 (rechargeable battery):**

The battery pack in the **WiCo** can be charged by any of the following means:

- On the **station**
- Via a USB cable at the PC or **station**
- Via an OS 1.0 power supply unit.

### **Replacing battery to WiCo:**

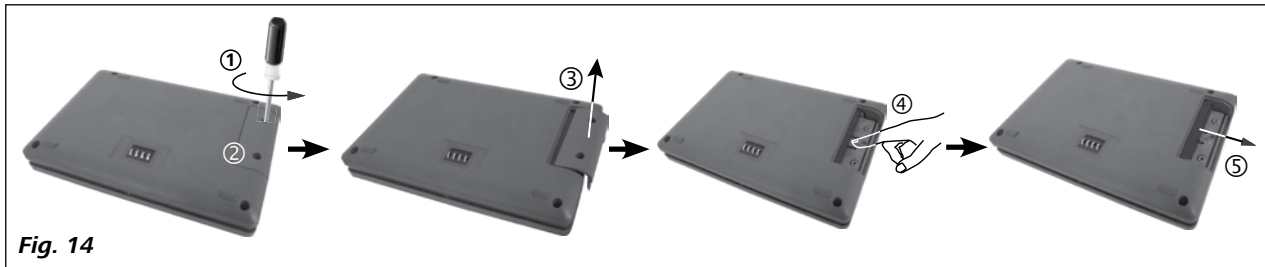

**Fig. 14**

**Notice:** Please comply with the relevant safety instructions in the "Safety instructions" section for the RB 1 battery pack!

### **WiCo – holder WH 10:**

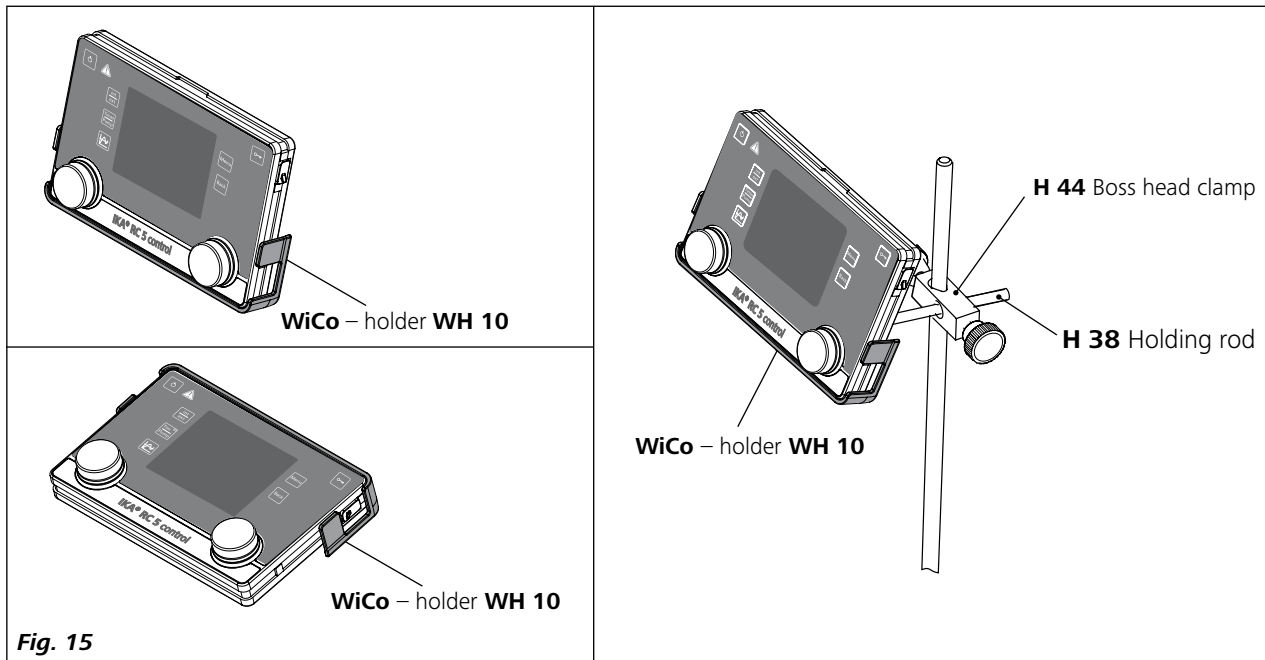

**Fig. 15**

## Operator panel and display

**station:**

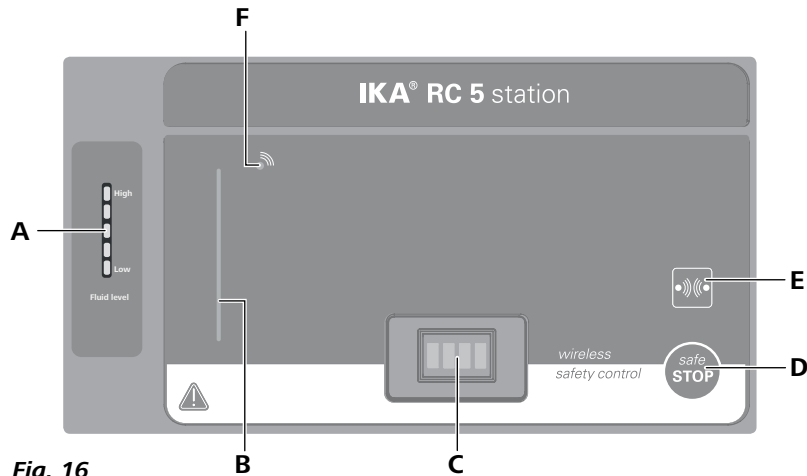

Fig. 16

Item	Designation	Function
A	<b>Fluid level indicator:</b>	Indicate the bath fluid level (when the fluid level is too low or too high, the bottom or the top LED segment change into red color).
B	<b>LED bar:</b>	Display different status of the circulator with different color.
C	<b>Contacts:</b>	Communicate and charge the <b>WiCo</b> .
D	<b>safe STOP key:</b>	Safely stop the working of the circulator in emergency.
E	<b>Bluetooth® searching key:</b>	Search the <b>WiCo</b> when the Bluetooth® is active.
F	<b>Bluetooth® LED:</b>	Bluetooth® indicator.

**WiCo:**



Fig. 17

Item	Designation	Function
L	<b>On/Off button:</b>	Switch the <b>WiCo</b> on and off.
M	<b>"int/ext" button:</b>	Switch between the internal and external temperature display and control.
N	<b>"Timer/Pump" button:</b>	Switch between the timer and pump display.
O	<b>Graph button:</b>	Display time/temperature graph.
P	<b>Rotating/pressing knob:</b>	Set the temperature value.
R	<b>Rotating/pressing knob:</b>	Start/Stop the cooling function.
R	<b>Rotating/pressing knob:</b>	Navigation, selecting and changing the settings in the menu.
R	<b>Rotating/pressing knob:</b>	Set the pump speed value.
R	<b>Rotating/pressing knob:</b>	Start/Stop the pump function.
S	<b>Display:</b>	Screen.
T	<b>"Back" button:</b>	Return to the previous menu level.
U	<b>"Menu" button:</b>	Press it once: main menu is displayed.
U	<b>"Menu" button:</b>	Press it a second time: back to the working screen.
V	<b>Lock button:</b>	Lock/Unlock the knobs and buttons.

## Commissioning and operating

**Note:** Before commissioning, make sure that the device has not been moved for one hour!

Check whether the voltage given on the type plate corresponds to the available power voltage.

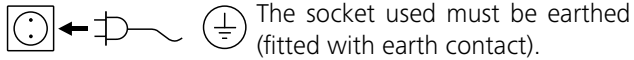

If these conditions have been met, the machine is ready for operation when the power plug is plugged in.

If these conditions are not met, safe operation is not guaranteed and the machine could be damaged.

Observe the ambient conditions (temperature, humidity, etc.) listed under "Technical Data".

After switching on the power switch of the **station**, the screen of the **WiCo** displays the device designation and the software version after a beep.



**Fig. 18**

After several seconds, screen display the information of **WiCo**.

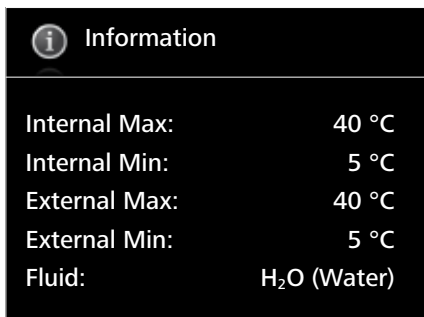

**Fig. 19**

Then the working screen appears and the device is ready for operation.

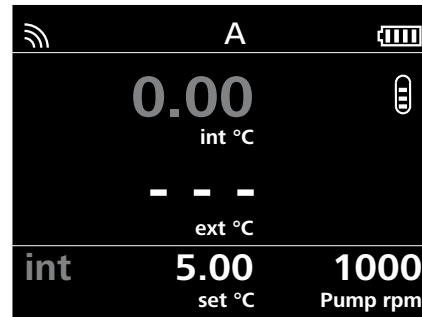

**Fig. 20**

Change the temperature setting with left knob (P).

Change the pump speed setting with the right knob (R).

In standby status, activate the refrigerating function by pressing the left knob (P). The pump and fan starts to run at once. The refrigerating function may delay to start at maximum 2 minutes.

In working status, press the right knob (R) to stop operation of the pump. The refrigerating function and the pump stops.

**Note:** In standby status, press the right knob (R) to start the pump function, the refrigerating function will not be activated.

In working status, press the left knob (P) to stop the refrigerating function, the pump keep running.

When the **WiCo** is switched on without being connected to the **station**, the green LED bar (B) and the green Bluetooth® LED (F) on **station** lights up.

The control elements of the **WiCo** allow locked by pressing the lock button (V) about 2 seconds, so no accidental changes during operation are possible (lock symbol  appears in the display).

By pressing lock button (V) about 2 seconds again, the control elements are released (lock symbol  disappears from the display).

**Note:** In an emergency, the device function can be turned off by pressing the "safe STOP" button (D) at the front of **station**. The LED bar (B) changed into red color.

A message appears in the display indicates that the **station** was forced off. To restart, press the power switch off and on again.

If the Bluetooth® function of the **WiCo** is activated, the Bluetooth® icon  appears on the screen and the user can search the **WiCo** by pressing the searching button (E). Then, a beep is heard.

## Useful information

The **station** is controlled via a **WiCo**. If the **WiCo** is mounted on the **station**, data is exchanged between the **station** and **WiCo** via the contacts (C). The screen of the **WiCo** displays the home icon .

The **WiCo** is equipped with a USB socket (Universal Serial Bus) with which the **WiCo** can be connected with **station**, the USB icon  appears on the screen.

If the **WiCo** is not connected with **station** via a USB cable, the data exchange between the **station** and the **WiCo** via Bluetooth®. In this case, the Bluetooth® icon  is displayed.

Depending on the structure of the building, the **WiCo** can be operated at a distance up to 15 m from the **station**, using the Bluetooth® connection.

The **WiCo** could be either installed on the **station** or put on a safe place where is accessed easily by the user during operation.

If the **WiCo** is mounted on the **station**, the battery is charged through the contacts (C).

The battery could also be charged via the USB port on the **WiCo** (See "Charging the Battery Pack RB 1" in "Preparations" section).

## Working with WiCo

### Working screen at the time of delivery:

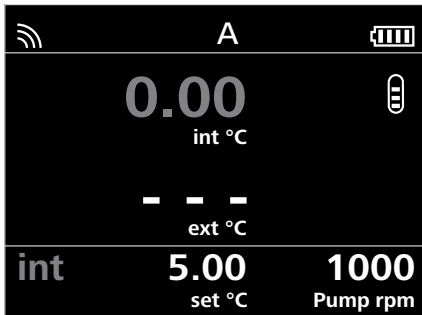

Fig. 21

**Note:** The wireless symbol  appears only when the **station** is switched on.

### Explanation of symbols on the working screen:

The symbols displayed change depending on the status and settings of the **WiCo** and the **station**. The screen below shows the most significant symbols on the working screen.

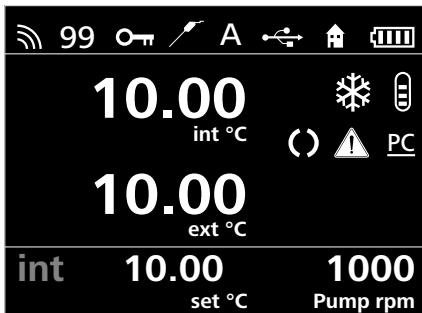

Fig. 22

### Bluetooth®:

This symbol means the **station** and the **WiCo** are communicating via Bluetooth®.

The symbol no longer appears if no Bluetooth® communication is being performed.

### 99 Device number:

This figure appears when the "Device Number" is activated in menu option "Display".

The figure can be set from 0 to 99.

See section "Display" under "Menu (Details)".

### Lock:

This symbol means that the function of the keys and the rotary knobs for controlling the **WiCo** are disabled.

The symbol no longer appears if the functions are enabled once again by pressing the key button a second time.

### Temperature Sensor:

This symbol appears when the external temperature sensor is connected.

### A Operating Mode:

This symbol indicates the operating mode currently selected (A, B, C, D).

### USB:

This symbol means the **WiCo** is communicating or the battery is charged via a USB cable. The symbol no longer appears if no USB cable is being used for communicating with the **station**.

### Home:

This symbol means that the **WiCo** is connected to the **station** and is communicating with the **station** via the contacts.

The symbol no longer appears if the **WiCo** is removed from the **station**.

### **Battery pack:**

This symbol indicates the charging status of the RB 1 battery pack within the **WiCo**.

The charging symbol appears if the **WiCo**

- Is connected to a PC via a USB cable
- Is connected to a **station** via a USB cable
- Is connected to the power supply unit OS 1.0 via a USB cable
- Is connected to the **station** via the charger contacts.

### **Refrigerating**

This symbol indicates that the refrigerating function is active.

\* →  indicates active refrigerating process.



### **Fluid level:**

This symbol indicates fluid level.

The red symbol  means the fluid is above the maximum fluid level. Excess fluid should be drained out.

The red symbol  means the fluid is below the minimum fluid level. Please add fluid.

### **Pump:**

This symbol indicates that the pump is activated.

### **Warning:**

This symbol indicates that warning is active.

### PC **PC Control:**

This symbol means that either the **station** or the **WiCo** is connected to a computer and is being controlled from the computer.

### PR **Program Control:**

This symbol indicates that the **WiCo** is controlled by a program (see "PROGRAMS").

## **Menu navigation and structure:**

Menu navigation:

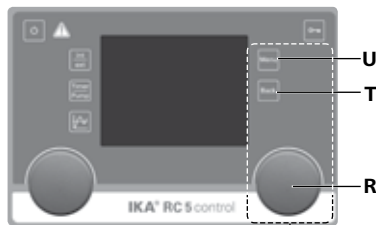
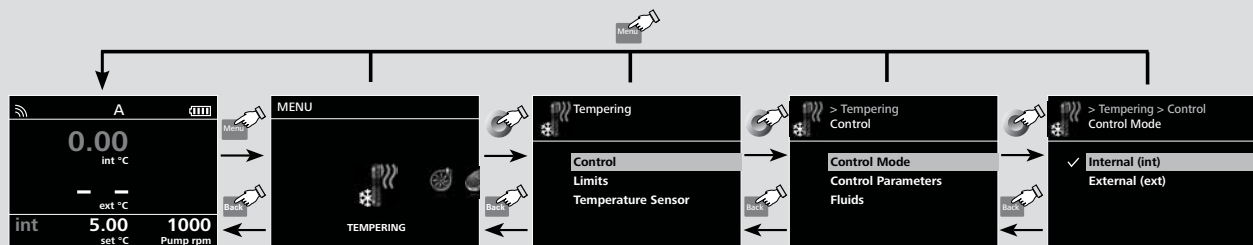

**Fig. 23** Control elements for menu navigation

- ☞ Press the "Menu" button (U).
- ☞ Select the menu by turning the right rotating/pressing knob (R) to the right or left.
- ☞ Open the menu item by pressing the right rotating/pressing knob (R).
- ☞ Turn the rotating/pressing knob (R) to select the desired menu option and edit the values or settings.
- ☞ Press the rotating/pressing knob (R) to get into sub menu items to active/inactive to switch settings or to confirm settings ("OK").
- ☞ Press the "Back" button (T) to a setting or cancel to return to the previous menu.
- ☞ Press the "Menu" button (U) to return directly to the working screen.

**Note:** When the tempering or pump functions are active, the menu is locked. On the display, the active menu option is highlighted in yellow. The active status of a menu item is marked with a check (✓).

**Menu navigation:** → Press the "Menu" button (U) and rotate rotating/pressing knob (R).  
← Press the "Back" button (T) or the "Menu" button (U).



**Note:** If you press the "Menu" button (U), the system skips directly back to the working screen.  
If you press the "Back" button (T), the system skips back to the previous screen.

**Fig. 24**



Menu structure:

		Factory Settings			
TEMPERING	Control	Control Mode	Internal (int) .....	activated	
			External (ext) .....	-	
		Control Parameters	Automatic .....	activated	
			Manual .....	-	
		Fluids	CF.EG28.N10.80.8 .....	Internal (Kp, Ti, Td, Ts, Prop_Bp, Prop_Bn) .....	3.0, 20.0, 2.0, 3s, +2.00, -1.00
				External (Kp, Ti, Td, Ts, Prop_Bp, Prop_Bn) .....	3.0, 20.0, 2.0, 3s, +2.00, -1.00
				Information (Kp, Ti, Td, Ts, Prop_Bp, Prop_Bn) .....	-
				CF.EG39.N20.80.16 .....	-
				CF.EG44.N25.80.19 .....	-
				CF.EG48.N30.80.22 .....	-
	UF.Si.N30.150.10LV .....			-	
	HF.Si.20.200.50 .....			-	
	HF.Si.20.250.50A .....			-	
	H <sub>2</sub> O (Water) .....			activated	
	Customized 1 .....	-			
	Customized 2 .....	-			
	Limits	External (ext)	Maximum .....	40 °C	
			Minimum .....	5 °C	
	Temperature Sensor	Calibration	Internal	2 Point Calibration .....	-
				3 Point Calibration .....	-
		External	2 Point Calibration .....	-	
			3 Point Calibration .....	-	
	Reset Calibration	Internal .....	-		
		External .....	-		
	Notification	ON .....	-		
Hysteresis .....		± 0.0 K			
Sound .....		Infinite Beep .....	-		
PUMP	Limits	Speed	Maximum .....	4600 rpm	
			Minimum .....	1000 rpm	
		Pressure	Maximum .....	0.7 bar	
TIMER	Set .....	-			
	Display .....	00:00 [hh:mm]			
MODE	A .....	activated			
	B .....	-			
	C .....	-			
	D .....	-			
DISPLAY	Main Screen	Pump .....	activated		
	Timer .....	-			
Device number	-	-			
	-	0			
GRAPH	Automatic	-	activated		
		-	activated		
	Manual	Axis Assignment	Set Temperature .....	activated	
			Actual Internal Temp. ....	activated	
		Axis Scaling	X - Axis	15 min .....	-
				30 min .....	activated
				60 min .....	-
				120 min .....	-
			Y - Axis	Maximum .....	40 °C
				Minimum .....	5 °C
PROGRAMS	Program 1 .....	-			
	Program 10 .....	-			
MODULES	M1 - Valve	ON .....	Default Status	Open .....	activated
			Closed .....	-	
		Refill .....	Start .....	Level 2	
			Stop .....	Level 4	
		M2 - Output	Alarm	Error .....	-
				Warning .....	-
	Default Status	Open .....	activated		
		Closed .....	-		
	Switch	ON .....	-		
		Default Status	Open .....	activated	
	Closed .....	-			
	M3 - Input	Ext. Standby	ON .....	-	
Default Status			Open .....	activated	
Closed .....	-				
OUTGAS	Speed .....	1000 rpm			
	Interval .....	10 s			
SAFETY	Time out	Set .....	00:30 [mm:ss]		
		Speed .....	1000 rpm		
	Temperature .....	30.00 °C			
Password .....	-	000			
SETTING	Languages	English .....	actiaaed		
		Deutsch .....	-		
		... .....	-		
	Display	Background	Black .....	activated	
			White .....	-	
		Brightness	Standard Mode .....	100%	
			Battery Mode .....	40%	
	Firmware Update Info .....	-			
	Key Tone .....	-			
	Sound .....	-			
	Factory Settings	-	-		
	Communication	Device name .....	Circulator WiCo		
Bluetooth .....		activated			
Information	Tempering .....	yes			
	Pump .....	yes			
	Safety .....	yes			
	Software .....	yes			
	Intro .....	yes			
Firemware Update Info .....	yes				

## Menu (Details):



### TEMPERING:

#### 1. Control:

##### 1) Control Mode:

**Internal (int):** The temperature is regulated according to the internal temperature sensor.

**Extern (ext):** The temperature is regulated according to the external temperature sensor.

##### 2) Control parameters:

**Automatic:** The optimal control parameters for PID temperature control are determined automatically. This is the recommended mode.

Selecting "Automatic" allows you to set the dynamics for temperature control.

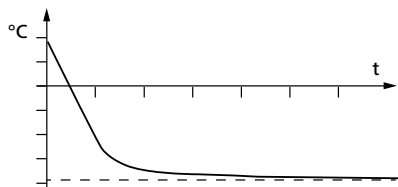

Fig. 25 (cooling curve in "Automatic" mode)

**Manual:** The control parameters for PID temperature control can be set manually.

"Manual" should only be used in the event of special temperature control requirements.

When "Manual" is selected, the following parameters can be set for "Internal (int)" and "External (ext)" temperature control:

**Kp:** Proportional coefficient

The proportional coefficient **Kp** is the controller amplification and determines how strongly the control deviation (the difference between the target temperature and actual temperature) directly affects the control variable (on-time of the cooling). **Kp**-values that are too large can lead to the controller overshooting.

**Ti:** Integral time

The integral time **Ti** (s) is the correction time and determines how strongly the duration of the control deviation affects the control variable. **Ti** compensates for an existing control deviation. A high **Ti** means a smaller and slower effect on the control variable. **Ti**-values that are too small can lead to instability of the controller.

**Td:** Differential time

The differential time **Td** (s) is the derivative time and determines how strongly the rate of change of the control deviation affects the control variable. **Td** compensates for rapid control deviations. A high **Td** means a smaller and slower effect on the control variable. **Td**-values that are too large can lead to instability of the controller.

**Ts:** Sampling time

The sampling time **Ts** (s) is the time interval over which the control deviation is determined and the respective control variable (dependent on **Kp**, **Ti** and **Td**) is calculated.

**Ts** must be adjusted to match the response characteristic (total of all time constants) of the closed loop controlled system, so that the control variable can deliver a uniform and measurable change in the control deviation. **Ts** values that are too small or too large can lead to instability of the controller.

**Prop\_Bp:** Proportional Band Maximum.

**Prop\_Bn:** Proportional Band Minimum.

The Proportional Band is the range below (**Prop\_Bp**) and above (**Prop\_Bn**) the set value in which the control output value is calculated via the difference between the actual and the set value and the PID parameters.

Examples of non-optimal settings:

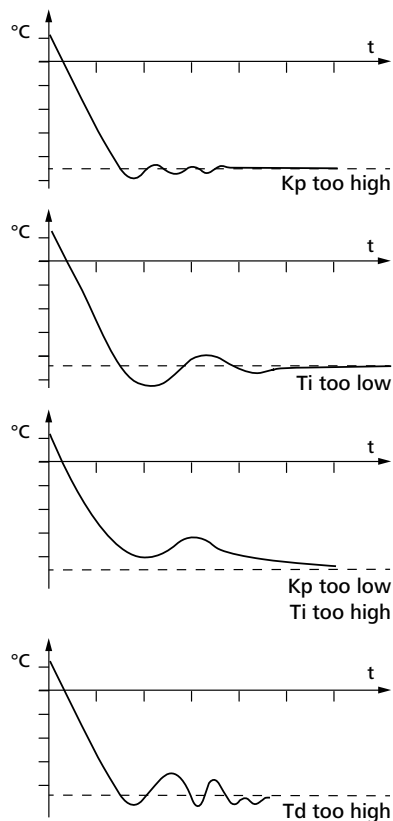

Fig. 26

#### 3) Fluids:

Under the option "Fluids", a variety of fluids can be selected. The selected fluid limits the setting range of the target temperature. See table in the section "Fluids (Standard information for IKA fluid)".

The maximum and minimum temperature values of the selected fluid can be set within these limitations.

#### 2. Limits:

Under the option "External (ext)", the maximum and minimum temperature for external temperature control can be set.

Under " $|\Delta T$  (int - ext) |", the maximum difference between the internal and external temperature can be set.

The function limits the absolute temperature difference between the external system and internal bath during the heating up and cooling down process. This can protect sensitive device like the glass reactors from thermal shock (e.g. glass break).

### 3. Temperature sensor:

#### 1) Calibration:

The internal and external temperature measurement can be calibrated and adjusted.

You can select 2-point calibration or 3-point calibration for internal and external measurement.

Calibration proceeding (example: 2-point calibration):

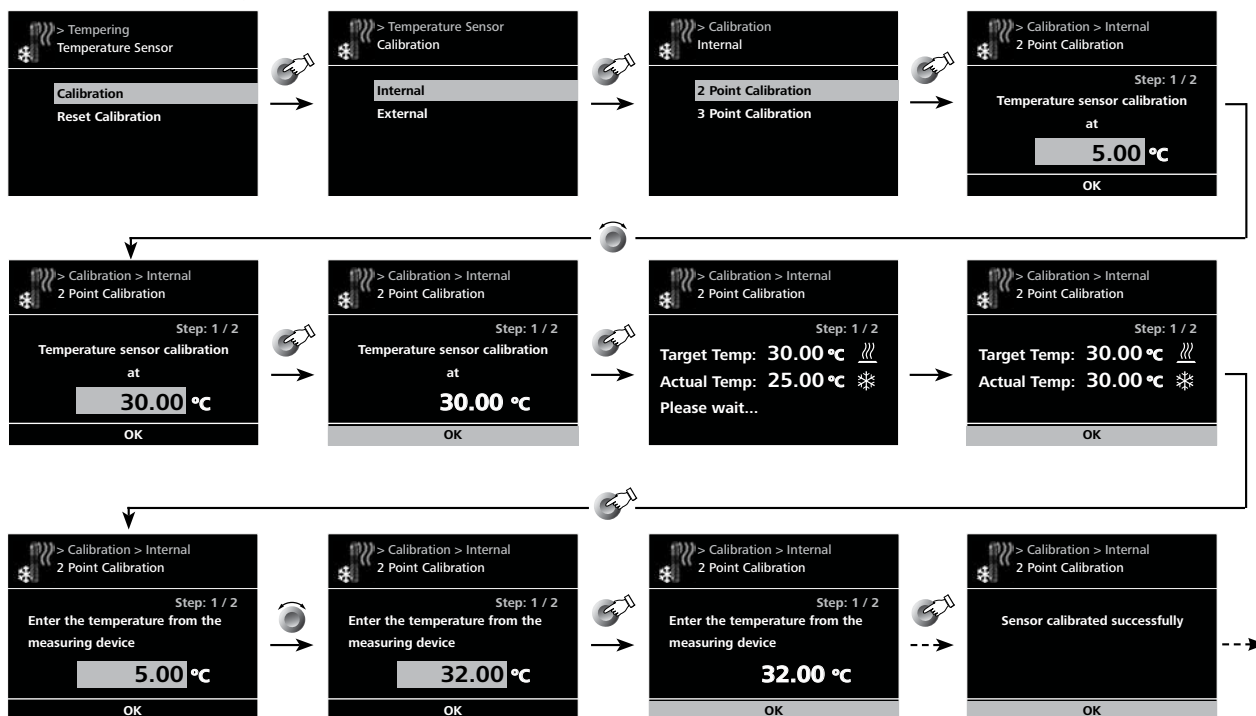

Fig. 27

#### 2) Reset Calibration:

By “Reset Calibration”, the calibration value for the internal or the external temperature sensor will be deleted.

### 4. Notification:

#### 1) ON:

This menu option allows you to activate/deactivate the “Notification” function. A green check mark and a beep informing when the target value (hysteresis) has been reached.

#### 2) Hysteresis:

This menu option allows you to set the hysteresis from 0 to  $\pm 2.0$  K.

#### 3) Sound:

**Infinite:** Beep until you press the “Back” button.

**Beep:** Single beep.



### PUMP

#### Limits:

In “Limits” option, the user is allowed to set the maximum and minimum speed to the pump, and also the maximum pressure.



### TIMER

#### 1. Set:

The user can set a target time (duration). When device functions are started normally, this time is displayed on the working screen. The device functions stop automatically once this time has expired. The running time is then displayed again on the display.

**Note:** To deactivate the target time specification, set the target time to 00:00.

#### 2. Display:

Activate the timer display on the main display (working screen).



## MODE

### **1. Operating Mode A:**

After power-on/power failure no automatic restart of functions.

### **2. Operating Mode B:**

After power-on/power failure automatic restart of functions, depending on previous settings.

### **3. Operating mode C:**

Set values (set in A or B) cannot be changed.

After power-on/power failure automatic restart of functions, depending on previous settings.

### **4. Operating mode D:**

Confirmation request for set value changes, if functions are active. After power-on/power failure no automatic restart of functions.



## DISPLAY

### **1. Main Screen:**

In the "Main Screen" menu option, you can specify what information will be displayed on the screen.

### **2. Device Number:**

In the "Device number" menu option, you are allowed to edit the device number from 0 to 99 that will be shown on the main screen.

When using multiple units, it may be helpful to identify WiCo and station.

**Note:** Labeling device number to the station.



## GRAPH

In this menu, you can set the options for the time-temperature diagram.

### **1. Automatic:**

The scaling of the temperature axis (Y-axis) is automatically determined, depending on the target temperature and the actual internal and external temperature.

The time axis (X-axis) is permanently scaled to 30 minutes.

### **2. Manual:**

#### **1) Axis Assignment:**

The temperature values to be displayed can be selected.

#### **2) Axis scaling:**

Scaling of the time (X) and temperature axis (Y) can be selected or set.



## PROGRAMS

Under programs, 10 user-defined temperature-time profiles can be created. A program can consist of up to 10 segments.

Once a program has been selected, the following options are available:

### **1. Start:**

Starts the program upon request of loop mode.

**1) Infinite loop:** Upon completion of the last segment, the program continues with the first segment until the user ends the program by stopping a device function.

**2) Loop Count:** Indicates the total number of loop cycles until program end.

**Note:** At the end of the program all device functions are switched off.

### **2. Edit:**

Edit/change the selected program.

**1) Seg No.:** Segment number.

**2) Ctrl. Sensor (int/ext):** Determines whether control is through the internal (int) or external (ext) temperature sensor.

**3) Temp.:** Target temperature.

**4) Ctrl.Mode (Time / +/- x.x K):** In "Ctrl.Mode Time" the target values and settings of the segment are valid for the duration indicated in the column "Time hh:mm". Afterwards, the next program segment is automatically executed.

In "Ctrl.Mode +/- x.xx K", the hysteresis (tolerance) of the actual temperature to the target temperature is set (e.g. +/- 0.1 K). The target values and settings of the segment are valid until the actual temperature reaches the target temperature +/- hysteresis for the first time. Afterwards, the next program segment is automatically executed.

**5) Pump rpm:** Target speed of pump.

**6) M1 (ON/OFF):** MODULES M1-Valve:

**OFF:** M1 valve in initial state

**ON:** M1 valve in inverted initial state.

**Note:** The initial state of the M1 valve is defined in "MODULES M1-Valve" in "Default Status" as "Open" or "Closed".

**7) M2 (ON/OFF):** MODULES M2-Output switch

**OFF:** M2-output switch in initial state.

**ON:** M2-output switch in inverted initial state.

**Note:** The initial state of the M2-Output switch is defined in "MODULES M2-Output" in "Default Status" as "Open" or "Closed".

**Edit:** Edit/change the selected program parameters.

**Delete:** Delete the selection highlighted in yellow program segment.

**Insert:** Inserts a new program segment after the selected segment.

**Save:** Saves changes.

### **3. Delete:**

Deletes the selection highlighted in yellow program.

**1) OK:** Confirm the process.

**2) Cancel:** Cancels the process.

### **4. View:**

Temperature-time overview displays for the program with segments of the selected program.

**Note:** If hysteresis is set as "Ctrl.Mode +/-x.xx K" for one or more segments in the program, the duration of the program cannot be determined.

Press and turn the knob (R) to display the segment details.

Once the program has been started, the program no., segment no. (active/total) and the remaining duration of the segment or hysteresis are displayed in the graph.



## **MODULES:**

In "Modules" the multifunction connection outputs and inputs can be configured.

The outputs M1 and M2 can be controlled via "PROGRAMS".

### **1. M1-Valve:**

#### **1) ON:**

Switch the external valve to the active state (inverted initial state).

**Note:** In a started „Program“ the M1 segment settings have higher priority.

#### **2) Default Status:**

Define the default state (OFF) of the external valve as "Open" or "Closed". It depends on the valve type (normally open or closed).

#### **3) Refill:**

Use the external M1 valve to automatically check the level when operating with water.

Observe "Default Status" setting.

**Start:** Set the valve switch-on point (ON).

**Stop:** Set the valve switch-off point (OFF).

**Note:** Prior to using the "Refill" menu option, check the function of the buoyage.

The "Refill" menu option has higher priority than the program M1 segment settings.

## **2. M2-Output:**

### **1) Alarm:**

Activate the alarm output (switch contact).

**Error:** In case of an error the "M2-Output — Switch" is activated (ON, inverted initial state).

**Warning:** In case of a warning the "M2-Output — Switch" is activated (ON, inverted initial state)

When "Warning" is activated, "Error" is simultaneously activated (see section "Error code").

**Default Status:** Defines the default status (OFF) of the "M2-Output — Alarm" as "Open" or "Closed". It depends on the alarm type (normally open or closed).

### **2) Switch:**

Activate the switch output.

**ON:** Switch output into the active state (inverted initial state).

**Note:** When the "Program" is started, the M1 segment settings have higher priority.

**Default Status:** Defines the initial state (OFF) of the switch output as "Open" or "Closed". It depends on the switch type (normally open or closed).

## **3. M3-Input:**

### **1) Ext. Standby:**

External standby input to stop the device functions Temper and Pump.

**ON:** Activate the ext. standby function. Device functions are stopped in the event of an inverted initial state (ON) at the input.

**Default Status:** Define the default status (OFF) of the input as "Open" (high level) or "Closed" (low level).



## **OUTGAS**

In the option, the user is allowed to set the outgas speed in range of 1000 rpm to 4600 rpm and outgas interval from 10 seconds to 240 seconds.

This function can be used when filling external devices such as laboratory reactors.



## SAFETY

### **1. Time out:**

#### **1) Set:**

In the menu "Set", the user can determine a time limit in the event of a communication breakdown between the station and the **WiCo**. The station continues to work with the preset target values until the preset time value has expired. Following that, the station runs using the preset safety temperature and safety speed.

**Note:** The initial time out is 30 seconds and the user can define up to 60 minutes for this time limit.

#### **2) Speed:**

In the "Speed" menu, the user can specify a appropriate and safe speed for specified temperature.

**Note:** The factory setting of the safe speed is 1000 rpm and is activated after the time limit is set (see "Set").

#### **3) Temperature:**

In the "Temperature" menu, the user can specify a temperature that is appropriate and safe for the circulating task.

**Note:** The initial safe temperature is 30 °C and is activated after the time limit is set (see "Set").

### **2. Password:**

In the "Password" menu, the menu settings can be locked by a 3-digit password.



## SETTING

### **1. Languages:**

The "Language" option allows the user to select the desired language.

### **2. Display:**

The "Display" option allows the user to change the background color and brightness of the working screen.

### **3. Sound:**

The "Sound" option allows the user to activate/deactivate the key tone.

### **4. Factory Settings:**

Select the "Factory settings" option by turning and pressing the rotary/push knob. The system requests confirmation to restore the factory settings. Pressing the "OK" button resets all the system settings to the original standard values set at dispatch from the factory (see "Menu structure").

### **5. Communication:**

The "Device name" menu option allows you to edit the device name. This can relatively identify the paired station. The "Bluetooth®" menu option allows you to activate/deactivate the "Bluetooth®" function. A check mark shows that the option is activated.

### **6. Information:**

The "Information" option offers the user an overview of the most important system settings of the device.

## Interface and output

The device can be connected to a PC and operated with the laboratory software *labworldsoft®* through the RS 232 port, USB port or USB port on the **WiCo**.

**Note:** Please observe the system requirements together with the operating instructions and help section included with the software.

### **USB interface:**

The Universal Serial Bus (USB) is a serial bus for connecting the device to the PC. Equipped with USB devices can be connected to a PC during operation (hot plugging). Connected devices and their properties are automatically recognized. Use the USB interface in conjunction with *labworldsoft®* for operation in "Remote" mode and also to update the firmware.

### **USB device drivers:**

First, download the latest driver for **IKA** devices with USB interface from:

<http://www.ika.com/ika/lws/download/usb-driver.zip>.

Install the driver by running the setup file. Then connect the **IKA** device through the USB data cable to the PC.

The data communication is via a virtual COM port. Configuration, command syntax and commands of the virtual COM ports are as described in RS 232 port .

### **Device software update:**

For device software update, visit **IKA** website **www.ika.com** and enter the "Service" menu. Download and run the Firmware Update Tool.

Find and click the Firmware Update Tool in your PC after installation. Register your E-mail and password.

Connect the device to your PC via the USB cable. Then, you can update the device software according to instructions of the Firmware Update Tool.

### **RS 232 interface:**

Configuration

- The functions of the interface connections between the stirrer machine and the automation system are chosen from the signals specified in EIA standard RS 232 in accordance with DIN 66 020 Part 1.
- For the electrical characteristics of the interface and the allocation of signal status, standard RS 232 applies in accordance with DIN 66 259 Part 1.
- Transmission procedure: asynchronous character transmission in start-stop mode.
- Type of transmission: full duplex.
- Character format: character representation in accordance with data format in DIN 66 022 for start-stop mode. 1 start bit; 7 character bits; 1 parity bit (even); 1 stop bit.
- Transmission speed: 9600 bit/s.
- Data flow control: none
- Access procedure: data transfer from the stirrer machine to the computer takes place only at the computer's request.

### **Command syntax and format:**

The following applies to the command set:

- Commands are generally sent from the computer (Master) to the device (Slave).
- The device sends only at the computer's request. Even fault indications cannot be sent spontaneously from the device to the computer (automation system).
- Commands are transmitted in capital letters.
- Commands and parameters including successive parameters are separated by at least one space (Code: hex 0x20).
- Each individual command (incl. parameters and data) and each response are terminated with Blank CR LF (Code: hex 0x0d hex 0x0A) and have a maximum length of 80 characters.
- The decimal separator in a number is a dot (Code: hex 0x2E).

The above details correspond as far as possible to the recommendations of the NAMUR working party (NAMUR recommendations for the design of electrical plug connections for analogue and digital signal transmission on individual items of laboratory control equipment, rev. 1.1).

The NAMUR commands and the additional specific **IKA** commands serve only as low level commands for communication between the device and the PC. With a suitable terminal or communications programme these commands can be transmitted directly to the circulator equipment. The **IKA** software package, *Labworldsoft®*, provides a convenient tool for controlling circulating equipment and collecting data under MS Windows, and includes graphical entry features, for pump motor speed ramps for example.

### **Commands:**

Commands	Function
IN_PV_1	Read the external actual temperature
IN_PV_2	Read the internal actual temperature
IN_PV_4	Read the pump actual speed
IN_SP_1	Read the internal setting temperature (if 0: internal control) Read the external setting temperature (if 1: external control)
IN_SP_4	Read the pump setting speed



IN_TMODE	Read temperature control: (0: internal control) (1: external control)
OUT_SP_1 xxx	Set the internal setting temperature XXX (if 0: internal control) Set the external setting temperature XXX (if 1: external control)
OUT_SP_12@n	Set the WD safety temperature with echo of the set (defined) value.
OUT_SP_4 xxx	Set the pump speed XXX
OUT_SP_42@n	Set the WD-safety speed with echo of the set (defined) value.
OUT_TMODE_0	Set to internal temperature control
OUT_TMODE_1	Set to external temperature control
OUT_WD1@n	Start the watchdog mode 1 and set the time for the watchdog to n (20...1500) seconds. Echo of the Watchdog time. During a WD1-event, the cooling and pump functions are switched off and message PC 1 is display. This command needs to be send within the watchdog time.
OUT_WD2@n	Start the watchdog mode 2 and set the watchdog time to n (20...1500) seconds. Echo of the watchdog time. During a WD2-event, the set temperature is changed to the WD safety temperature and the pump set speed is set to the WD safety speed. The PC 2 warning is displayed. This command needs to be send within the watchdog time.
RESET	Reset the PC control and stop the device functions.
START_1	Start the tempering function
START_4	Start the pump function
STOP_1	Stop the tempering function
STOP_4	Stop the pump function

### Connections between device and external devices:

#### PC 1.1 Cable:

This cable is required to connect RS 232 port to a PC.

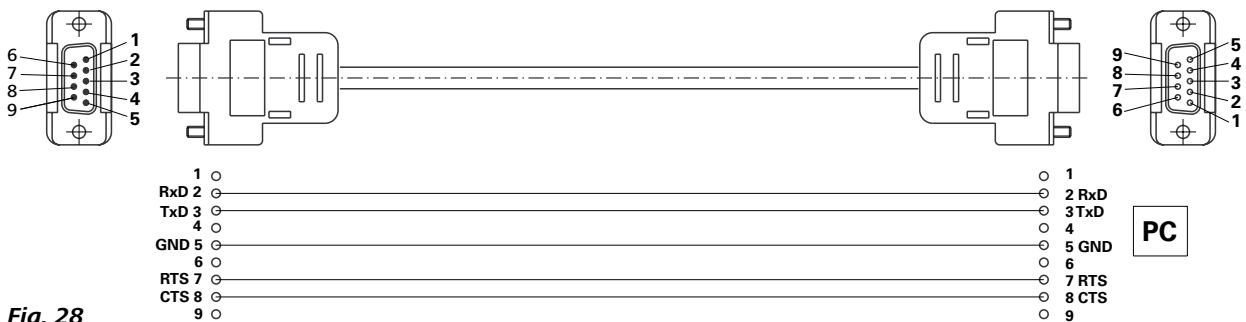

Fig. 28

#### USB 2.0 Cable A - micro B:

This cable is required to connect USB port to a PC.

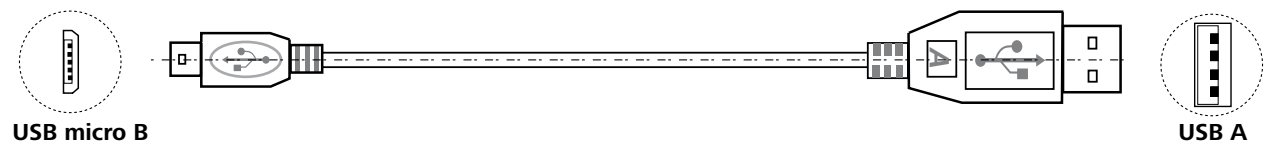

Fig. 29

#### USB 2.0 cable micro A - micro B:

This cable is required to connect **WiCo** to **station**.

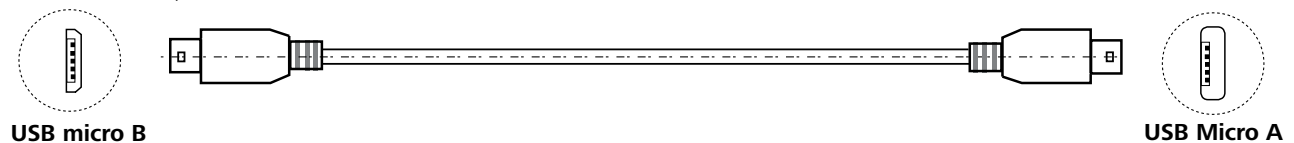
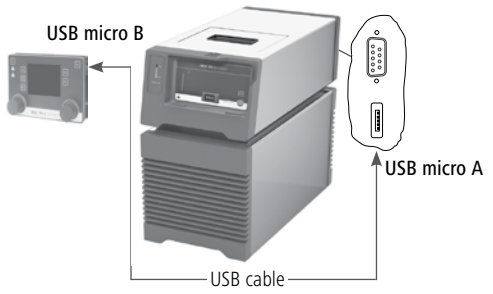

Fig. 30



Connection **WiCo** to **station**:



**Fig. 31**

Connection the device to PC:

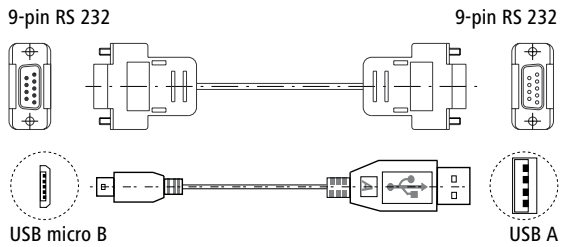
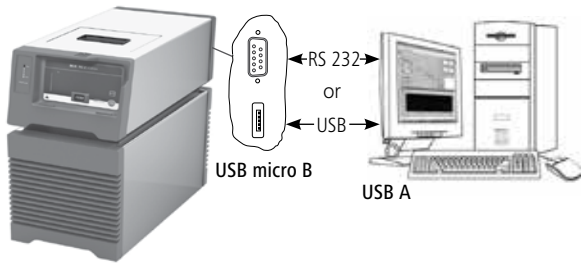
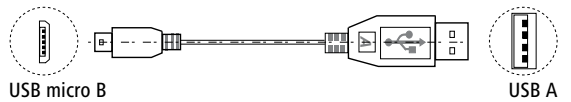
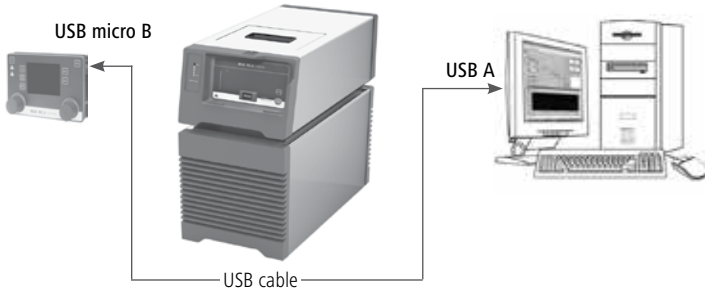
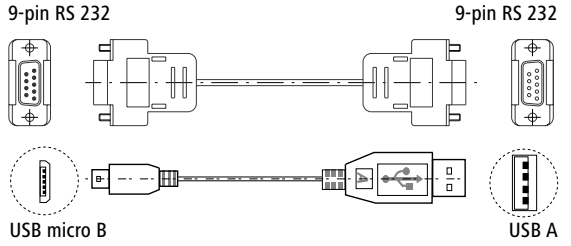
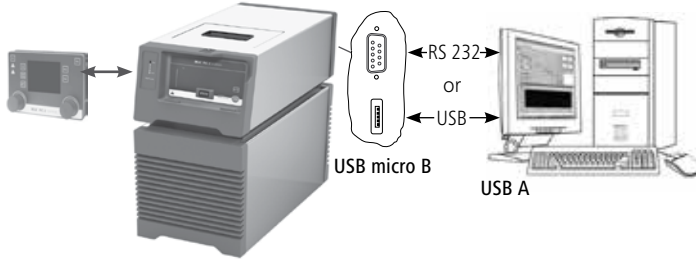

**Fig. 32**

Multifunction interface:

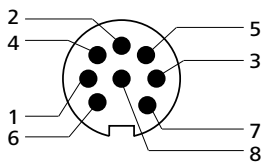

- 1 M1 Output Valve + (+24Vdc/max. 0.8A)
- 2 M1 Output Valve -
- 3 M2 Output Alarm/Switch 1 (max. 30Vdc/ac/max. 1A)
- 4 M2 Output Alarm/Switch 2
- 5 M3 Input standby + (+5V ca. 10mA)
- 6 M3 Input standby - (0V only for Standby)
- 7 --- (reserved for later use, do not connect!)
- 8 --- (reserved for later use, do not connect!)

**Fig. 33**

## Maintenance and cleaning

To avoid contamination, it is essential to check and change the bath fluid from regularly.

If water is used for bath fluid, we recommend to add Water bath protective media. The protective media stops the growth of algae, bacteria and other microorganisms.

To maintain the full cooling performance, maintain the condenser dust filter from time to time.

- Switch off the device and disconnect power cable.
- Open the front venting grid.
- Take out the dust filter.
- Clean condenser dust filter with a vacuum cleaner or wash the filter in the water and dry the it before assembly.

**Note:** Don't touch the heating exchanger surface with hard parts.

### **Cleaning:**

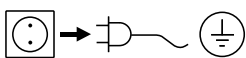

Disconnect main plug prior to cleaning!

Use only cleaning agents which have been approved by **IKA** to clean the device: Water containing surfactant / isopropyl alcohol.

- Wear protective gloves while cleaning the instruments.
- Electrical instruments may not be placed in the cleansing agent for the purpose of cleaning.
- Do not allow moisture to get into the instrument when cleaning.
- Before using another than the recommended method for cleaning or decontamination, the user must ascertain with **IKA** that this method does not damage the instrument.

### **Spare parts order:**

When ordering spare parts, please give:

- machine type
- serial number, see type plate
- item and designation of the spare part, see [www.ika.com](http://www.ika.com), spare parts diagram and spare parts list
- Software version.

### **Repair:**

**Please send in instrument for repair only after it has been cleaned and is free from any materials which may constitute a health hazard.**

For repair, please request the "Decontamination Certificate" from **IKA**, or download printout of it from the **IKA** website [www.ika.com](http://www.ika.com).

If you require servicing, return the instrument in its original packaging. Storage packaging is not sufficient. Please also use suitable transport packaging.

## Error codes

Any malfunctions during operation will be identified by an error message on the display.

Proceed as follows in such cases:

- ☞ Switch off device using the main switch at the back of the device.
- ☞ Carry out corrective measures.
- ☞ Restart device.

Error code	Effect	Cause	Solution
<b>Error 01</b>	Pump off Refrigerating off	No external temperature sensor	- Check this sensor
<b>Error 02</b>	Pump off Refrigerating off	Motor over current (rate current)	- Reduce pump motor speed - Use fluid with lower viscosity - Check if the pump impeller is blocked
<b>Error 04</b>	Pump off Refrigerating off	Motor hall signal missing	- Reduce pump motor speed - Use fluid with lower viscosity - Check if the pump impeller is blocked
<b>Error 06</b>	Pump off Refrigerating off	Too low liquid level	- Check the liquid level and buoyage
<b>Error 10</b>	Pump off Refrigerating off	PC communication failure	- Check communication cable
<b>Error 15</b>	Pump off Refrigerating off	Compressor power supply disconnected	- Restart the device
<b>Error 16</b>	Pump off Refrigerating off	Suction temperature error	- Restart the device
<b>Error 17</b>	Pump off Refrigerating off	Discharge temperature error	- Restart the device
<b>Error 19</b>	Pump off Refrigerating off	Fluid temperature too high	- Switch the device off and let the fluid cool down
<b>Error 20</b>	Pump off Refrigerating off	Condenser fan error	- Restart the device

Warning message	Effect	Cause	Solution
<b>High fluid level warning</b>	Warning message and high level icon appear	Too high fluid level	- Check the fluid level and buoyage - Drain excess fluid from bath.
<b>Low fluid level warning</b>	Warning message and low level icon appear	Too low fluid level	- Check the fluid level and buoyage - Add more fluid to bath.

**Note:** When the cooling function is not activated, the screen show only these warning information if fluid level is too high or too low.

When the cooling function is activated, if the fluid level goes slowly up/down to the warning level, the screen show high/low fluid level warning message and icon.

If the fluid level is corrected, the warning message and high/low level icon disappear.

After low fluid level warning, if the fluid level decreases further, the screen show Error 6.

If the actions described fails to resolve the fault or another error code is displayed then take one of the following steps:

- Contact the service department
- Send the device for repair, including a short description of the fault.

## Accessories

### **Tubing, hoses, adapters and couplings:**

<b>LT 5.20</b>	Metal hose (isolated M16 x 1)
<b>LT 5.21</b>	PTFE hose (isolated M16 x 1)
<b>H.PVC.8</b>	PVC hose (nominal width 8)
<b>H.PVC.12</b>	PVC hose (nominal width 12)
<b>H.SI.8</b>	Silicone hose (nominal width 8)
<b>H.SI.12</b>	Silicone hose (nominal width 12)
<b>H.PUR.8</b>	PUR tube (nominal width 8 mm)
<b>H.PUR.12</b>	PUR tube (nominal width 12 mm)
<b>H.FKM.8</b>	FKM tube (nominal width 8 mm)
<b>H.FKM.12</b>	FKM tube (nominal width 12 mm)

### **Tubing Insulations:**

<b>ISO. 8</b>	Insulation (8 mm)
<b>ISO.12</b>	Insulation (12 mm)

### **Valve:**

<b>MV 1</b>	Magnetic valve
<b>CO V 1</b>	Closed pressure valve

### **Additional accessories:**

<b>PC 1.1</b>	Cable (RS 232)
---------------	----------------

**Labworldsoft®**

See more accessories on [www.ika.com](http://www.ika.com).

## Technical data

Nominal voltage	<b>VAC</b>	230 ± 10% 100 ... 115 ± 10%
Frequency	<b>Hz</b>	50 / 60
Max. input power	<b>W</b>	1100
Working temperature range	<b>°C</b>	- 30 ... RT
Operating temperature range (with external heating)	<b>°C</b>	- 30 ... + 80
Temperature stability – internal temperature control (according to DIN 12876)	<b>K</b>	± 0.1
Temperature control		PID (Automatic / user setting)
Temperature measurement, absolute accuracy Internal (int) (adjustable by calibration) External (ext) (adjustable by calibration)	<b>K</b>	± 0.5 ± 0.5
External Pt 100.3 temperature sensor tolerance to DIN EN 60751 class A, $\leq \pm (0.15 + 0.002 \times  T )$ , e.g. at max. 100°C (adjustable by calibration)	<b>K</b>	± 0.35 (at 100°C)
Temperature setting		Knob on <b>WiCo</b>
Temperature setting resolution	<b>K</b>	0.1
Temperature display		TFT LCD on <b>WiCo</b>
Temperature display resolution	<b>K</b>	0.01
Cooling capacity according to DIN 12876 (at 4600 rpm): + 20 °C + 10 °C 0 °C - 10 °C - 20 °C - 30 °C	<b>W</b>	1400 1200 950 650 450 200
Refrigerant		R 290 <b>ⓘ</b>
Refrigerant quantity	<b>g</b>	90
Max. refrigerating system pressure	<b>bar</b>	21
Pump speed (adjustable)	<b>rpm</b>	1000...4600
Max. pump pressure/suction	<b>bar</b>	0.61 / 0.45
Max. flow rate (at 0 bar)	<b>l/min</b>	31
Bath volume	<b>l</b>	5 ... 7
Fluid maximum viscosity	<b>mm²/s</b>	50
Low level protection		Yes
Interface		USB, RS 232, multi-function interface
Permitted on-time	<b>%</b>	100
IP code according to EN 60 529		IP 21
Protection class		I
Excess voltage category		II
Contamination level		2
Permitted ambient temperature	<b>°C</b>	+ 5 ... + 32
Permitted ambient humidity	<b>%</b>	80
Dimension (W x D x H)	<b>mm</b>	310 x 490 x 546
Weight	<b>kg</b>	37.8
Operation at a terrestrial altitude	<b>m</b>	max. 2000

<b>WiCo</b>		
Permitted on time	<b>%</b>	100
Max. communication distance (dependent on the building)	<b>m</b>	15
Dimensions (W x D x H)	<b>mm</b>	160 x 40 x 105
Weight	<b>kg</b>	0.3
Ambient temperature	<b>°C</b>	+ 5 ... + 40
Ambient humidity (relative)	<b>%</b>	80
IP code according to EN 60 529		IP 40
Interface		USB

#### **RB 1 Battery pack**

Voltage	<b>V</b>	3.7
Charging capacity	<b>mAh</b>	2000
Charging time	<b>h</b>	4.5
Working time	<b>h</b>	15
Battery type		Lithium-polymer

● **Note:** Refrigerant must be disposed of in accordance with local and national regulations.

*Subject to technical changes!*

## Warranty

In accordance with **IKA** warranty conditions, the warranty period is 24 months. For claims under the warranty please contact your local dealer. You may also send the machine direct to our factory, enclosing the delivery invoice and giving reasons for the claim. You will be liable for freight costs.

The warranty does not cover worn out parts, nor does it apply to faults resulting from improper use, insufficient care or maintenance not carried out in accordance with the instructions in this operating manual.

## Pump performance curve

### Pump performance curve measured with water:

(Measurements done according DIN 12876-2 with water at 20°C; pump in a closed-loop circuit).

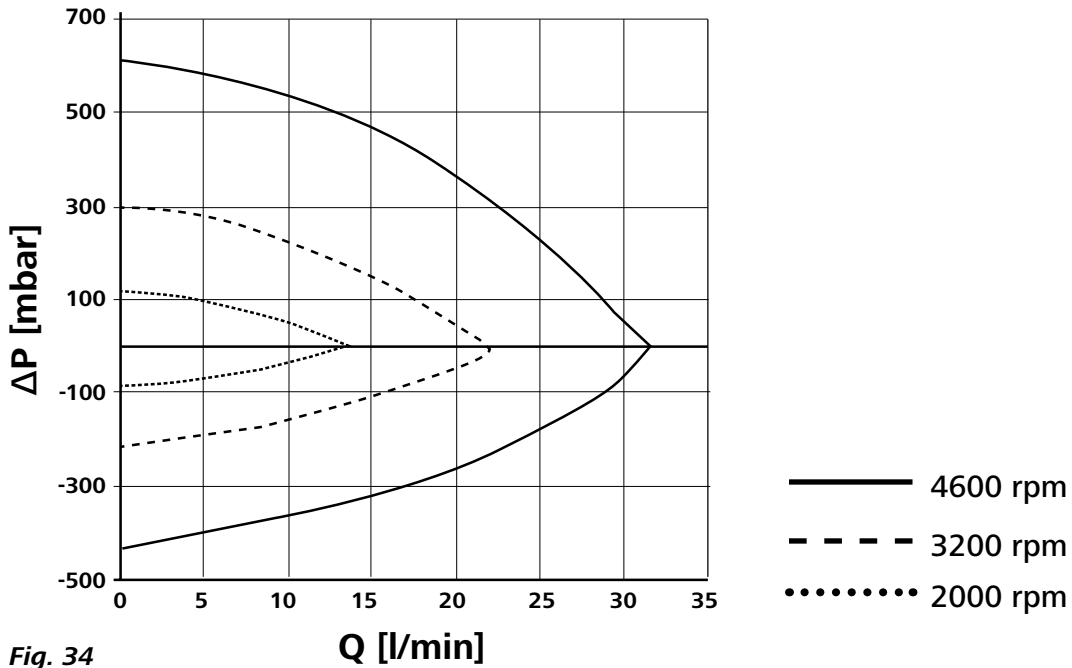

Fig. 34



designed for scientists

---

**IKA-Werke GmbH & Co. KG**

Janke & Kunkel-Straße 10, 79219 Staufen, Germany

Phone: +49 7633 831-0, Fax: +49 7633 831-98

eMail: sales@ika.de

---

**USA**

**IKA Works, Inc.**

Phone: +1 910 452-7059

eMail: usa@ika.net

**KOREA**

**IKA Korea Ltd.**

Phone: +82 2 2136 6800

eMail: sales-lab@ika.kr

**BRAZIL**

**IKA Brazil**

Phone: +55 19 3772 9600

eMail: sales@ika.net.br

**MALAYSIA**

**IKA Works (Asia) Sdn Bhd**

Phone: +60 3 6099-5666

eMail: sales.lab@ika.my

**CHINA**

**IKA Works Guangzhou**

Phone: +86 20 8222 6771

eMail: info@ika.cn

**POLAND**

**IKA Poland Sp. z o.o.**

Phone: +48 22 201 99 79

eMail: sales.poland@ika.com

**JAPAN**

**IKA Japan K.K.**

Phone: +81 6 6730 6781

eMail: info\_japan@ika.ne.jp

**INDIA**

**IKA India Private Limited**

Phone: +91 80 26253 900

eMail: info@ika.in

**UNITED KINGDOM**

**IKA England LTD.**

Phone: +44 1865 986 162

eMail: sales.england@ika.com

**VIETNAM**

**IKA Vietnam Company Limited**

Phone: +84 28 38202142

eMail: sales.lab-vietnam@ika.com

---

Discover and order the fascinating products of IKA online:

**www.ika.com**

---



IKAworlwide



IKAworlwide /// #lookattheblue



@IKAworlwide

---