

Register your instrument!
www.eppendorf.com/myeppendorf



Centrifuge 5430/5430 R

Operating manual

Copyright© 2013 Eppendorf AG, Hamburg. No part of this publication may be reproduced without the prior permission of the copyright owner.

Trademarks

Eppendorf®, the Eppendorf logo, CombiSlide®, and QuickLock® are registered trademarks of Eppendorf AG, Hamburg, Germany.

Centriplus® is a registered trademark of Millipore Corporation, Billerica, USA.

Microtainer® is a registered trademark of Becton Dickinson, Franklin Lakes, NJ, USA.

Trademarks are not marked in all cases with ™ or ® in this manual.

Operating manual 3
Declarations and Certificates 69
Menu structure of Centrifuge 5430/5430 R 85
Rotor F-35-6-30: Adapters for round-bottom tubes and blood taking systems 86

Table of contents

1	Operating instructions	7
1.1	Using this manual	7
1.2	Danger symbols and danger levels	7
1.2.1	Danger symbols	7
1.2.2	Danger levels	7
1.3	Symbols used	7
1.4	Abbreviations used	8
2	Product description	9
2.1	Main illustration	9
2.2	Delivery package	10
2.2.1	Centrifuge 5430	10
2.2.2	Centrifuge 5430 R	10
2.3	Features	11
2.4	Rotors	12
2.4.1	rcf display and calculation	16
3	Safety	18
3.1	Intended use	18
3.2	User profile	18
3.3	Application limits	18
3.3.1	Declaration concerning the ATEX directive (94/9/EC)	18
3.3.2	Maximum service life for accessories	18
3.4	Information on product liability	20
3.5	Warnings for intended use	20
3.5.1	Personal injury or damage to the equipment	20
3.5.2	Incorrect handling of the centrifuge	21
3.5.3	Incorrect handling of the rotors	22
3.5.4	Extreme strain on the centrifuging tubes	23
3.5.5	Aerosol-tight centrifugation	24
3.6	Safety notes on the device	24
4	Installation	25
4.1	Selecting the location	25
4.2	Preparing installation	25
4.3	Installing the instrument	26
5	Operation	28
5.1	Overview of operating controls	28
5.2	Menu navigation	29
5.3	Configure centrifuge	30
5.3.1	Set menu language	30
5.3.2	Setting the date and time	30
5.4	Preparing for centrifugation	32
5.4.1	Switching on the centrifuge	32
5.4.2	Inserting the rotor	32
5.4.3	Automatic rotor detection	32
5.4.4	Manual rotor detection	32
5.4.5	Loading the rotor	33
5.4.6	Closing the centrifuge lid	35

5.5	Cooling (only 5430 R)	36
5.5.1	Temperature adjustment	36
5.5.2	Temperature display	36
5.5.3	Temperature monitoring	36
5.5.4	FastTemp	36
5.5.5	FastTemp pro	37
5.5.6	Continuous cooling	38
5.6	Centrifuging	39
5.6.1	Centrifugation with time setting	39
5.6.2	Centrifuging in continuous operation	40
5.6.3	Short-spin centrifugation	40
5.6.4	Removing the rotor	41
5.7	Standby mode	41
5.8	User instructions on rotors	42
5.8.1	Rotor F-35-6-30: rotor removal tool	42
5.8.2	Rotor A-2-MTP	43
5.8.3	Rotor FA-45-24-11-HS: using the special rotor key	43
5.8.4	QuickLock	44
6	Operating controls and function	45
6.1	Device menu	45
6.2	Settings in the device menu	47
6.2.1	Programs	47
6.2.2	Use program keys	47
6.2.3	Other menu items	48
6.2.4	Settings	49
7	Maintenance	50
7.1	Prepare cleaning/disinfection	50
7.2	Cleaning/disinfection	50
7.2.1	Cleaning and disinfecting the device	51
7.2.2	Cleaning and disinfecting the rotor	51
7.3	Additional service instructions for Centrifuge 5430 R	52
7.4	Glass breakage	53
7.5	Fuses	53
7.6	Decontamination before shipment	53
8	Troubleshooting	54
8.1	General errors	54
8.2	Error messages	55
8.3	Emergency release	57
9	Transport, storage and disposal	58
9.1	Transport	58
9.2	Storage	58
9.3	Disposal	58
10	Technical data	59
10.1	Power supply	59
10.2	Ambient conditions	59
10.3	Weight/dimensions	60
10.4	Application parameters	60

11	Ordering Information	62
11.1	Centrifuge 5430	62
11.2	Centrifuge 5430 R	62
11.3	Rotors, rotor lids and seals	63
11.3.1	Rotors with QuickLock rotor lid	63
11.3.2	Rotors with rotor lid thread	65
11.3.3	Rotors with rotor lid for attaching	67
11.4	Accessories	67
11.4.1	Adapter	67
11.4.2	Other accessories	68
11.4.3	Fuses for Centrifuge 5430	68

1 Operating instructions

1.1 Using this manual







- ▶ Read this operating manual completely before using the device for the first time. Please also note the operating instructions for the accessories, if applicable.
- ▶ This operating manual is part of the product. Thus, it must always be easily accessible.
- ▶ Enclose this operating manual when transferring the device to third parties.
- ▶ If this manual is lost, please request another one. For the current version, please refer to our webpage www.eppendorf.com (international) or www.eppendorfna.com (North America).

The Centrifuge 5430/5430 R is available in two versions: **key pad** or **rotary knobs**. This operating manual generally describes how to operate the keypad version but it also applies to the rotary knob version.

1.2 Danger symbols and danger levels

The safety instructions in this manual appear with the following danger symbols and danger levels:



1.2.1 Danger symbols

	Biohazard		Explosion
	Electric shock		Crushing
	Hazard point		Material damage

1.2.2 Danger levels

DANGER	<i>Will</i> lead to serious injuries or death.
WARNING	<i>May</i> lead to serious injuries or death.
CAUTION	May lead to light to moderate injuries.
NOTICE	May lead to material damage.

1.3 Symbols used

Example	Meaning
▶	You are requested to perform an action.
1. 2.	Perform these actions in the sequence described.
•	List.
	Press this key to perform the described action.
<i>Text</i>	Terms from the display of the device.
	References useful information.

1.4 Abbreviations used

MTP

Micro test plate

PCR

Polymerase chain reaction

PTFE

Polytetrafluorethylene

RZB/rcf

Relative centrifugal force – *g*-force in m/s^2

rpm

Revolutions per minute – in rpm

UV

Ultraviolet radiation

2 Product description

2.1 Main illustration

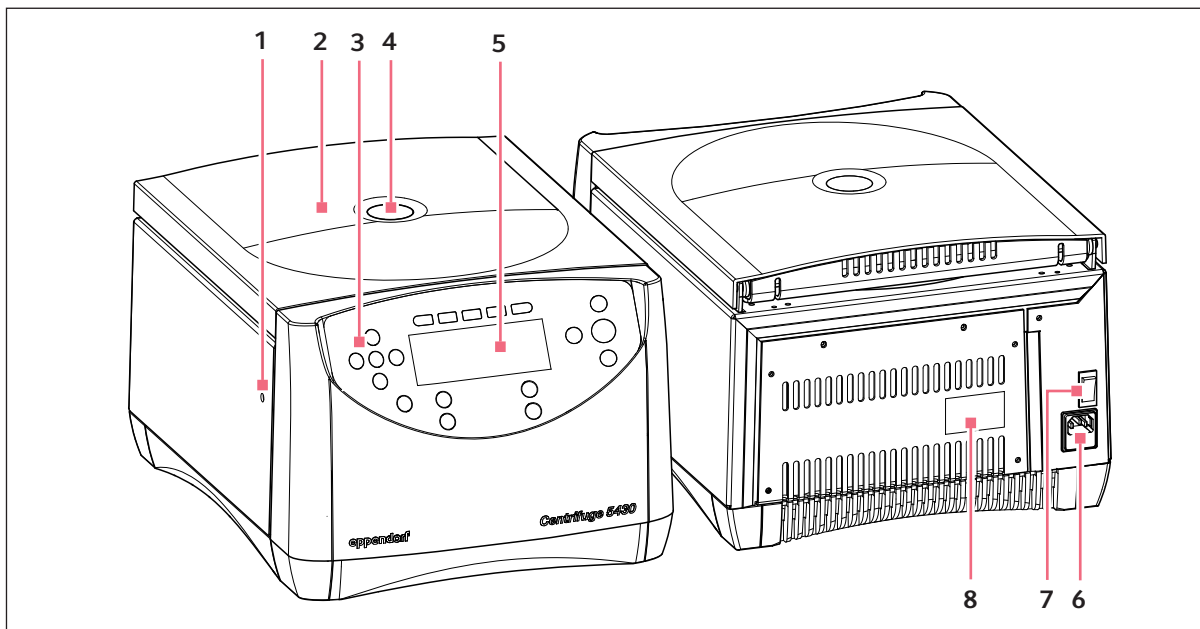

Fig. 2-1: Front and rear view of Centrifuge 5430

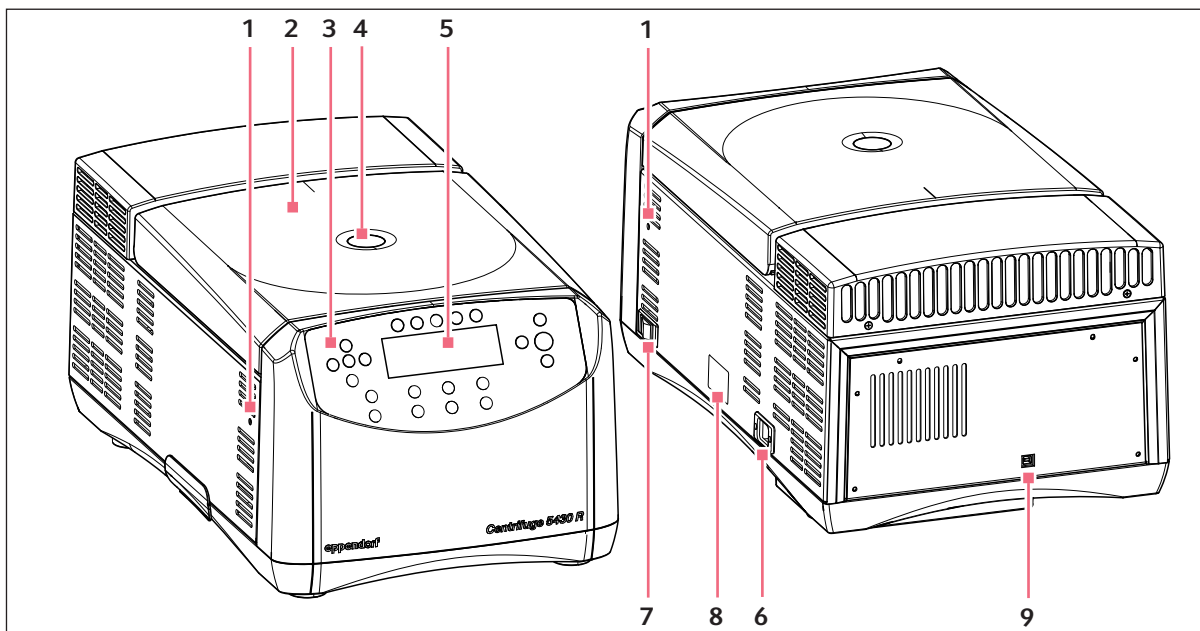

Fig. 2-2: Front and rear view of Centrifuge 5430 R

Product description

Centrifuge 5430/5430 R
English (EN)

1 Emergency lid release

On both sides of the device (see *Emergency release* on p. 57).

2 Centrifuge lid**3 Control panel**

Keys and dials (dependent on the device version) for operating the centrifuge (see p. 28).

4 Window

Visual control for rotor stop or option for speed check via stroboscope.

5 Display

Depiction of the current centrifuging parameters and device settings (see p. 28).

6 Mains connection

Connection socket for the mains cable supplied.
Only 5430: The fuse holder is located beneath (see *Fuses* on p. 53).

7 Mains switch

Switch for switching the device on and off.
Switch position 0: The device is switched off.
Switch position I: The device is switched on.

8 ID plate**9 USB port**

Interface for error analysis and software updates by the Technical Service.

2.2 Delivery package**2.2.1 Centrifuge 5430**

Quantity	Order no. (International)	Order no. (North America)	Description
1	–	–	Centrifuge 5430 See chapter <i>Ordering Information</i> for corresponding device version, equipment and order number
1 oder	5301 850.249 5427 850.341	022654403 022654381	Fuse 4 A (230 V), 2 pieces 8.0 AT UL (120 V/100 V), 2 pieces
1	5416 301.001	022634305	Rotor key Standard
1	–	–	Mains power cable
1	5427 901.124	5427901124	Operating manual Centrifuge 5430/5430 R Languages: EN, DE, FR, ES, IT, PT
1	5427 901.132	5427901132	Languages: DA, FI, EL, NL, SV (230 V devices only)

2.2.2 Centrifuge 5430 R

Quantity	Order no. (International)	Order no. (North America)	Description
1	–	–	Centrifuge 5430 R See chapter <i>Ordering Information</i> for corresponding device version, equipment and order number
1	5416 301.001	022634305	Rotor key Standard
1	–	–	Mains power cable
1	5427 901.124	5427901124	Operating manual Centrifuge 5430/5430 R Languages: EN, DE, FR, ES, IT, PT
1	5427 901.132	5427901132	Languages: DA, FI, EL, NL, SV (230 V devices only)

2.3 Features

The multifaceted Centrifuge 5430 has a capacity of 48 × 2.0 mL and reaches max. 30,130 × g/17,500 min⁻¹. The versatility is reflected in the available rotor options. You can select from 12 different rotors to centrifuge the following tubes for your various applications:

- Tubes (0.2 to 5.0 mL)
- PCR strips
- Microtainers
- Spin columns
- Cryo tubes
- Conical tubes (15/50 mL)
- Microplates
- PCR plates
- Deepwell plates (max. height 29 mm)
- Slides (with CombiSlide adapter)

Five program keys for rapid loading and saving of parameters, as well as another 45 program places, a large display and menu-controlled operation all make it easier to use the centrifuge. The Centrifuge 5430 has been designed based on latest ergonomic studies. This facilitates an intuitive and easy operation.



The Centrifuge 5430 is available with two different operator panels: one easy to clean keypad or blue rotary knobs to quickly set the centrifugation parameter.

The Centrifuge 5430 R has an additional temperature control function for centrifugation between -11°C and +40°C. The **Fast Temp** function is used to start a temperature control run without samples in order to quickly bring the rotor chamber, and rotor, bucket and adapter, to the set temperature. This temperature control cycle can also be started automatically at specified times using the **Fast Temp pro** function.

2.4 Rotors

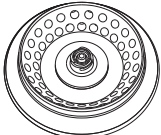
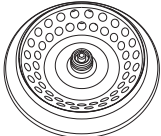
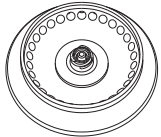
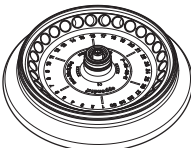
The Centrifuge 5430/5430 R can be operated with the following rotors. Before using tubes, observe the manufacturer's recommended specifications on resistance to centrifugation (max. g-force).

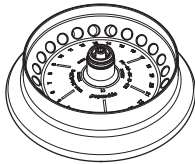
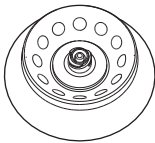
	Max. capacity	Max. g-force (rcf)/speed (rpm) without adapter	Max. load per rotor bore ⁽¹⁾	Notes
		Acceleration/ deceleration time ⁽²⁾ (soft): with soft ramp		
Rotor FA-45-48-11 With aerosol-tight QuickLock rotor lid 	48 tubes 1.5/2.0 mL. With adapters: <ul style="list-style-type: none"> • 0.2 mL PCR tubes • 0.4 mL tubes • 0.5 mL tubes • 0.6 mL Microtainer 	Outer ring: 18,213 × g Inner ring: 16,048 × g/ 12,700 rpm	3.75 g	<ul style="list-style-type: none"> • Aerosol-tight⁽³⁾ QuickLock rotor lid (aluminum).
		≤ 20 s/20 s ≤ 61 s/65 s (soft)		
Rotor F-45-48-11 With polypropylene rotor lid 	48 tubes 1.5/2.0 mL. With adapters: <ul style="list-style-type: none"> • 0.2 mL PCR tubes • 0.4 mL tubes • 0.5 mL tubes • 0.6 mL Microtainer 	Outer ring: 18,213 × g Inner ring: 16,048 × g/ 12,700 rpm	3.75 g	
		≤ 20 s/20 s ≤ 61 s/65 s (soft)		
Rotor FA-45-30-11 With aerosol-tight QuickLock rotor lid 	30 tubes 1.5/2.0 mL. With adapters: <ul style="list-style-type: none"> • 0.2 mL PCR tubes • 0.4 mL tubes • 0.5 mL tubes • 0.6 mL Microtainer 	20,817 × g/ 14,000 rpm	3.75 g	<ul style="list-style-type: none"> • Aerosol-tight⁽³⁾ QuickLock rotor lid (aluminum). • PTFE-coated (particularly resistant to chemicals), marked: <i>coated</i> • Spin columns available, better with rotor FA-45-24-11-kit.
		≤ 15 s/15 s ≤ 61 s/65 s (soft)		
Rotor F-45-30-11 With polypropylene rotor lid 	30 tubes 1.5/2.0 mL. With adapters: <ul style="list-style-type: none"> • 0.2 mL PCR tubes • 0.4 mL tubes • 0.5 mL tubes • 0.6 mL Microtainer 	20,817 × g/ 14,000 rpm	3.75 g	
		≤ 15 s/15 s ≤ 61 s/65 s (soft)		

	Max. capacity	Max. g-force (rcf)/speed (rpm) without adapter	Max. load per rotor bore ⁽¹⁾	Notes
		Acceleration/ deceleration time ⁽²⁾ (soft): with soft ramp		
Rotor FA-45-24-11-Kit With aerosol-tight QuickLock rotor lid 	24 spin columns or 1.5/2.0 mL tubes. With adapters: <ul style="list-style-type: none"> • 0.2 mL PCR tubes • 0.4 mL tubes • 0.5 mL tubes • 0.6 mL Microtainer 	19,090 × g/ 13,200 rpm	3.75 g	<ul style="list-style-type: none"> • Aerosol-tight⁽³⁾ QuickLock rotor lid (aluminum). • Uniquely high edge, for all commercial spin columns. Also observe the note on centrifugation with open tube lids (see <i>Fixed-angle rotors on p. 33</i>)
		≤ 15 s/16 s ≤ 78 s/90 s (soft)		
Rotor FA-45-16-17 With aerosol-tight QuickLock rotor lid 	16 tubes 5.0 mL.	21,191 × g/ 14,200 rpm	9.5 g	<ul style="list-style-type: none"> • Aerosol-tight⁽³⁾ QuickLock rotor lid (aluminum).
		≤ 20 s/20 s ≤ 61 s/66 s (soft)		
Rotor S-24-11-AT With aerosol-tight QuickLock rotor lid 	24 tubes 1.5/2.0 mL. This rotor exclusively is to be used with 1.5/2.0 mL reaction vessels. Spin Columns and the adapters including the corresponding 0.2 mL, 0.4 mL, 0.5 mL and 0.6 mL vessels must not be used in this rotor.	16,049 × g/ 12,700 rpm	3.75 g	<ul style="list-style-type: none"> • Aerosol-tight⁽³⁾ QuickLock rotor lid (aluminum). • The rotor must always be operated with a rotor lid.
		≤ 13 s/16 s ≤ 61 s/66 s (soft)		

Product description

Centrifuge 5430/5430 R
English (EN)

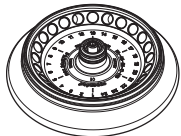
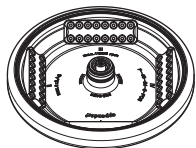
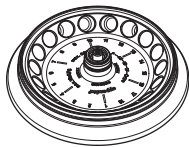
	Max. capacity	Max. g-force (rcf)/speed (rpm) without adapter	Max. load per rotor bore ⁽¹⁾	Notes
		Acceleration/ deceleration time ⁽²⁾ (soft): with soft ramp		
Rotor FA-45-24-11-HS 	24 tubes 1.5/2.0 mL. With adapters: <ul style="list-style-type: none"> • 0.2 mL PCR tubes • 0.4 mL tubes • 0.5 mL tubes • 0.6 mL Microtainer 	30,130 × g/ 17,500 rpm	3.75 g	<ul style="list-style-type: none"> • Aerosol-tight⁽³⁾ rotor lid (aluminum). • Max. g-force/speed (30,130 × g/17,500 rpm) only with tubes approved by the manufacturer for this speed. • PTFE-coated (particularly resistant to chemicals), marked: <i>coated</i> • Spin columns available, better with rotor FA-45-24-11-kit. • The rotor can only be tightened and loosened using the special rotor key for rotor FA-45-24-11-HS (see p. 42).
		≤ 21 s/16 s ≤ 61 s/65 s (soft)		
Rotor F-45-64-5-PCR 	64 PCR tubes (0.2 mL) or eight 5-tube or 8-tube PCR strips, each with the enclosed adapters.	13,543 × g/ 11,800 rpm	3.4 g (without adapter)	
		≤ 12 s/15 s ≤ 62 s/65 s (soft)		
Rotor F-45-18-17-Cryo 	18 Cryo tubes or 18 sealable centrifugation tubes, max. Ø: 16.9 mm. With supplied adapters: max. Ø: 13.4 mm, max. tube length: 50 mm.	8,324 × g/ 8,900 rpm	8.7 g	<ul style="list-style-type: none"> • Setting the g-force/speed in increments of 10 × g or 10 rpm.
		≤ 8 s/11 s ≤ 77 s/85 s (soft)		

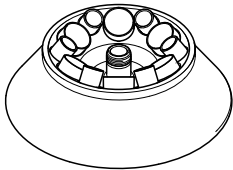
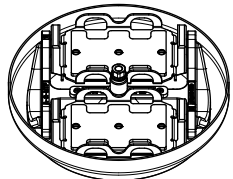
	Max. capacity	Max. g-force (rcf)/speed (rpm) without adapter	Max. load per rotor bore ⁽¹⁾	Notes
		Acceleration/ deceleration time ⁽²⁾ (soft): with soft ramp		
Rotor F-35-6-30 	6 conical tubes 50 mL, with or without skirted bottom or 6 conical tubes 15 mL, with enclosed adapters or 6 Centriplus centrifuge filter units with adapters.	7,745 × g/ 7,830 rpm	110 g	<ul style="list-style-type: none"> The rotor can only be removed and inserted using the supplied removal tool. Centrifugation of round-bottom tubes and blood taking systems can be completed using additional adapters (see p. 86).
		≤ 23 s/23 s ≤ 62 s/67 s (soft)		
Rotor A-2-MTP 	Two buckets to hold: <ul style="list-style-type: none"> • Microplates • Cell culture plates • PCR plates • Deepwell plates (max. height 29 mm) • Slide (with CombiSlide adapter) 	2,204 × g/ 4,680 rpm	170 g (per bucket)	<ul style="list-style-type: none"> • PCR plates can only be centrifuged with appropriate adapters. • Max. loading height: 29 mm. • Only 5430 R: More efficient cooling via centrifugation without wind shield upper shell (see <i>Swing-bucket rotor</i> on p. 34).
		≤ 18 s/21 s ≤ 63 s/67 s (soft)		

(1) Maximum load per rotor bore for adapter + tube + contents.

(2) According to DIN 58 970 (device versions: 230 V, 120 V and 100 V, 50 to 60 Hz).

(3) Aerosol tightness tested and certified by the Centre of Emergency Preparedness and Response, Health Protection Agency, Porton Down (UK) (see certificates at the end of this operating manual).

For the rotors and rotor lids labeled *coated*, color fluctuations may occur as a result of the production process. These fluctuations have no effect on service life or resistance to chemicals.

Rotor code:

All Eppendorf® rotors are identified using a simple, alphanumeric format that represents the technical specifications in a uniform series of letters and numbers.

<table border="0"> <tr> <td>Fixed-angle rotor</td> <td>Angle of bores</td> <td>∅ of bores (mm)</td> </tr> <tr> <td>F</td> <td>A</td> <td>45</td> </tr> <tr> <td colspan="2">Aerosol-tight version</td> <td>Number of bores</td> </tr> <tr> <td colspan="2"></td> <td>30</td> </tr> <tr> <td colspan="2"></td> <td>11</td> </tr> </table>	Fixed-angle rotor	Angle of bores	∅ of bores (mm)	F	A	45	Aerosol-tight version		Number of bores			30			11	<table border="0"> <tr> <td>Swing-bucket rotor</td> <td>∅ of bores (mm)</td> </tr> <tr> <td>S</td> <td>24</td> </tr> <tr> <td>Number of bores</td> <td>Aerosol-tight version</td> </tr> <tr> <td></td> <td>11</td> </tr> <tr> <td></td> <td>AT</td> </tr> </table>	Swing-bucket rotor	∅ of bores (mm)	S	24	Number of bores	Aerosol-tight version		11		AT
Fixed-angle rotor	Angle of bores	∅ of bores (mm)																								
F	A	45																								
Aerosol-tight version		Number of bores																								
		30																								
		11																								
Swing-bucket rotor	∅ of bores (mm)																									
S	24																									
Number of bores	Aerosol-tight version																									
	11																									
	AT																									

2.4.1 rcf display and calculation



Use the **rpm/rcf** key to switch the speed of centrifugation display from **rpm** to **g-force** (rcf). Ensure that the g-force displayed during switching is standardized to suit the rotor in question without an adapter. When adapters are used, the following maximum g-forces (rcf) can be achieved at maximum speed:

Rotor	Adapter	Max.centrifugation radius r_{\max} [cm]	Max. g-force (rcf)
Rotor FA-45-48-11/ Rotor F-45-48-11	Without adapter	Outer ring: 10.1 Inner ring: 8.9	Outer ring: 18,210 Inner ring: 16,048
	For 0.2 mL PCR tubes	Outer ring: 8 Inner ring: 6.8	Outer ring: 14,425 Inner ring: 12,261
	For 0.4 mL tubes	Outer ring: 10.1 Inner ring: 8.9	Outer ring: 18,210 Inner ring: 16,048
	For 0.5 mL tubes	Outer ring: 9 Inner ring: 7.8	Outer ring: 16,229 Inner ring: 14,065
	For 0.6 mL Microtainer	Outer ring: 10.1 Inner ring: 8.9	Outer ring: 18,210 Inner ring: 16,048
Rotor FA-45-30-11/ Rotor F-45-30-11	Without adapter	9.5	20,871
	For 0.2 mL PCR tubes	7.4	16,215
	For 0.4 mL tubes	9.5	20,871
	For 0.5 mL tubes	8.4	18,407
	For 0.6 mL Microtainer	9.5	20,817
Rotor FA-45-24-11-Kit	Without adapter	9.8	19,090
	For 0.2 mL PCR tubes	7.7	15,000
	For 0.4 mL tubes	9.8	19,090
	For 0.5 mL tubes	8.7	16,950
	For 0.6 mL Microtainer	9.8	19,090
Rotor FA-45-16-17	For 5.0 mL micro test tubes	9.4	21,191
Rotor S-24-11-AT	Without adapter	8.9	16,049
Rotor FA-45-24-11-HS	Without adapter	8.8	30,130
	For 0.2 mL PCR tubes	6.7	22,940
	For 0.4 mL tubes	8.8	30,130
	For 0.5 mL tubes	7.7	26,364
	For 0.6 mL Microtainer	8.8	30,130
Rotor F-45-64-5-PCR	For PCR strips, inside	7.7	11,987
	For PCR strips, outside	8.7	13,543
Rotor F-45-18-17-Cryo	Without adapter	9.4	8,320
	For Cryo tubes	9.0	7,970

Rotor	Adapter	Max.centrifugation radius r_{\max} [cm]	Max. g-force (rcf)
Rotor F-35-6-30*	For 15 mL conical tubes	11.0	7,540
	For 50 mL conical tubes	10.5	7,197
	for Centriplus centrifuge filter units	11.1	7,567
A-2-MTP rotor	Without adapter	9.0	2,204
	for 384 well PCR plates	7.7	1,885
	for 96 well PCR plates	7.3	1,788
	CombiSlide adapter	7.7	1,885

*) Centrifugation of round-bottom tubes and blood taking systems can be done using additional adapters (see p. 86).

To determine the g-force (rcf) for a special adapter, you can perform a calculation according to DIN 58 970 with the following formula:

$$\text{rcf} = 1.118 \cdot 10^{-5} \cdot n^2 \cdot r_{\max}$$

n: speed in min^{-1} (rpm)

r_{\max} : max. centrifuging radius in cm

Example:

In Rotor FA-45-30-11, the 0.5 mL adapter has a maximum radius of 8.4 cm. At 7,000 rpm, a maximum g-force of $4,600 \times g$ is achieved.

3 Safety

3.1 Intended use

The Centrifuge 5430/5430 R is intended exclusively for indoor use and for separating aqueous solutions and suspensions of various densities in approved test tubes.

3.2 User profile

This device may only be operated by trained specialist staff. They must have carefully read the operating manual and be familiar with the function of the device.

3.3 Application limits

3.3.1 Declaration concerning the ATEX directive (94/9/EC)



DANGER! Risk of explosion.

- ▶ Do not operate the device in areas where work is completed with explosive substances.
 - ▶ Do not use this device to process any explosive or highly reactive substances.
 - ▶ Do not use this device to process any substances which may generate an explosive atmosphere.
-

Due to its design and the environmental conditions inside the device, the Centrifuge 5430/5430 R is not suitable for use in a potentially explosive atmosphere.

The device only must be used in a safe environment, such as the open environment of a ventilated laboratory or fume hood. The use of substances which could create a potentially explosive atmosphere is not permitted. The final decision on the risks associated with the use of these types of substances is the responsibility of the user.

3.3.2 Maximum service life for accessories



WARNING! Risk of injury from chemically or mechanically damaged accessories.

Even minor scratches and cracks can lead to serious internal material damage.

- ▶ Protect all accessory parts from mechanical damage.
 - ▶ Inspect the accessories for damage before each use. Replace any damaged accessories.
 - ▶ Do not use rotors, rotor lids or buckets with signs of corrosion or mechanical damage (e.g., deformations).
 - ▶ Do not use any accessories whose maximum service life has been exceeded.
 - ▶ When inserting the buckets and rotors, ensure that they do not become scratched.
-



CAUTION! Risk of injury due to chemically damaged rotor lids or caps.

Transparent rotor lids or caps made from PC, PP or PEI may lose their strength under the impact of organic solvents (e.g., phenol, chloroform).

- ▶ If rotor lids or caps have come into contact with organic solvents, they should be cleaned immediately.
 - ▶ Regularly check the rotor lids and caps for damages and cracks.
 - ▶ Immediately replace rotor lids or caps that have cracks or milky stains.
-

The rotors listed below, and the corresponding buckets and rotor lids, have a maximum service life of the number of years or cycles listed in the table.

Since 2012, Eppendorf has been stating the maximum service life of the rotors and accessories both in years and in the maximum number of cycles. The decisive factor for the service life is which case occurs first, generally this is the number of years in operation.

Rotor	Maximum service from commissioning onward	
FA-45-48-11 (With QuickLock)	100,000 mechanical cycles	10 years
F-45-48-11 (With rotor lid thread)	100,000 mechanical cycles	10 years
FA-45-30-11 (With QuickLock)	100,000 mechanical cycles	10 years
FA-45-24-11-Kit (With QuickLock)	100,000 mechanical cycles	10 years
FA-45-16-17 (With QuickLock)	100,000 mechanical cycles	10 years
S-24-11-AT (With QuickLock)	100,000 mechanical cycles	10 years
A-2-MTP With the corresponding bucket and upper shell of the wind shield	100,000 mechanical cycles	7 years
QuickLock rotor lid	-	3 years
Rotor lid and caps made of polycarbonate (PC), polypropylene (PP) or polyetherimide (PEI)	-	3 years
Plastic adapters	-	1 year

For all other rotors and rotor lids of this centrifuge there is no service life limit as long as the following requirements are met:

- Proper use,
- Recommended maintenance
- Undamaged condition

The date of manufacture is stamped on the rotors in the format *03/10* (= March 2010) or on the inside of the plastic rotor lids in the form of a clock .

To ensure aerosol tightness, the following applies:

- Replace aerosol-tight rotor lids and caps after 50 autoclaving cycles.
- Replace the seal of QuickLock rotor lids after 50 autoclaving cycles.

3.4 Information on product liability

In the following cases, the designated protection of the device may be compromised. Liability for any resulting property damage or personal injury is then transferred to the operator:

- The device is not used in accordance with the operating manual.
- The device is used outside of its intended use.
- The device is used with accessories or consumables which are not recommended by Eppendorf.
- The device is maintained or repaired by people not authorized by Eppendorf.
- The user makes unauthorized changes to the device.

3.5 Warnings for intended use

Read the operating manual and observe the following general safety instructions before using the Centrifuge 5430/5430 R.

3.5.1 Personal injury or damage to the equipment



WARNING! Electric shock due to damage to device or mains cable.

- ▶ Only switch on the device if the device and mains cable are undamaged.
- ▶ Only use devices that have been properly installed or repaired.
- ▶ In case of danger, disconnect the device from the mains supply by pulling the power plug from the device or the mains socket or, by using the isolating device intended for this purpose (e.g. emergency stop switch in the laboratory).



WARNING! Lethal voltages inside the device.

- ▶ Ensure that the housing is always closed and undamaged so that no parts inside the device can be contacted by accident.
- ▶ Do not remove the housing of the device.
- ▶ Do not allow any liquids to penetrate the inside of the housing.
- ▶ Do not allow the device to be opened by anyone except service personnel who have been specifically authorized by Eppendorf.



WARNING! Risk from incorrect supply voltage

- ▶ Only connect the device to voltage sources which correspond to the electrical requirements on the name plate.
- ▶ Only use sockets with a protective earth (PE) conductor and suitable power cable.



WARNING! Damage to health due to infectious liquids and pathogenic germs.

- ▶ When handling infectious liquids and pathogenic germs, observe the national regulations, the biological security level of your laboratory, the material safety data sheets, and the manufacturer's application notes.
- ▶ Use aerosol tight sealing systems for the centrifugation of these substances.
- ▶ When working with pathogenic germs belonging to a higher risk group, more than one aerosol-tight bioseal must be used.
- ▶ Wear personal protective equipment.
- ▶ For full instructions regarding the handling of germs or biological material of risk group II or higher, please refer to the "Laboratory Biosafety Manual" (Source: World Health Organization, current edition of the Laboratory Biosafety Manual).



WARNING! Risk of injury when opening or closing the centrifuge lid.

There is a risk of crushing your fingers when opening or closing the centrifuge lid.

- ▶ When opening or closing the centrifuge lid, do not reach between the lid and device or into the latching mechanism of the lid.
- ▶ Always open the centrifuge lid completely to prevent it from falling.



CAUTION! Poor safety due to incorrect accessories and spare parts.

The use of accessories and spare parts other than those recommended by Eppendorf may impair the safety, functioning and precision of the device. Eppendorf cannot be held liable or accept any liability for damage resulting from the use of incorrect or non-recommended accessories and spare parts, or from the improper use of such equipment.

- ▶ Only use accessories and original spare parts recommended by Eppendorf.



NOTICE! Damage to device due to spilled liquids.

1. Switch off the device.
2. Disconnect the device from the power supply.
3. Carefully clean the device and the accessories in accordance with the cleaning and disinfection instructions in the operating manual.
4. If a different cleaning and disinfecting method is to be used, contact Eppendorf AG to ensure that the intended method will not damage the device.



NOTICE! Damage to electronic components due to condensation.

Condensate can form in the device after it has been moved from a cool environment to a warmer environment.

- ▶ After installing the device, wait for at least 4 h. Only then connect the device to the mains power supply.

3.5.2 Incorrect handling of the centrifuge



NOTICE! Damage from knocking against or moving the device during operation.

If the rotor bangs against the rotor chamber wall, it will cause considerable damage to the device and rotor.

- ▶ Do not move or knock against the device during operation.

3.5.3 Incorrect handling of the rotors



WARNING! Risk of injury from improperly attached rotors and rotor lids.

- ▶ Only centrifuge with rotor and rotor lid firmly tightened.
 - ▶ If unusual noises occur when the centrifuge starts, the rotor or the rotor lid may not be properly secured. Immediately press the **start/stop** key to stop centrifuging.
-



CAUTION! Risk of injury due to asymmetric loading of a rotor.

- ▶ Load rotors symmetrically with identical tubes or plates and buckets.
- ▶ Only load adapters with suitable tubes or plates.
- ▶ Always use tubes or plates of the same type (weight, material/density and volume).
- ▶ Check that loading is symmetrical by balancing the adapters and tubes or plates used with scales.

The device automatically detects imbalances during operation and stops the run immediately with an error message and a signal tone. Check the loading, balance the tubes and re-start the centrifugation.



CAUTION! Risk of injury from overloaded rotor.

The Centrifuge 5430/5430 R is designed for the centrifugation of material with a max. density of 1.2 g/mL at maximum speed and filling volume and/or load.

- ▶ Do not exceed the maximum load of the rotor.
-



NOTICE! Damage to rotors from aggressive chemicals.

Rotors are high-quality components which withstand extreme stresses. This stability can be impaired by aggressive chemicals.

- ▶ Avoid using aggressive chemicals, including strong and weak alkalis, strong acids, solutions with mercury, copper and other heavy metal ions, halogenated hydrocarbons, concentrated saline solutions and phenol.
 - ▶ If the rotor is contaminated by aggressive chemicals, clean it immediately using a neutral cleaning agent. This applies to the rotor bores, in particular.
 - ▶ Due to the manufacturing process, color variations may occur on rotors marked "coated". These color variations do not effect service life or resistance to chemicals.
-



NOTICE! If handled incorrectly, the rotor can fall over.

The rotor can fall over if the buckets are used as a handle.

- ▶ Remove the buckets before inserting and/or removing a swing-bucket rotor.
 - ▶ Always use both hands to carry the rotor cross.
-



CAUTION! Risk of injury due to chemically damaged rotor lids or caps.

Transparent rotor lids or caps made from PC, PP or PEI may lose their strength under the impact of organic solvents (e.g., phenol, chloroform).

- ▶ If rotor lids or caps have come into contact with organic solvents, they should be cleaned immediately.
 - ▶ Regularly check the rotor lids and caps for damages and cracks.
 - ▶ Immediately replace rotor lids or caps that have cracks or milky stains.
-

3.5.4 Extreme strain on the centrifuging tubes



CAUTION! Risk of injury from overloaded tubes.

- ▶ Note the loading limits specified by the tube manufacturer.
 - ▶ Only use tubes which are approved by the manufacturer for the required rcf.
-



NOTICE! Risk from damaged tubes.

Damaged tubes must not be used, as this could cause further damage to the device and the accessories and loss of the samples.

- ▶ Before use, visually check all of the tubes for damage.



NOTICE! Risk from open tube lids.

Open tube lids can brake off during centrifugation and damage the rotor and the centrifuge.

- ▶ Carefully seal all tube lids before centrifuging.

Exception: Note the information on the centrifugation of spin columns in the rotor FA-45-24-11-Kit (see p. 34).



NOTICE! Hazard to plastic tubes from organic solvents.

The density of plastic tubes is reduced when organic solvents (e.g., phenol, chloroform) are used, i.e. the tubes could become damaged.

- ▶ Observe the manufacturer's specifications for chemical resistance of the tubes.



NOTICE! Sample tubes heat up.

In uncooled centrifuges, the temperature in the rotor chamber, rotor and sample can increase to above 40 °C, based on the run time, g-force (rcf)/speed and ambient temperature.

- ▶ Note that this can reduce the centrifugation resistance of the sample tubes.
 - ▶ Please note the temperature resistance of the samples.
-

3.5.5 Aerosol-tight centrifugation



WARNING! Risk to health due to limited aerosol tightness with incorrect rotor/rotor lid combination.

Aerosol-tight centrifugation is guaranteed only if the rotors and rotor lids intended for this purpose are used. The designation of aerosol-tight fixed-angle rotors always starts with **FA**. The aerosol-tight rotors and rotor lids of this centrifuge are additionally marked with a red ring on the rotor and a red rotor lid screw.

Aerosol-tight swing-bucket rotors are marked with **AT** (aerosol-tight).

- ▶ For aerosol-tight centrifugation, always simultaneously use rotors and rotor lids which are marked as aerosol-tight in the centrifuge intended for the corresponding purpose. The details specifying in which centrifuge you may use the aerosol-tight rotors and rotor lids can be found on the rotor and, beginning from production date of October 2003, on the upper side of the rotor lid.
- ▶ Only use aerosol-tight rotor lids in combination with rotors which are marked on the rotor lid.
- ▶ Only use aerosol-tight buckets with the corresponding caps.



WARNING! Damage to health as a result of limited aerosol tightness and incorrect usage.

Autoclaving, mechanical stresses and contamination by chemicals or other aggressive solvents can impair the aerosol-tightness of the rotors and rotor lids.

- ▶ Check the integrity of the seals of the aerosol-tight rotor lids or caps before each use.
- ▶ Only use aerosol-tight rotor lids or caps if the seals are undamaged and clean.
- ▶ Lightly grease the threads of the rotor lid screw with pivot grease after every proper autoclaving (121 °C, 20 min.) (int. order no. Int. 5810 350.050, North America 022634330).
- ▶ Replace aerosol-tight rotor lids and caps after 50 autoclaving cycles.
- ▶ For QuickLock rotor lids, the seal must be replaced after 50 autoclaving cycles.
- ▶ **Never** store aerosol-tight rotors or buckets closed.

3.6 Safety notes on the device

Symbol	Meaning	Location
	Hazard point.	5430: Rear of the device 5430 R: Right side of the device
	CAUTION Always tighten the rotor with the enclosed rotor key.	Upper side of device, under the centrifuge lid.
	CAUTION Close all tubes and use a rotor lid.	Upper side of device, under the centrifuge lid.

4 Installation

4.1 Selecting the location



NOTICE! If an error occurs, the objects in the immediate proximity of the device will be damaged.

- ▶ In accordance with recommendations in EN 61010-2-020, leave a safety clearance of **30 cm** around the device during operation.
- ▶ Please remove all materials and objects from this area.



NOTICE! Damage from overheating.

- ▶ Do not install the device near heat sources (e.g. heating, drying cabinet).
- ▶ Do not expose the device to direct sunlight.
- ▶ Ensure unobstructed air circulation. Maintain a clearance of at least 30 cm around all ventilation grilles.

Select the location for the device according to the following criteria:

- Suitable power connection as per the name plate (230 V/120 V/100 V).
- Stable, horizontal and resonance-free lab bench.
- A well ventilated environment which is protected from direct sunlight to prevent the device from heating up more.

4.2 Preparing installation

Prerequisites

The weight of the centrifuge is 29 kg (5430) or 56 kg (5430 R). A second person is needed to unpack and position the device.



Retain the packaging material and the transport protection device for subsequent transport or storage. See also the instructions relating to transport (see p. 58).

- ▶ Perform the following steps in the sequence described.

Centrifuge 5430	Centrifuge 5430 R
<ol style="list-style-type: none"> 1. Open the packaging board. 2. Remove the covering cardboard. 3. Remove the accessories. 4. Grip from the strap retainers and have two persons lift the centrifuge out of the box. 5. Pull off the strap retainers, do not cut. 6. Remove the front and rear transport securing devices from the centrifuge. 7. Remove the plastic sleeve. 8. Carefully lift the centrifuge on one side and pull off the transport securing device of the motor on the underside of the centrifuge. 	<ol style="list-style-type: none"> 1. Open the packaging board. 2. Remove the accessories. 3. Lift and remove the front and rear transport securing devices. 4. Grip from the fabric straps and have two people lift the centrifuge out of the box. 5. Pull off the textile straps, do not cut. 6. Remove the plastic sleeve.

Installation

Centrifuge 5430/5430 R
English (EN)

4.3 Installing the instrument

Prerequisites

The device is on a suitable lab bench.

**NOTICE! Damage to electronic components due to condensation.**

Condensate can form in the device after it has been moved from a cool environment to a warmer environment.

- ▶ After installing the device, wait for at least 4 h. Only then connect the device to the mains power supply.

**NOTICE! Centrifuge 5430 R: compressor damage after improper transport.**

- ▶ Only switch on the centrifuge 4 h after installation.

Perform the following steps in the sequence described.

1. Let the device warm up to ambient temperature for at least 4 hours to avoid damaging electronic assemblies as a result of condensation and avoid damaging the compressor (only 5430 R).
2. Check that the mains voltage and frequency match the requirements on the device type plate.
3. Connect the centrifuge to the mains and switch it on using the mains/power switch on the rear of the device (Centrifuge 5430) or at the right side of the device (Centrifuge 5430 R).
 - The standby key $\text{\textcircled{C}}$ lights green.
 - The display is active.
 - **Only 5430:** Lid opens automatically
4. **Only 5430:** Remove the transport securing device of the motor shaft.



5. If the scope of delivery includes a rotor, dismantle and remove it using the supplied rotor key.
6. **Only 5430:** Remove the transport securing device of the air guide ring.



7. Use the details included in the scope of delivery to check that the delivery is complete.
8. Check all parts for any transport damage. Contact your dealer if any damage is found.



Retain the packaging material and the transport protection device for subsequent transport or storage. See also the instructions relating to transport (see p. 58).

5 Operation

5.1 Overview of operating controls

The Centrifuge 5430/5430 R is available in two versions: **keypad** or **rotary knobs**. This operating manual generally describes how to operate the keypad version. However, it also applies to the rotary knob version.

Before using the Centrifuge 5430/5430 R for the first time, familiarize yourself with the operating controls and the display.

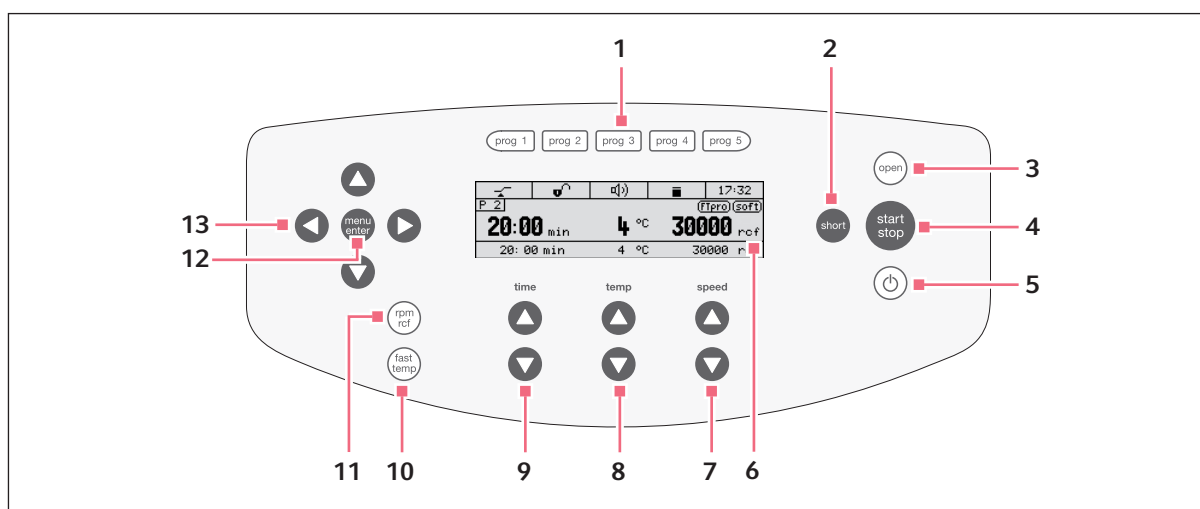

Fig. 5-1: Control panel and display of Centrifuge 5430/5430 R (keypad version).

- | | |
|---|---|
| <p>1 Select program
Press briefly: load the stored centrifuging parameters.
Press and hold (> 2 sec): save the current centrifuging parameters (see p. 47).</p> | <p>8 Adjust the temperature (only 5430 R)</p> |
| <p>2 Short Spin centrifugation
(see p. 40)</p> | <p>9 Adjust the centrifuging duration
Dependent on device version, designed as key or rotary knob.</p> |
| <p>3 Release lid</p> | <p>10 Start the temperature control cycle Fast Temp (only 5430 R)
(see p. 36)</p> |
| <p>4 Start and stop centrifugation</p> | <p>11 Switch the displayed centrifuging speed (rpm/rcf)</p> |
| <p>5 Activate/deactivate standby mode
Key lights green: centrifuge is ready for operation.
Key lights red: standby mode active (see p. 41).</p> | <p>12 Call and select the menu parameters
(see p. 47)</p> |
| <p>6 Display</p> | <p>13 Navigating the menu
(see p. 29)</p> |
| <p>7 Set speed of centrifugation
Dependent on device version, designed as key or rotary knob.</p> | |

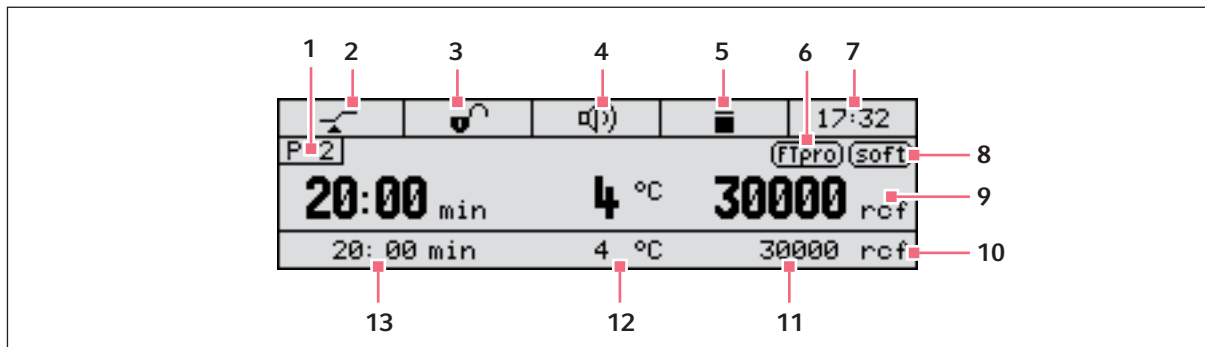













Fig. 5-2: Display of the Centrifuge 5430/5430 R

- | | |
|--|---|
| <p>1 Program number (if enabled)</p> <p>2 Status of the function At set rpm
 : Start of operation when reaching 95% of the preset g-force (rcf) or speed.
 : Start of run time immediately.</p> <p>3 Status of the key lock
 : Centrifuging parameters cannot be modified unintentionally.
 : No key lock.</p> <p>4 Status of the loudspeaker
 : Switched on.
 : Switched off.</p> <p>5 Status of the centrifuge
 : Centrifuge lid unlocked.
 : Centrifuge lid locked.
  (flashing): Centrifuging in progress.</p> <p>6 Temperature control cycle programming (only 5430 R)
 : Fast Temp pro is enabled, i.e., start time and temperature of the temperature control run have been programmed (see p. 37).</p> <p>7 Time</p> | <p>8 Soft ramp
 : Rotor accelerates and brakes slowly.
 No symbol: Rotor accelerates and brakes rapidly.</p> <p>9 Standard display</p> <p>10 Extended display (if enabled)</p> <p>11 g-force/speed</p> <p>12 Temperature (only 5430 R)</p> <p>13 Centrifuging duration</p> |
|--|---|

Please also read the precise description of the individual functions (see p. 47).





5.2 Menu navigation

The menu consists of two levels. To change settings, generally proceed as follows.

1.		Open menu.
----	---	------------

Operation









Centrifuge 5430/5430 R
English (EN)

2.		Select the desired menu item.
3.		Confirm selection.
4.		Select the setting of the parameters in question.
5.		Confirm changed setting. A tick appears in front of the confirmed setting.
6.		Keep pressing the key until you reach the desired menu level or exit the menu. Some menus can only be exited by selecting and confirming the menu item <i>Back / Zurück / Retour / Atrás</i> .

5.3 Configure centrifuge

5.3.1 Set menu language











Proceed as follows to set menu language.

1.		Open the menu.
2.		Select <i>Settings</i> .
3.		Confirm your selection.
4.		Select <i>Language</i> .
5.		Confirm your selection.
6.		Select <i>English, Deutsch, Francais</i> or <i>Espanol</i> .
7.		Confirm your selection. A tick appears in front of the selected language. The setting takes effect immediately.
8.		Press key several times to exit the menu.

5.3.2 Setting the date and time

Proceed as follows to set date and time.

1.		Open the menu.
----	---	----------------

2.		Select <i>Settings</i> .
3.		Confirm your selection.
4.		Select <i>Date/time</i> .
5.		Confirm your selection.
6.		Set date.
7.		Confirm setting.
8.		Set time format (12 h/24 h).
9.		Confirm setting.
10.		Set time.
11.		Confirm setting.
12.		Press key several times to exit the menu.



There is no automatic switch between summer time and winter time.

5.4 Preparing for centrifugation

5.4.1 Switching on the centrifuge

1. Switch on the centrifuge using the mains power switch or the  standby key.
Only 5430: After switching on at the mains power switch, the centrifuge lid opens automatically.
2. Open the closed centrifuge lid by pressing the **open** key.
The parameter settings of the last run are displayed.

5.4.2 Inserting the rotor



- ▶ **Swing-bucket rotors:** remove the buckets before inserting and/or removing the rotor. Use both hands to pick up the rotor cross.
- ▶ **Rotor F-35-6-30:** only use the rotor removal tool supplied to insert or remove the rotor.

1. Fit the rotor vertically on the motor shaft.
2. Insert the supplied rotor key into the rotor nut.
Rotor FA-45-24-11-HS: Use the special rotor key.
3. Turn rotor key **clockwise** until the rotor nut is firmly tightened.

5.4.3 Automatic rotor detection

The centrifuge has automatic rotor detection. It detects a newly inserted rotor during centrifugation and displays its name for approx. 2 seconds. The set g-force (rcf)/speed (rpm) is automatically limited to the maximum permissible value of the rotor, if necessary.



If you start centrifuging immediately after a rotor change, the centrifuge has not carried out an automatic rotor detection yet. The speed set for the previous rotor may exceed the maximum permitted speed for the new rotor. In this case the centrifuge stops after the automatic rotor detection and displays the error message *Note C*. The new maximum permitted speed appears in the display. You can then restart the centrifuging with this setting or adjust the speed as necessary.

- ▶ Always check the set g-force (rcf)/speed (rpm) after a rotor change and adjust it if necessary.

5.4.4 Manual rotor detection



CAUTION! Risk of injury when turning the rotor manually.

- ▶ When turning a swing-bucket rotor, pay special attention to ensure that your fingers do not get jammed or get caught on the swinging buckets.

- ▶ In order to trigger the rotor detection manually, turn the rotor **counterclockwise** by hand.
 - The name of the rotor appears in the display.
 - The g-force (rcf)/speed (rpm) automatically is limited to the maximum value of the rotor.

5.4.5 Loading the rotor



CAUTION! Risk of injury due to asymmetric loading of a rotor.

- ▶ Load rotors symmetrically with identical tubes or plates and buckets.
- ▶ Only load adapters with suitable tubes or plates.
- ▶ Always use tubes or plates of the same type (weight, material/density and volume).
- ▶ Check that loading is symmetrical by balancing the adapters and tubes or plates used with scales.

The device automatically detects imbalances during operation and stops the run immediately with an error message and a signal tone. Check the loading, balance the tubes and re-start the centrifugation.



CAUTION! Risk from damaged or overloaded tubes.

- ▶ When loading the rotor, observe the safety precautions on dangers as a result of overloaded or damaged tubes (see *Warnings for intended use on p. 20*).



The device automatically detects imbalances during operation and stops the run immediately with an error message and a signal tone.

- ▶ Check the load, balance the tubes and restart the run.

5.4.5.1 Fixed-angle rotors



Rotor lid

- Fixed-angle rotors may only be operated with the appropriate rotor lid in each case. This is clearly shown by the identical rotor name labeling on the rotor and on the rotor lid.
- To carry out an aerosol-tight centrifugation, an aerosol-tight rotor (label: **red ring**) and the corresponding aerosol-tight rotor lid (label: **aerosol-tight** and **red lid screw**) must be used.

To load the rotor, proceed as follows:

1. Check the maximum load (adapter, tube and contents) per rotor bore.
The information about this can be found on the rotor and in this operating manual (see *Rotors on p. 12*).
2. Load rotors and adapters only with the tubes intended for them.
3. Insert tubes opposite each other in pairs into the rotor bores. To ensure symmetric loading, tubes that are arranged opposite each other must be of the same type and contain the same filling quantity.

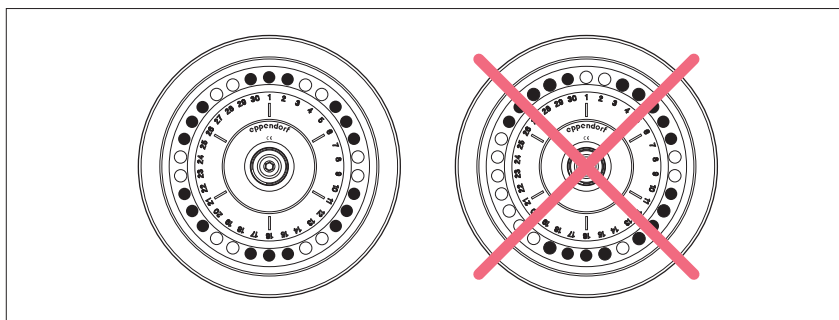

To minimize weight differences between filled sample tubes, we recommend taring with a scale. This will reduce wear on the drive and reduce running noise.

4. Attach and tighten rotor lid.



Spin columns

For centrifuging spin columns in the rotor FA-45-24-11-Kit, you can leave the tube lids open. However, this can only be done using the tubes provided by kit manufacturers for this purpose. For reliable centrifugation, you must lean the open tube lids against the edge of the rotor. Ensure that this does not involve the lids projecting beyond the edge of the rotor, and then put on the associated rotor lid.

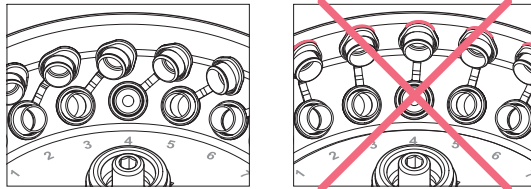

5.4.5.2 Swing-bucket rotor

Prerequisites

- A combination of rotor, carrier and adapter, approved by Eppendorf.
- Matching and tested tubes and plates.



NOTICE! Filling the plates too high can cause overflowing.

During the run the meniscuses in the tubes along the edges of the plates are at an angle. This is due to the centrifugal forces and cannot be avoided.

- ▶ Fill the wells of the plates to a maximum of $\frac{2}{3}$ of the max. capacity.

To load the rotor, proceed as follows:

1. Check the carrier grooves for cleanliness and grease lightly with pivot grease (order no. Int.: 5810 350.050 / North America: 022634330).
Dirty grooves and pivots prevent carriers from swinging out evenly.
2. Hang the buckets into the rotor.
All rotor positions must be loaded with carriers.
3. Check that all carriers are hanging properly and can swing freely.
4. Carry out a manual loading and swing test the first time a tube or plate type is used.
5. Check the maximum load per carrier (adapter, tube or plate and contents) and the loading height.
The information about this can be found on the rotor and in this operating manual (see *Rotors* on p. 12).

6. Load the buckets symmetrically.

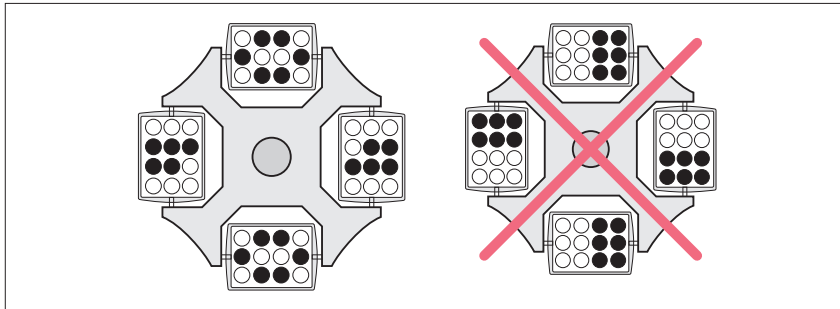

Fig. 5-3: Incomplete, but symmetric loading of the buckets. The pegs of each bucket must be uniformly loaded.

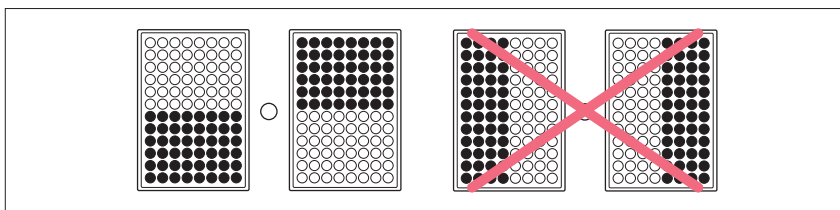



Fig. 5-4: Symmetrical loading of the plates.

The plate arrangement shown on the right-hand side is incorrect, as the buckets will not swing properly. The plates have some play in the buckets.

7. Check the loading of the bucket.

-  ▶ Carry out a brief centrifugation test at low speed (e.g., 1000 rpm) when you use a tube or plate type for the first time.
-  **Only 5430 R:** When using the A-2-MTPs, centrifuge without the upper shell of the wind shield in order to guarantee precise and quick temperature control of samples. Note that the centrifugation noise will increase slightly in this case. This does not apply to the S-24-11-AT. The S-24-11-AT must always be operated with a rotor lid.

5.4.6 Closing the centrifuge lid



WARNING! Risk of injury when opening or closing the centrifuge lid.

There is a risk of crushing your fingers when opening or closing the centrifuge lid.

- ▶ When opening or closing the centrifuge lid, do not reach between the lid and device or into the latching mechanism of the lid.
- ▶ Always open the centrifuge lid completely to prevent it from falling.

1. Check the correct attachment of the rotor and rotor lid.
2. Push down the centrifuge lid until the lid latch engages and the lid is automatically closed.

The centrifuge will close automatically.

The **open** key lights up blue. The  symbol appears in the display.

Operation

Centrifuge 5430/5430 R
English (EN)

5.5 Cooling (only 5430 R)

5.5.1 Temperature adjustment

- ▶ Set the temperature using the **temp** arrow keys between -11°C and +40°C.

You can also modify the temperature during centrifugation.

At higher ambient temperature a brief fan noise is possible until the desired temperature has been reached. This indicates a heavy cooling performance.

5.5.2 Temperature display

If the rotor is stopped: Target temperature

During centrifugation: Actual temperature

The set temperature appears in the extended display.

5.5.3 Temperature monitoring

After the target temperature has been reached, the centrifuge reacts to temperature deviations during centrifugation as follows:

Deviation from set value	Action
± 3 °C	Temperatures on the display are flashing.
± 5 °C	Periodic warning tone and display <i>Error 18</i> . Centrifugation is stopped automatically.

5.5.4 FastTemp

This function can be used to start a temperature control run directly without samples with a rotor and temperature-specific speed in order to quickly adjust the rotor chamber, including the rotor, buckets and adapters, to the previously set nominal temperature.

The **FastTemp pro** function for programming the temperature control run with defined start times is described in the next section.

Prerequisites

- The centrifuge is switched on.
- The rotor and rotor lid are properly attached.
- The centrifuge lid is closed.
- Temperature and g-force (rcf)/speed (rpm) for the centrifugation are set (see *Centrifuging on p. 39*).



1. Press the **fast temp** key.

The display shows *Fast Temp*, the remaining duration of the temperature control run as well as the current temperature and g-force (rcf)/speed (rpm).

The temperature control run automatically ends when the set temperature is reached. A periodic signal tone sounds.

2. Press the **start/stop** key to terminate the temperature control run early.

After the set temperature has been reached and the temperature control run is complete, the centrifuge keeps the rotor chamber with the centrifuge lid closed at the set target temperature if the temperature is below the ambient temperature. However, independent of the target temperature, 4 °C must be met via this continuous cooling in order to prevent the rotor chamber from freezing.



-  The centrifuge stops the cycle automatically if the rotor or the buckets have reached the set temperature. Therefore, there may be a delay of approx. 30 min between the display of the set temperature and the automatic end of the temperature control run.
-  **Only 5430 R:** When using the A-2-MTPs, centrifuge without the upper shell of the wind shield in order to guarantee precise and quick temperature control of samples. Note that the centrifugation noise will increase slightly in this case.
This does not apply to the S-24-11-AT. The S-24-11-AT must always be operated with a rotor lid.

5.5.5 FastTemp pro

You can have the previously described temperature control run **FastTemp** (see p. 36) start automatically at a specified time. Two options are available:

Once	The temperature control cycle is started once at the set time.
Repeatedly	The temperature control cycle is started at the set time on the next specified weekday. This is repeated for an unlimited period of time with each weekday specified.

5.5.5.1 Programming the start time

1. Select *Fast Temp pro* in the device menu.
2. Select *Once* or *Repeatedly*.
This selection only appears as long as the **FastTemp pro** function has not already been activated. Otherwise it is only possible to edit or delete the programmed start time.
3. Only with *Repeatedly*: Activate/deactivate weekdays with **menu/enter**, select *Continue* and confirm with **menu/enter**.
4. Enter date and time for the one-time or repeated start of the temperature control run as well as the set temperature and confirm with **menu/enter**.
An overview of the current settings is displayed.
5. Edit the settings again or save.
6. Exit the menu.
 - **FastTemp pro** is now activated. In the display the  symbol appears as long as an automatic start of a temperature control run is still outstanding. In the standby mode  *Fast Temp pro* is displayed.
 - The temperature control run **FastTemp** (see p. 36) starts automatically at the set time.
 - After a one-off programmed temperature control run, the following symbol is extinguished . With several programmed temperature control runs, the **FastTemp pro** remains active until you deactivate it. To do this, select *Fast Temp pro* in the device menu and delete the settings.

5.5.5.2 Preparing the centrifuge

- ▶ Ensure that the centrifuge is switched on or in the standby mode during the start time set and the rotor and rotor lid are properly attached and the centrifuge lid is closed.

5.5.5.3 Automatic start of the temperature control cycle

1. If the centrifuge is in standby mode, it switches to the operating mode 1 min before the set start time.
2. At the start time the temperature control run **FastTemp** (see *FastTemp* on p. 36) begins. *Fast Temp pro* appears in the display.

Automatically starting the temperature control cycle is not possible during centrifugation.

5.5.6 Continuous cooling

If the rotor stops, the rotor chamber will be maintained at the target temperature if the following requirements have been met:

- The centrifuge is switched on.
- The centrifuge lid is closed.
- The target temperature is lower than the ambient temperature.
- The centrifuge is not in standby mode.

During continuous cooling the following applies:

- The set and actual temperature are displayed alternately.
- Irrespective of the set temperature, the temperature does not go below 4 °C to prevent the rotor chamber from freezing and from increased condensation in the device.
- The temperature adjustment is slower because the rotor does not rotate during this process.

To end continuous cooling, open the centrifuge lid or press the standby key.

If the centrifuge is not used for more than 8 hours, the continuous cooling is switched off automatically. The device then switches to standby mode. This protects against ice formation in the rotor chamber and increased condensation in the device. With **FastTemp** you can quickly reach the desired temperature again (see p. 36).

You can change the continuous cooling to endless operation at your own risk. To do so, in the device menu under *Continuous cooling* enable the ∞ (see p. 48) item.

5.6 Centrifuging



CAUTION! Risk from incorrectly-loaded rotors and damaged/overloaded tubes!

- ▶ Before commencing centrifugation, follow the safety instructions relating to risks from asymmetrically loaded and/or overloaded rotors and from overloaded, damaged and/or open tubes (see *Warnings for intended use on p. 20*).



WARNING! Risk of injury from improperly attached rotors and rotor lids.

- ▶ Only centrifuge with rotor and rotor lid firmly tightened.
- ▶ If unusual noises occur when the centrifuge starts, the rotor or the rotor lid may not be properly secured. Immediately press the **start/stop** key to stop centrifuging.

Each of the centrifuging variants described here must be preceded by the preparation described above (see *Preparing for centrifugation on p. 32*).



Only 5430 R: Please also note the instructions on cooling (see *Cooling (only 5430 R) on p. 36*).

5.6.1 Centrifugation with time setting

Perform the following steps in the sequence described.

1. Use the **time** arrow keys to set run time.
2. **Only 5430 R:** Use the **temp** arrow keys to adjust the temperature.
3. Use the **speed** arrow keys to the g-force (rcf)/speed.
4. Press **start/stop** to start centrifuging.

During centrifugation:

-  blinks in the display as long as the rotor is running.
- The remaining run time will be displayed in minutes. The last minute is counted down in seconds.
- **Only 5430 R:** The current temperature will be displayed.
- The current g-force (rcf) or rotor speed is displayed.
- The shortcut keys, the , **open** and **short** keys, and all menu items which directly affect centrifugation, are blocked during centrifugation.

End of centrifugation

- The centrifuge automatically stops after the set time has elapsed. The elapsed centrifugation will be shown in a blinking display during the braking process. A signal tone sounds when the rotor is at a standstill.
- **Only 5430:** The centrifuge lid opens automatically. The display shows the symbol .
- **Only 5430 R:** The centrifuge lid remains closed to maintain the sample temperature. It can be opened lid by pressing the blinking **open** key.

5. Remove the material for centrifuging.





- During the run you can modify the total run time, the temperature (only 5430 R), the speed and the rpm/rcf indication. The new parameters are adopted immediately. Please note that the shortest new total run time that can be set is the elapsed time plus 2 minutes.
- You can also terminate the centrifugation before the set run time has elapsed by pressing the **start/stop** key.

Operation

Centrifuge 5430/5430 R
English (EN)



5.6.2 Centrifuging in continuous operation

Perform the following steps in the sequence described.

1. Use the **time** arrow keys to set the continuous run.
The continuous operation function can be set above 99:59 h or below 30 seconds. The timer shows  to indicate continuous operation.
2. **Only 5430 R:** Use the **temp** arrow keys to adjust the temperature.
3. Use the **speed** arrow keys to the g-force (rcf)/speed.
4. Press **start/stop** to start centrifuging.
 blinks in the display as long as the rotor is running.
Time is counted upwards, first in 30-second increments and then in minute increments from ten minutes.
5. Press **start/stop** to end centrifuging after the desired time period.
 - The centrifugation time will be shown in a blinking display during the braking process.
 - A signal tone sounds when the rotor is at a standstill.
 - **Only 5430:** The centrifuge lid opens automatically. The display shows the symbol .
 - **Only 5430 R:** The centrifuge lid remains closed to maintain the sample temperature. It can be opened lid by pressing the blinking **open** key.
6. Remove the material for centrifuging.

5.6.3 Short-spin centrifugation

You can carry out a short-spin cycle with the currently set or with the maximum g-force (rcf)/speed of the rotor used. This is set in the device menu (see *Other menu items on p. 48*) before executing the following steps in the sequence specified:

1. For short-spin cycle with the current g-force (rcf)/speed, set this directly with the arrow keys **speed**.
2. **Only 5430 R:** Use the **temp** arrow keys to adjust the temperature.
3. Start the short run: Hold the **short** key pressed down.
 -  blinks in the display as long as the rotor is running.
 - The time is counted upwards in seconds.
 - During short run centrifuging all other keys are blocked. However, short run centrifuging is interrupted if another key is pressed simultaneously.
4. End short spin run: Release the **short** key.
 - The centrifugation time will be shown in a blinking display during the braking process.
 - A signal tone sounds when the rotor is at a standstill.
 - **Only 5430:** The centrifuge lid opens automatically. The display shows the symbol .
 - **Only 5430 R:** The centrifuge lid remains closed to maintain the sample temperature. It can be opened lid by pressing the blinking **open** key.
5. Remove the material for centrifuging.



During the braking process, you can restart the centrifugation up to two times by pressing the **short** key again.



The soft ramp does not work during short-spin centrifugation.

5.6.4 Removing the rotor



- ▶ **Swing-bucket rotors:** remove the buckets before inserting and/or removing the rotor. Use both hands to pick up the rotor cross.
- ▶ **Rotor F-35-6-30:** only use the rotor removal tool supplied to insert or remove the rotor.

1. Turn the rotor nut **counterclockwise** using the supplied rotor key.
Rotor FA-45-24-11-HS: use special rotor key.
2. Remove the rotor vertically in an upward motion.
3. **Only 5430 R:** Switch off the centrifuge after use and empty the condensation water tray (remove it from the left side of the device). Leave centrifuge lid fully opened and protect it against closing.

5.7 Standby mode

The centrifuge automatically changes from the ready state to the standby mode if the following prerequisites are met:

- The centrifuge was not used for the time set in the device menu (1 to 60 min)(see *Settings on p. 49*)
- **Only 5430 R:** The centrifuge lid is open.

In the **Standby mode**, the following applies :

- The standby key  lights red.
- **Only 5430 R:** The rotor chamber is not cooled (see *Continuous cooling on p. 38*).

In the **Ready state**, the following applies:

- The centrifugation parameters are displayed.
- The standby key  lights green.
- **Only 5430 R:** The rotor chamber is cooled when the centrifuge lid is closed (see *Continuous cooling on p. 38*).

You can switch between standby mode and ready state at any time when centrifugation is not performed by pressing the standby key.

5.8 User instructions on rotors

5.8.1 Rotor F-35-6-30: rotor removal tool

5.8.1.1 Inserting the rotor

Prerequisites

The rotor nut is loose.

Use the rotor removal tool to insert the rotor in the centrifuge and remove it again.

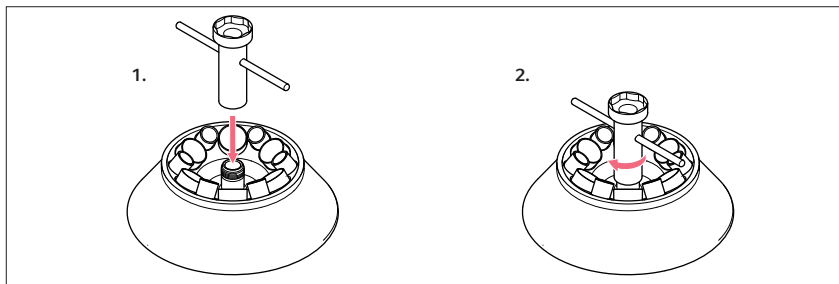

1. Position the rotor removal tool with the narrow side on the rotor thread.
2. Tighten the rotor removal tool clockwise with approx. 3 revolutions.
3. Grip the rotor removal tool and insert the rotor.
4. Loosen and remove the rotor removal tool by turning it counterclockwise.
5. **Inserting the rotor:** Tighten the rotor using the enclosed rotor key (see *Inserting the rotor on p. 32*).

5.8.1.2 Loosening the rotor lid

Use the rotor removal tool to loosen a firmly tightened rotor lid screw.

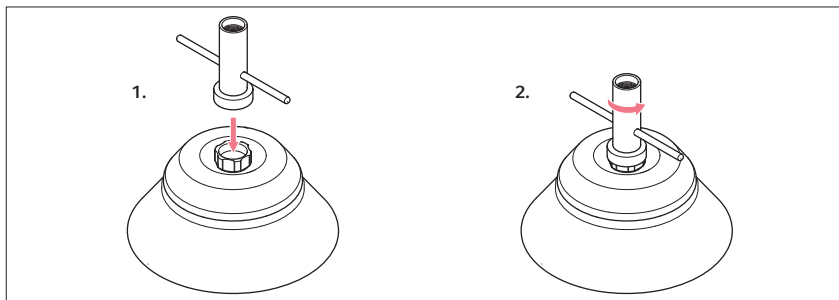

1. Position the rotor removal tool with the wide side on the rotor lid screw.
2. Loosen the rotor lid screw by turning the rotor removal tool counterclockwise.

5.8.2 Rotor A-2-MTP

5.8.2.1 Inserting the rotor



NOTICE! If handled incorrectly, the rotor can fall over.

The rotor can fall over if the buckets are used as a handle.

- ▶ Remove the buckets before inserting and/or removing a swing-bucket rotor.
- ▶ Always use both hands to carry the rotor cross.

5.8.2.2 Position and remove the upper shell of the wind shield

The upper shell of the wind shield is used for noise reduction.

1. Before it is used for the first time, remove the attachment that is mounted on the knob of the upper shell of the wind shield .
2. Position the upper shell of the wind shield and rotate a max. 1/4 revolution until it is lowered onto the rotor hub.

The lock indicator must protrude so far over the knob that the red marking is clearly visible:

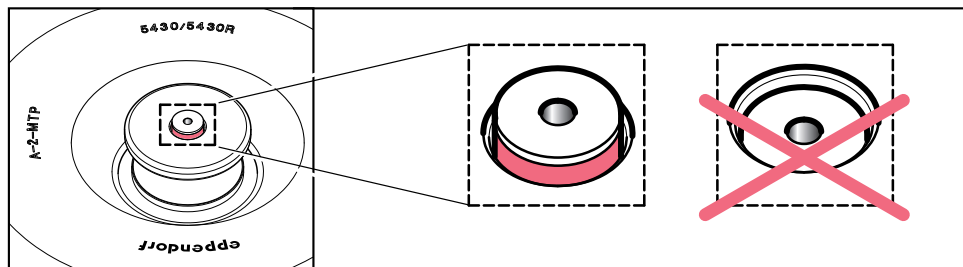

The loose positioning of the upper shell is intentional and aids in self-centering.

3. Pull on the knob of the upper shell of the wind shield in order to lift it.



Only 5430 R: When using the A-2-MTPs, centrifuge without the upper shell of the wind shield in order to guarantee precise and quick temperature control of samples. Note that the centrifugation noise will increase slightly in this case.

This does not apply to the S-24-11-AT. The S-24-11-AT must always be operated with a rotor lid.

5.8.3 Rotor FA-45-24-11-HS: using the special rotor key

5.8.3.1 Tightening the rotor

1. Insert the rotor key for rotor FA-45-24-11-HS in the rotor nut.
2. Turn the rotor key clockwise until it spins through ("click").

The rotor is correctly tightened.

5.8.3.2 Loosening the rotor

- ▶ Turn the rotor nut and rotor key for Rotor FA-45-24-11-HS counterclockwise.



The rotor key for Rotor FA-45-24-11-HS can only be used to tighten and loosen this rotor. For the other rotors described in this operating manual, use the rotor key that is delivered with the Centrifuge 5430/5430 R.

Operation

Centrifuge 5430/5430 R
English (EN)

5.8.4 QuickLock

Aerosol-tight rotors FA-45-48-11, FA-45-30-11, FA-45-24-11-Kit, FA-45-16-17 and S-24-11-AT have a quick lock for the rotor lid (QuickLock).

Rotors FA-45-30-11 and FA-45-24-11-Kit have been redesigned and are now only available with a quick lock (QuickLock) instead of a rotor lid thread.

Closing the rotor lid

1. Check the correct positioning of the external sealing ring in the groove.
2. Place the rotor lid on the rotor in a vertical motion.
3. To lock the rotor, turn the red rotor lid screw clockwise as far as it will go, and after an audible "click" is heard.



The rotor is correctly locked after the audible "click" is heard!

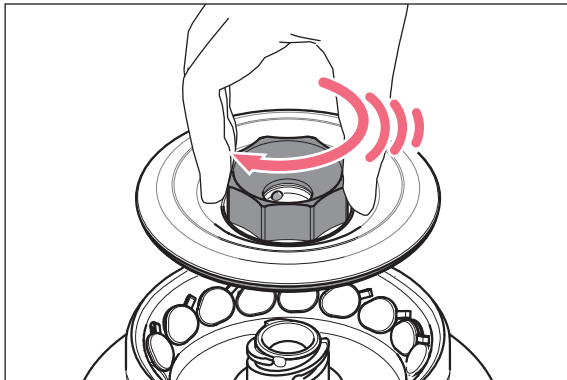







If the locking system is stiff, lightly lubricate the pins in the rotor lid screw with pivot grease.

6 Operating controls and function

6.1 Device menu

Most menu levels contain the additional menu item *Back / Zurück / Retour / Atrás*. Detailed information on the menu can be found in the following chapters.

Tab. 6-1: Menu structure of the Centrifuge 5430/5430 R in four different menu languages.

English	Deutsch	Français	Español	Display
Programs <ul style="list-style-type: none"> • Load program • Save program • Delete program 	Programme <ul style="list-style-type: none"> • Programm laden • Programm speichern • Programm löschen 	Programmes <ul style="list-style-type: none"> • Charger prog. • Enregistrer prog. • Supprimer prog. 	Programas <ul style="list-style-type: none"> • Cargar programa • Guardar programa • Borrar programa 	
Soft ramp <ul style="list-style-type: none"> • On • Off 	Softrampe <ul style="list-style-type: none"> • An • Aus 	Rampe douce <ul style="list-style-type: none"> • Marche • Arrêt 	Rampa suave <ul style="list-style-type: none"> • Encendido • Apagado 	(SOFT)
Key lock <ul style="list-style-type: none"> • On • Off 	Tastensperre <ul style="list-style-type: none"> • An • Aus 	Verrouilla. de touches <ul style="list-style-type: none"> • Marche • Arrêt 	Bloqueo del teclado <ul style="list-style-type: none"> • Encendido • Apagado 	 
At set rpm <ul style="list-style-type: none"> • On • Off 	At set rpm <ul style="list-style-type: none"> • An • Aus 	At set rpm <ul style="list-style-type: none"> • Marche • Arrêt 	At set rpm <ul style="list-style-type: none"> • Encendido • Apagado 	 
Short spin <ul style="list-style-type: none"> • Maximum speed • Current speed 	Short Spin <ul style="list-style-type: none"> • Maximaler Wert • Aktueller Wert 	Short Spin <ul style="list-style-type: none"> • Vitesse max • Vitesse actuelle 	Short Spin <ul style="list-style-type: none"> • Velocidad máximo • Velocidad actual 	
Continuous cooling (5430 R) <ul style="list-style-type: none"> • 8 h • ∞ 	Dauerkühlung (5430 R) <ul style="list-style-type: none"> • 8 h • ∞ 	Refrigération continue (5430 R) <ul style="list-style-type: none"> • 8 h • ∞ 	Refrigeración continua (5430 R) <ul style="list-style-type: none"> • 8 h • ∞ 	
Fast Temp pro (5430 R) <ul style="list-style-type: none"> • One-time-use • Repeated use 	Fast Temp pro (5430 R) <ul style="list-style-type: none"> • Einmal • Mehrmals 	Fast Temp pro (5430 R) <ul style="list-style-type: none"> • Une fois • Plusieurs fois 	Fast Temp pro (5430 R) <ul style="list-style-type: none"> • Una vez • Varias veces 	(FTPro)
Settings <ul style="list-style-type: none"> • Display <ul style="list-style-type: none"> – Standard display – Extended display • Alarm <ul style="list-style-type: none"> – On – Off 	Einstellungen <ul style="list-style-type: none"> • Anzeige <ul style="list-style-type: none"> – Standardanzeige – Erweiterte Anzeige • Lautsprecher <ul style="list-style-type: none"> – An – Aus 	Réglages <ul style="list-style-type: none"> • Affichage <ul style="list-style-type: none"> – Affichage standard – Affichage large • Signal sonore <ul style="list-style-type: none"> – Marche – Arrêt 	Ajustes <ul style="list-style-type: none"> • Indicador <ul style="list-style-type: none"> – Indicador estándar – Indicador extendido • Altavoz <ul style="list-style-type: none"> – Encendido – Apagado 	 

Operating controls and function

Centrifuge 5430/5430 R
English (EN)

English	Deutsch	Français	Español	Display
<ul style="list-style-type: none"> • Volume <ul style="list-style-type: none"> – Cancel – Save – Default • Date/Time • Contrast <ul style="list-style-type: none"> – Cancel – Save – Default • Language <ul style="list-style-type: none"> – English – Deutsch – Français – Español • Standby <ul style="list-style-type: none"> – On – Off – Set time • Lid release (5430) <ul style="list-style-type: none"> – Automatic – Manual 	<ul style="list-style-type: none"> • Lautstärke <ul style="list-style-type: none"> – Abbrechen – Speichern – Lieferzustand • Datum/Uhrzeit • Kontrast <ul style="list-style-type: none"> – Abbrechen – Speichern – Lieferzustand • Sprache <ul style="list-style-type: none"> – English – Deutsch – Français – Español • Standby <ul style="list-style-type: none"> – An – Aus – Zeit einstellen • Deckelöffnung (5430) <ul style="list-style-type: none"> – Automatisch – Manuell 	<ul style="list-style-type: none"> • Volume <ul style="list-style-type: none"> – Annuler – Enregistrer – Réglage usine • Date/Heure • Contraste <ul style="list-style-type: none"> – Annuler – Enregistrer – Réglage usine • Langue <ul style="list-style-type: none"> – English – Deutsch – Français – Español • Mise en veille <ul style="list-style-type: none"> – Marche – Arrêt – Réglage du temps • Ouverture couvercle (5430) <ul style="list-style-type: none"> – Automatique – Manuelle 	<ul style="list-style-type: none"> • Volumen <ul style="list-style-type: none"> – Cancelar – Guardar – Est. de Fábrica • Fecha/Hora • Contraste <ul style="list-style-type: none"> – Cancelar – Guardar – Est. de Fábrica • Idioma <ul style="list-style-type: none"> – English – Deutsch – Français – Español • Standby <ul style="list-style-type: none"> – Encendido – Apagado – Establecer tiempo • Apertura de la tapa (5430) <ul style="list-style-type: none"> – Automática – Manual 	

5430: only for Centrifuge 5430

5430 R: only for Centrifuge 5430 R

6.2 Settings in the device menu

6.2.1 Programs

The Centrifuge 5430/5430 R has more than 50 programmable memory locations.

Load program	Load the selected program. This appears in the display with number and name and can be started immediately using the \triangleleft start/stop key. When selecting a program with a too high g-force (rcf)/speed for the rotor used, it flashes and a safety message appears.
Save program	Save the set centrifugation parameters (centrifugation duration, temperature (only 5430 R), g-force (rcf)/speed, soft ramp and At set rpm) under the selected number. In addition, you can assign a program name with a maximum of 20 characters. The centrifuging duration, the temperature (only 5430 R) and the g-force/rotational speed can still be changed in this menu using the corresponding arrow buttons time , temp (only 5430 R) and speed .
Delete program	Delete the selected program. Program numbers 1 to 5 cannot be deleted.

These functions are only available with the centrifuge at a standstill.

If the program memory is empty the menu item *Delete program* is exited automatically after the last program has been deleted. You will furthermore be unable to call up this menu item if the program memory is empty.

Program numbers which are already occupied can be overwritten.

6.2.2 Use program keys

You can also save and load Programs 1 to 5 directly by pressing the program keys:

6.2.2.1 Load program

- ▶ Press the desired program key **briefly**.

The pressed program key illuminates in blue, the parameters are displayed.

By pressing again, you can exit the selected program again. The blue light of the key will then go out. The parameters of the most recent centrifugation are then displayed again.







6.2.2.2 Save program

1. Set the centrifugation parameters (centrifugation duration, temperature (only 5430 R), g-force (rcf)/speed, soft ramp and At set rpm).
2. Press the desired program key for at least **2 seconds**.







A signal tone sounds and the program key you pressed lights up.

The centrifuging parameters are saved under the appropriate program number (1-5).

6.2.3 Other menu items

Menu item/meaning	Setting	Function	Display
Soft ramp Reduce speed of acceleration and braking ramp. Not used for Short Spin centrifuging.	on off	Rotor accelerates and brakes slowly. Rotor accelerates and brakes rapidly.	
Key lock Set the current centrifugation parameters permanently to prevent the time, temperature (only 5430 R), g-force (rcf) or speed, soft ramp and At set rpm from being unintentionally modified.	on off	Set the centrifugation parameters permanently. Release the permanent settings.	 
At set rpm Set start of centrifuging run time.	on off	The set time is counted down only once 95% of the specified g-force (rcf) or speed has been reached. The set time is counted down immediately.	 
Short Spin Before the start of a short run (see <i>Short-spin centrifugation on p. 40</i>) it is possible to switch between the maximum and currently set g-force (rcf) or speed. Soft ramp is not used for Short Spin centrifuging.	Maximum value Current value	Short-spin run at maximum g-force (rcf) or speed of the rotor used. Short run at set g-force (rcf)/speed.	
Continuous cooling (only 5430 R) Time limitation of continuous cooling (see p. 38) . Continuous cooling is only activated when the rotor is stopped and the centrifuge lid is closed.	8 h ∞	Preset value. Endless operation of continuous cooling. Caution! Icing possible! Set at own risk!	
Fast Temp pro (only 5430 R) Time and temperature programming for the automatic temperature control run. The selection <i>Once/Repeatedly</i> only appears if no Fast Temp pro has been set (see <i>FastTemp pro on p. 37</i>).	Once Repeatedly	Set the date and time for the start of a temperature control run. Set the week days and the common start time for several repeated temperature control runs. Fast Temp pro is active from the date set.	

6.2.4 Settings

Menu item/meaning	Setting	Function	Display
<p>Display Select standard display or extended display of centrifuging parameters.</p>	<p>Standard display</p> <p>Extended display</p>	<p>If the centrifuge is at rest the target values are displayed, and during centrifugation the actual values of run time, temperature (only 5430 R) and the g-force (rcf)/speed.</p> <p>In addition to the standard display, specified values are always shown at the bottom of the display.</p>	
<p>Loudspeaker Switch loudspeaker on and off. In the event of error messages, a signal tone sounds even if the loudspeaker is switched off.</p>	<p>On</p> <p>Off</p>	<p>Switch on loudspeaker.</p> <p>Switch off loudspeaker.</p>	<p></p> <p></p>
<p>Volume Adjust the speaker volume using the menu arrow keys  and  in 5 stages. The signal tone for error messages is always issued at least at medium volume.</p>	<p>Cancel</p> <p>Save</p> <p>Default</p>	<p>Exit menu item without saving.</p> <p>Save volume just set.</p> <p>Restore default volume.</p>	
<p>Date/time Set date and time. The system does not switch automatically between summer and winter time.</p>		<p>In the date display, set year (YYYY), month (MM) and day (DD). In the time display, set hours (hh) and minutes (mm). Before setting the clock time the time format is selected (12 h / 24 h).</p>	
<p>Contrast Adjust the display contrast using the menu arrow keys  and .</p>	<p>Cancel</p> <p>Save</p> <p>Default</p>	<p>Exit menu item without saving.</p> <p>Save the contrast just set.</p> <p>Restore default contrast.</p>	
<p>Language</p>		<p>Set menu language (English, Deutsch, Français or Español) . (see <i>Set menu language on p. 30</i>).</p>	
<p>Standby Switch standby mode on and off. If the centrifuge is not used during the set time period and no continuous cooling takes place (only 5430 R), it switches to the standby mode (see p. 41).</p>	<p>On</p> <p>Off</p> <p>Set time</p>	<p>Switch on standby mode.</p> <p>Switch off standby mode.</p> <p>Using the arrow keys, set the time after which the centrifuge should automatically change to the standby mode (1 to 60 min).</p>	
<p>Lid release (only 5430)</p>	<p>Automatic</p> <p>Manual</p>	<p>Lid opens automatically at the end of centrifuging when the rotor stops.</p> <p>Lid remains closed at the end of centrifuging when the rotor stops and can be opened using the now flashing key open.</p>	

7 Maintenance

7.1 Prepare cleaning/disinfection

- ▶ Clean all accessible surfaces of the device and the accessories at least weekly and when contaminated.
- ▶ Clean the rotor regularly. This way the rotor is protected and the durability is prolonged.
- ▶ Furthermore, observe the notes on decontamination (see *Decontamination before shipment on p. 53*) when the device is sent to the authorized Technical Service for repairs.

The procedure described in the following chapter applies to the cleaning as well as to the disinfection or decontamination. The table below describes the steps required on top of this:

Cleaning	Disinfecting/decontamination
<ol style="list-style-type: none"> 1. Use a mild cleaning fluid to clean the accessible surfaces of the device and the accessories. 2. Carry out the cleaning as described in the following chapter. 	<ol style="list-style-type: none"> 1. Choose the disinfection method which corresponds to the legal regulations and guidelines in place for your range of application. For example, use alcohol (ethanol, isopropanol) or alcohol-based disinfectants. 2. Carry out the disinfection or decontamination as described in the following chapter. 3. Then clean the device and the accessories.



If you have any further questions regarding the cleaning and disinfection or decontamination or regarding the cleaning fluid to be used, contact the Eppendorf AG Application Support. The contact details are provided on the back of this manual.

7.2 Cleaning/disinfection



DANGER! Electric shock as a result of penetration of liquid.

- ▶ Switch off the device and disconnect the power plug before starting cleaning or disinfection work.
- ▶ Do not allow any liquids to penetrate the inside of the housing.
- ▶ Do not spray clean/spray disinfect the housing.
- ▶ Only plug the device back in if it is completely dry, both inside and outside.



NOTICE! Damage from the use of aggressive chemicals.

- ▶ Do not use any aggressive chemicals on the device or its accessories, such as strong and weak bases, strong acids, acetone, formaldehyde, halogenated hydrocarbons or phenol.
- ▶ If the device has been contaminated by aggressive chemicals, clean it immediately using a mild cleaning agent.



NOTICE! Corrosion due to aggressive cleaning agents and disinfectants.

- ▶ Do not use corrosive cleaning agents, aggressive solvents or abrasive polishes.
- ▶ Do not incubate the accessories in aggressive cleaning agents or disinfectants for longer periods.



NOTICE! Damage from UV and other high-energy radiation.

- ▶ Do not use UV, beta, gamma, or any other high-energy radiation for disinfecting.
- ▶ Avoid storage in areas with strong UV radiation



Autoclaving

All rotors, rotor lids and adapters, except the A-2-MTP rotor, can be autoclaved (121 °C, 20 min).

Replace the lids of the aerosol-tight rotors after a maximum of 50 autoclaving cycles.

Only QuickLock rotor lid: Only the seal needs to be replaced after a maximum of 50 autoclaving cycle.



Swing-bucket rotor

- Before cleaning the rotor, remove old pivot grease from grooves and pivots.
- Make sure that the grooves and pivots are clean. Dirty grooves and pivots prevent carriers from swinging out evenly.
- After cleaning, lubricate the pivots of the rotor and the grooves of the buckets with pivot grease (order no. Int.: 5810 350.050/North America: 022634330) so that the carriers can move freely in a swinging manner.

7.2.1 Cleaning and disinfecting the device

1. Open the lid. Switch off the device with the mains/power switch. Disconnect the power plug from the power supply.
2. Loosen the rotor nut by turning the rotor key **counterclockwise**.
3. Remove the rotor.
4. Clean and disinfect all accessible surfaces of the device, including the power cable, using a damp cloth and the recommended cleaning agents.
5. Thoroughly clean the rubber seals of the rotor chamber with water.
6. Rub the dry rubber seal with glycerine or talcum powder to prevent it from becoming brittle. Other components of the device, such as the lid latch, lid springs, motor shaft and rotor cone, must not be lubricated.
7. Clean the motor shaft with a soft, dry and lint-free cloth. Do not lubricate the motor shaft.
8. Check the motor shaft for damage.
9. Inspect the device for corrosion and damage.
10. Leave the centrifuge lid open when the device is not being used.
11. Only connect the device to the power supply if it is fully dry inside and out.

7.2.2 Cleaning and disinfecting the rotor

1. Inspect the rotor and accessories for damage and corrosion. Do not use any damaged rotors or accessories.
2. Clean and disinfect the rotors and accessories with the recommended cleaning agents.
3. Use a bottle brush to clean and disinfect the rotor bores.

4. Clean and disinfect the rotor lids.

ONLY QuickLock: It is imperative that the sealing ring be removed during this process so that the groove below it can be thoroughly cleaned.

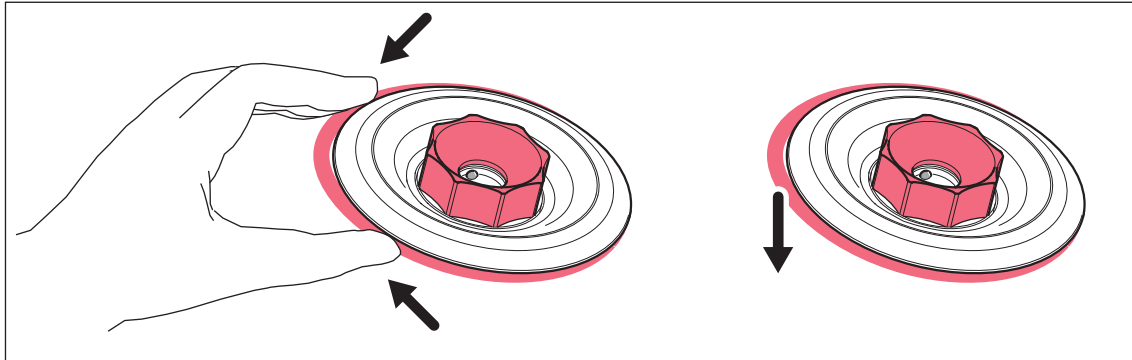

5. Rinse the rotors and accessories thoroughly with distilled water. Rinse the rotor bores of fixed-angle rotors particularly thoroughly.



Do not immerse the rotor in liquid as liquid can get trapped inside the cavities.

6. Place rotors and accessories on a cloth to dry. Place fixed-angle rotors with the rotor bores facing downwards to allow the bores to also dry.
7. Correctly reinsert the rotor lid sealing ring in the clean and dry groove.
8. Clean the rotor cone with a soft, dry and lint-free cloth. Do not lubricate the rotor cone.
9. Inspect the rotor cone for damage.
10. Place the dry rotor onto the motor shaft.
11. Tighten the rotor nut firmly by turning it **clockwise** with the rotor key.
12. Load the fixed-angle rotor with the cleaned adapters or the swing-bucket rotor with the cleaned buckets and adapters, if necessary.
13. Leave the rotor lid open when the rotor is not being used.

7.3 Additional service instructions for Centrifuge 5430 R

- ▶ Empty and clean the condensation water tray regularly and especially after liquid spillage in the rotor chamber. Pull out the tray for condensation water from the left side of the centrifuge.
- ▶ Clean the condensation water drain on a regular basis, e.g., using a bottle brush.
- ▶ Regularly free the rotor chamber ice formations via thawing, by leaving the centrifuge lid open or carrying out a short temperature control run at approx. 30 °C.
- ▶ Leave the centrifuge lid open when not in use for a long period.
- ▶ Wipe up condensate in the rotor chamber using a soft, absorbent cloth.
- ▶ Remove dust deposits from the ventilation slits of the centrifuge using a brush or swab at the latest every six months. First switch off the device and remove the power plug.
- ▶ Regularly check the gas spring of the centrifuge lid for proper functioning.
A defective gas spring is an insufficient support for the centrifuge lid and could cause injury if the centrifuge lid falls down. We recommend that the gas spring be replaced by a service technician every 2 years.

7.4 Glass breakage

When using glass tubes there is a risk of glass breakage in the rotor chamber. The resulting glass splinters are swirled around in the rotor chamber during centrifugation and have a sandblasting effect on the rotor and accessories. The smallest glass particles become lodged in the rubber parts (e.g., the motor guide, the rotor chamber gasket, and the rubber mats of adapters).



NOTICE! Glass breakage in the rotor chamber

Glass tubes in the rotor chamber may break if the *g*-force is too high. Broken glass can damage the rotor, accessories and samples.

- ▶ Please note the manufacturer's information on the recommended centrifugation parameters (load and speed).

Effects of glass breakage in the rotor chamber:

- Fine black metal abrasion in the rotor chamber (in metal rotor chambers)
- The surfaces of the rotor chamber and accessories are scratched.
- The chemical resistance of the rotor chamber is reduced.
- Contamination of samples
- Wear on rubber parts

How to proceed in case of glass breakage

1. Remove all splinters and glass powder from the rotor chamber and accessories.
2. Thoroughly clean the rotor and rotor chamber. Thoroughly clean the bores of the fixed-angle rotors, in particular.
3. If required, replace rubber mats and adapters to prevent any further damage.
4. Regularly check the rotor bores for deposits and damage.

7.5 Fuses

The fuse holder is located under the mains power socket.

1. Pull out the power plug.
2. Remove the fuse holder towards the rear.
The two fuses can now be reached. The fuses can be replaced.

Instead of removable fuses, the Centrifuge 5430 R features a thermal overcurrent protective switch. The mains power switch jumps to the '0' switch setting if the overcurrent protective switch is triggered.

1. Use the mains power switch to switch the device back on after more than 20 s.
2. If the mains power switch returns to the '0' switch setting, contact Technical Support.

7.6 Decontamination before shipment

If you are shipping the device to the authorized Technical Service for repairs or to your authorized dealer for disposal please note the following:



WARNING! Risk to health from contaminated device

1. Follow the instructions in the decontamination certificate. It is available as a PDF file on our webpage (www.eppendorf.com/decontamination).
2. Decontaminate all the parts you would like to dispatch.
3. Include the fully completed decontamination certificate in the package.

8 Troubleshooting

If you cannot remedy an error with the recommended measures, please contact your local Eppendorf partner. The contact address can be found online at: www.eppendorf.com.

8.1 General errors

Symptom/message	Cause	Remedy
No display.	No power connection.	▶ Check mains/power connection.
No display.	Power failure.	▶ Check the mains fuse of the device (see <i>Fuses on p. 53</i>). ▶ Check the mains fuse of the laboratory.
Lid of the device cannot be opened.	Rotor is still running.	▶ Wait for rotor to stop.
Lid of the device cannot be opened.	Power failure.	1. Check the mains fuse of the device (see <i>Fuses on p. 53</i>). 2. Check the mains fuse of the laboratory. 3. Activate the emergency lid release (see p. 57).
Device cannot be started.	Lid of the device is not closed.	▶ Close device lid.
Device shakes when it starts up.	Rotor loaded unsymmetrically.	1. Stop the device and load symmetrically. 2. Restart device.
Centrifuge brakes during a short run centrifugation, although the short key is pressed.	The short key was released briefly more than twice (protective function for the drive).	▶ Press the short key continuously during a short run centrifugation.
Temperature display flashes. (only for 5430 R)	Temperature deviation from the set value: ± 3 °C.	▶ Check the settings. ▶ Check unhindered air circulation through the air slots. ▶ Thaw ice or switch off device and allow it to cool down.

8.2 Error messages

If one of the following error messages appears, proceed as follows:

1. Remove fault (see Remedies).
2. Press **open** key to clear the error message.
3. If necessary, repeat centrifugation.

Some errors can have various causes. The actual cause is described in the message in the device display.

Symptom/message	Cause	Remedy
<i>Note A</i> <i>Lid latch</i>	Centrifuge lid could not be locked.	▶ Try again to close centrifuge lid.
<i>Note B</i> <i>Imbalance</i>	Rotor loaded unsymmetrically.	▶ Load the rotor symmetrically and balance it.
<i>Note C</i> <i>Rotor detection</i>	Set g-force/speed too high, e.g. after a rotor change (see <i>Automatic rotor detection on p. 32</i>).	<ol style="list-style-type: none"> 1. Check the g-force/speed. 2. Repeat the run.

Symptom/message	Cause	Remedy
<i>Error 1</i> <i>Rotor detection</i>	Rotor not detected.	<ul style="list-style-type: none"> ▶ Check rotor. ▶ If this error message appears again, test with a different rotor.
<i>Error 2</i> <i>Electronics fault</i>	Electronics fault.	▶ Switch centrifuge off and back on again after > 20 s.
<i>Error 3</i> <i>Speed control</i>	Error in speed measuring system.	▶ Insert and tighten rotor.
<i>Error 3</i> <i>Speed control</i>	Error in speed measuring system.	▶ Wait for displayed time.
<i>Error 5</i> <i>Lid latch</i>	Prohibited opening of lid or lid switch is defective during a run.	<ol style="list-style-type: none"> 1. Wait for rotor to stop. 2. Open and close again the lid of the device. 3. Repeat the run.
<i>Error 6</i> <i>Drive fault</i>	Drive fault.	<ul style="list-style-type: none"> ▶ Repeat the run. ▶ If this error message appears again, switch centrifuge off and back on again after > 20 s.
<i>Error 6</i> <i>Drive fault</i>	Drive overheated.	▶ Allow the drive to cool down for at least 15 min.
<i>Error 7</i> <i>Speed control</i>	Major deviation in the speed control.	<ol style="list-style-type: none"> 1. Wait for rotor to stop. 2. Tighten rotor.
<i>Error 8</i> <i>Speed control</i>	<ul style="list-style-type: none"> • Drive fault. • Rotor loose. • Incorrect rotor. 	<ol style="list-style-type: none"> 1. Wait for rotor to stop. 2. Tighten rotor. 3. Repeat the run.
<i>Error 9 to Error 14</i>	Electronics fault.	▶ Switch centrifuge off and back on again after > 20 s.

Symptom/message	Cause	Remedy
<i>Error 16 to Error 17</i> <i>Electronics fault</i>	Electronics fault.	▶ Switch centrifuge off and back on again after > 20 s.
<i>Error 18</i> <i>Room Temp. of rotor chamber</i> (only 5430 R)	Temperature deviation from set value in the rotor chamber: $\Delta T > 16$ °C.	▶ Allow the device to cool down and repeat cycle.
<i>Error 18</i> <i>Room Temp. of rotor chamber</i> (only 5430 R)	Temperature deviation from set value in the rotor chamber: $\Delta T > 50$ °C.	▶ Allow the device to cool down and repeat cycle.
<i>Error 22</i> <i>Electronics fault</i> (only 5430 R)	Electronics fault.	▶ Switch centrifuge off and back on again after > 20 s.
<i>Error 25</i> <i>Mains/power failure</i>	Mains/power failure during a run.	▶ Check the power supply.
<i>Error 26</i> <i>Electronics fault</i> (only 5430 R)	Electronics fault.	▶ Switch centrifuge off and back on again after > 20 s.
<i>Error 27</i> <i>Electronics fault</i> (only 5430 R)	Electronics fault.	▶ Switch centrifuge off and back on again after > 20 s.
<i>Error 28</i> <i>Electronics fault</i>	Electronics fault.	▶ Press the open key.
<i>Error 30</i> <i>Lid latch</i>	Centrifuge lid could not be locked.	▶ Try again to close centrifuge lid.
<i>Error 30</i> <i>Lid latch</i>	Centrifuge lid could not be released.	▶ Switch the device off and back on again. If the error occurs again: 1. Switch off the device. 2. Activate the emergency lid release (see <i>Emergency release on p. 57</i>).
<i>Error 30</i> <i>Lid latch</i>	Centrifuge lid has not been opened wide enough.	▶ Open the centrifuge lid wider by hand.

8.3 Emergency release

If the centrifuge lid cannot be opened, you can activate the emergency release manually.



WARNING! Risk of injury from rotating rotor.

If the emergency release of the lid is operated, the rotor may continue rotating for several minutes.

- ▶ Wait until the rotor stop before operating the emergency release.
- ▶ Check the monitoring glass in the centrifuge lid.



Use the rotor key delivered with the Centrifuge 5430 for the emergency release.

The rotor key for the rotor FA-45-24-11-HS is not suitable for this purpose.

1. Pull the mains/power plug.
2. Carry out the following steps for the emergency release on both the left side and right side of the centrifuge (see Fig. 1 and Fig. 2).
3. **Only 5430:** Remove the plastic cover for the emergency release.
4. Insert the centrifuge rotor key in the rear hexagonal opening until a noticeable resistance is felt.
5. **Slightly press** and turn the rotor key counterclockwise five to ten revolutions, as depicted on the openings of the emergency release.

This will release the centrifuge lid.

6. Open the centrifuge lid.
7. Remove the rotor key and put the plastic covers back on (Centrifuge 5430).

9 Transport, storage and disposal

9.1 Transport



CAUTION! Risk of injury due to lifting and carrying heavy loads

The device is heavy. Lifting and carrying the device can lead to back injuries.

- ▶ Transport and lift the device with an adequate number of helpers only.
- ▶ Use a transport aid to transport the device.

- ▶ Remove the rotor from the centrifuge before transport.
- ▶ Use the original packaging for transport.

	Air temperature	Relative humidity	Atmospheric pressure
General transport	-25 °C – 60 °C	10 % – 75 %	30 kPa – 106 kPa
Air freight	-20 °C – 55 °C	10 % – 75 %	30 kPa – 106 kPa

9.2 Storage

	Air temperature	Relative humidity	Atmospheric pressure
In transport packaging	-25 °C – 55 °C	10 % – 75 %	70 kPa – 106 kPa
Without transport packaging	-5 °C – 45 °C	10 % – 75 %	70 kPa – 106 kPa

9.3 Disposal

In case the product is to be disposed of, the relevant legal regulations are to be observed.

Information on the disposal of electrical and electronic devices in the European Community:

Within the European Community, the disposal of electrical devices is regulated by national regulations based on EU Directive 2002/96/EC pertaining to waste electrical and electronic equipment (WEEE).

According to these regulations, any devices supplied after August 13, 2005, in the business-to-business sphere, to which this product is assigned, may no longer be disposed of in municipal or domestic waste. To document this, they have been marked with the following identification:



Because disposal regulations may differ from one country to another within the EU, please contact your supplier if necessary.

10 Technical data

10.1 Power supply

Centrifuge 5430

Mains connection	230 V, 50 to 60 Hz 120 V, 50 to 60 Hz 100 V, 50 to 60 Hz
Current consumption	3 A (230 V) 6 A (120 V) 7 A (100 V)
Power consumption	Maximum 475 W
EMC: interference emission (radio interference)	EN 61326 - category B
EMC: noise immunity	EN 61326
Overvoltage category	II
Protection class	1
Fuses	4.0 AT (230 V) 8.0 AT (120 V/100 V)

Centrifuge 5430 R

Mains connection	230 V, 50 to 60 Hz 120 V, 50 to 60 Hz 100 V, 50 to 60 Hz
Current consumption	6 A (230 V) 12 A (120 V/ 100 V)
Power consumption	Maximum 1050 W
EMC: Interference emission (radio interference)	EN 61326 – Class B (230 V/120 V) EN 61326 – Class A (100 V)
EMC: Noise immunity	EN 61326
Overvoltage category	II
Protection class	1
Fuses	Thermal overcurrent protective switch 7 A (230 V) Thermal overcurrent protective switch 15 A (120 V/100 V)

10.2 Ambient conditions

Ambience	For indoor use only.
Ambient temperature	Centrifuge 5430: 4 to 40°C Centrifuge 5430 R: 10 to 40°C
Maximum relative humidity	75 %, non-condensing humidity
Atmospheric pressure	Use up to an altitude of 2000 m above MSL.
Degree of pollution	2

10.3 Weight/dimensions

Centrifuge 5430

Dimensions	Width: 335 mm (11.2 in.) Depth: 415 mm (16.3 in.) Height: 250 mm (9.84 in.)
Weight without rotor	29 kg (63.9 lbs.)
Noise level	< 60 dB(A) *

Centrifuge 5430 R

Dimensions	Width: 380 mm (15.0 in.) Depth: 640 mm (25.2 in.) Height: 296 mm (11.7 in.)
Weight without rotor	56 kg (123.5 lbs.)
Noise level	< 60 dB(A) *

*) The noise level was measured frontally in a sound measuring room with accuracy class 1, 1 m from the device and at lab bench height.

10.4 Application parameters

Run time	30 s to 99:59 h, infinity (∞) Adjustable to 10 min in 0.5 min increments, then increments of 1 min
Temperature of 5430 R	-11°C to 40°C
Relative centrifugal force (or rcf)	1 to 30.130 × g Adjustable in increments of 10 × g up to 3,000 × g, then in increments of 100 × g
Speed	100 to 17,500 rpm Adjustable in increments of 10 rpm up to 5,000 rpm, then in increments of 100 rpm
Maximum load	48 tubes with 2.0 mL each or 6 conical tubes with 50 mL each
Maximum kinetic energy	10,000 nm
Compulsory test log book	No
Permitted density of the material for centrifuging at max. g-force/rpm and max. load	1.2 g/mL

Rotor	Lowest achievable temperature -11°C set 23°C ambient temperature 60 min run time	Speed to safely maintain 4°C sample temperature 4°C set 23 °C ambient temperature
FA-45-48-11	< 0 °C	12700 rpm
F-45-48-11	< 0 °C	12700 rpm
FA-45-30-11	< 0 °C	14000 rpm
F-45-30-11	< 0 °C	14000 rpm
FA-45-24-11-HS	< 5 °C	? rpm
FA-45-24-11-Kit	< 0 °C	13200 rpm
F-45-64-5-PCR	< 0 °C	11800 rpm
F-45-18-17-Cryo	< 0 °C	8900 rpm
FA-45-16-17	< 0 °C	14200 rpm
F-35-6-30	< 0 °C	78300 rpm
A-2-MTP	< 0 °C	4680 rpm
S-24-11-AT	< 0 °C	12700 rpm

Acceleration times and braking times of Centrifuge 5430/5430 R

Rotor	Acceleration time/Deceleration time Without soft ramp		
	Acceleration time/Deceleration time With soft ramp		
	230 V	120 V	100 V
FA-45-48-11	≤ 20 / 20 s	≤ 20 / 20 s	≤ 27 / 20 s
F-45-48-11	≤ 61 / 65 s (SOFT)	≤ 61 / 65 s (SOFT)	≤ 61 / 65 s (SOFT)
FA-45-30-11	≤ 15 / 15 s	≤ 15 / 15 s	≤ 20 / 15 s
F-45-30-11	≤ 61 / 65 s (SOFT)	≤ 61 / 65 s (SOFT)	≤ 61 / 65 s (SOFT)
FA-45-24-11-Kit	≤ 15 / 16 s ≤ 78 / 90 s (SOFT)	≤ 15 / 16 s ≤ 78 / 90 s (SOFT)	≤ 20 / 16 s ≤ 78 / 90 s (SOFT)
FA-45-16-17	≤ 20 / 20 s ≤ 61 / 66 s (SOFT)	≤ 20 / 20 s ≤ 61 / 66 s (SOFT)	≤ 30 / 20 s ≤ 61 / 66 s (SOFT)
S-24-11-AT	≤ 13 / 16 s ≤ 61 / 66 s (SOFT)	≤ 13 / 16 s ≤ 61 / 66 s (SOFT)	≤ 16 / 16 s ≤ 61 / 66 s (SOFT)
FA-45-24-11-HS	≤ 21 / 16 s ≤ 60 / 65 s (SOFT)	≤ 21 / 16 s ≤ 60 / 65 s (SOFT)	≤ 30 / 16 s ≤ 60 / 65 s (SOFT)
F-45-64-5-PCR	≤ 12 / 15 s ≤ 62 / 65 s (SOFT)	≤ 12 / 15 s ≤ 62 / 65 s (SOFT)	≤ 15 / 15 s ≤ 62 / 65 s (SOFT)
F-45-18-17-Cryo	≤ 8 / 11 s ≤ 77 / 85 s (SOFT)	≤ 8 / 11 s ≤ 77 / 85 s (SOFT)	≤ 8 / 11 s ≤ 77 / 85 s (SOFT)
F-35-6-30	≤ 23 / 23 s ≤ 62 / 67 s (SOFT)	≤ 23 / 23 s ≤ 62 / 67 s (SOFT)	≤ 27 / 27 s ≤ 62 / 67 s (SOFT)
A-2-MTP	≤ 18 / 21 s ≤ 63 / 67 s (SOFT)	≤ 18 / 21 s ≤ 63 / 67 s (SOFT)	≤ 18 / 21 s ≤ 63 / 67 s (SOFT)

11 Ordering Information

11.1 Centrifuge 5430

Order no. (International)	Order no. (North America)	Description
5427 000.011 –	022620533 022620584	Centrifuge 5430, Keypad without rotor 230 V / 50 – 60 Hz 120 V / 50 – 60 Hz, with US-plug
5427 000.216 –	022620525 022620509	Centrifuge 5430, Keypad with rotor FA-45-30-11 incl. rotor lid 230 V / 50 – 60 Hz 120 V / 50 – 60 Hz, with US-plug
–	022620541	Centrifuge 5430, Keypad with rotor FA-45-24-11-Kit incl. rotor lid 120 V / 50 – 60 Hz, with US-plug
–	022620568	Centrifuge 5430, Keypad with rotor A-2-MTP incl. wind shield upper shell 120 V / 50 – 60 Hz, with US-plug
5427 000.615 –	022620540 022620596	Centrifuge 5430, Knobs without rotor 230 V / 50 – 60 Hz 120 V / 50 – 60 Hz, with US-plug
5427 000.410 –	- 022620511	Centrifuge 5430, Knobs with rotor FA-45-30-11 incl. rotor lid 230 V / 50 – 60 Hz 120 V / 50 – 60 Hz, with US-plug
–	022620557	Centrifuge 5430, Knobs with rotor FA-45-24-11-Kit incl. rotor lid 120 V / 50 – 60 Hz, with US-plug
–	022620572	Centrifuge 5430, Knobs with rotor A-2-MTP incl. wind shield upper shell 120 V / 50 – 60 Hz, with US-plug

11.2 Centrifuge 5430 R

Order no. (International)	Order no. (North America)	Description
5428 000.210 –	022620678 022620667	Centrifuge 5430 R, Keypad without rotor 230 V / 50 – 60 Hz 120 V / 50 – 60 Hz, with US-plug
5428 000.015 –	022620612 022620601	Centrifuge 5430 R, Keypad with rotor FA-45-30-11 incl. rotor lid 230 V / 50 – 60 Hz 120 V / 50 – 60 Hz, with US-plug

Order no. (International)	Order no. (North America)	Description
–	022620645	Centrifuge 5430 R, Keypad with rotor A-2-MTP incl. wind shield upper shell 120 V / 50 – 60 Hz, with US-plug
5428 000.619 –	022620690 022620689	Centrifuge 5430 R, Knobs without rotor 230 V / 50 – 60 Hz 120 V / 50 – 60 Hz, with US-plug
5428 000.414 –	022620634 022620623	Centrifuge 5430 R, Knobs with rotor FA-45-30-11 incl. rotor lid 230 V / 50 – 60 Hz 120 V / 50 – 60 Hz, with US-plug
–	022620656	Centrifuge 5430 R, Knobs with rotor A-2-MTP incl. wind shield upper shell 120 V / 50 – 60 Hz, with US-plug

11.3 Rotors, rotor lids and seals

11.3.1 Rotors with QuickLock rotor lid

Rotor FA-45-48-11

Order no. (International)	Order no. (North America)	Description
5427 754.008	5427754008	Fixed-angle rotor FA-45-48-11 aerosol-tight, angle 45°, 48 places, max. tube diameter 11 mm, incl. rotor lid (aluminum)
5427 762.000	5427762000	Rotor lid for FA-45-48-11 aerosol-tight, aluminum
5409 718.002	5409718002	Seal for rotor lid FA-45-48-11 (5427 R/5430/5430 R) set of 5 pieces

Rotor FA-45-30-11

Order no. (International)	Order no. (North America)	Description
5427 753.001	5427753001	Fixed-angle FA-45-30-11 aerosol-tight, angle 45°, 30 places, max. tube diameter 11 mm, incl. rotor lid (aluminum)
5427 761.004	5427761004	Rotor lid for FA-45-30-11 aerosol-tight, aluminum
5820 762.004	5820762004	Seal for rotor lid FA-45-30-11 (5427 R/5430/5430 R) Set of 5 pieces

Rotor FA-45-24-11 Kit

Order no. (International)	Order no. (North America)	Description
5427 752.005	5427752005	Fixed-angle rotor FA-45-24-11-Kit aerosol-tight, angle 45°, 24 places, max. tube diameter 11 mm, incl. rotor lid (aluminum)
5427 760.008	5427760008	Rotor lid for FA-45-24-11-Kit aerosol-tight, aluminum
5820 767.006	5820767006	Seal for rotor lid FA-45-24-11-Kit (5427 R/5430/5430 R), FA-45-48-11, FA-45-20-17 (5804/5804 R/5810/5810 R) Set of 5 pieces

Rotor FA-45-16-17

Order no. (International)	Order no. (North America)	Description
5427 750.002	5427750002	Fixed-angle rotor FA-45-16-17 aerosol-tight, angle 45°, 16 places, max. tube diameter 17 mm, incl. rotor lid (aluminum)
5427 751.009	5427751009	Rotor lid for FA-45-16-17 aerosol-tight, aluminum
5409 717.006	5409717006	Seal for rotor lid FA-45-24-11 (5427 R), FA-45-16-17 (5430/5430 R) Set of 5 pieces

Rotor S-24-11-AT

Order no. (International)	Order no. (North America)	Description
5427 757.007	5427757007	Swing-bucket rotor S-24-11-AT aerosol-tight, steel, angle 90°, 24 places, max. tube diameter 11 mm, incl. rotor lid (aluminum)
5427 758.003	5427758003	Rotor lid for S-24-11-AT aerosol-tight, aluminum
5409 719.009	5409719009	Seal for rotor lid S-24-11-AT (5427 R/5430/5430 R) set of 5 pieces
5409 721.003	5409721003	Tube holder for S-24-11-AT for 4 × 1,5 mL/2,0 mL Eppendorf tubes set of 2 pieces

11.3.2 Rotors with rotor lid thread

Rotor F-45-48-11

Order no. (International)	Order no. (North America)	Description
5409 712.004	5409712004	Rotor F-45-48-11 aluminum, angle 45°, 48 places, max. tube diameter 11 mm, incl. rotor lid (polypropylene)
5409 713.000	5409713000	Rotor lid for F-45-48-11 Polypropylene

Rotor FA-45-30-11

Order no. (International)	Order no. (North America)	Description
5427 719.008	022654063	Rotor lid for F-45-30-11 aerosol-tight, PTFE-coated, aluminum

Rotor F-45-30-11

Order no. (International)	Order no. (North America)	Description
5427 712.003	022654004	Rotor F-45-30-11 PTFE-coated, angle 45°, 30 places, max. tube diameter 11 mm, incl. rotor lid (polypropylene)
5427 718.001	022654021	Rotor lid for F-45-30-11 Polypropylene

Rotor FA-45-24-11-HS

Order no. (International)	Order no. (North America)	Description
5427 710.000	022654080	Rotor FA-45-24-11-HS aerosol-tight, PTFE-coated, angle 45°, 24 places, max. tube diameter 11 mm, incl. rotor lid (aluminum), incl. rotor key
5427 711.007	022654101	Rotor lid for FA-45-24-11-HS aerosol-tight, PTFE-coated, aluminum

Rotor FA-45-24-11-Kit

Order no. (International)	Order no. (North America)	Description
5427 704.000	022654144	Rotor lid for FA-45-24-11-Kit aerosol-tight, aluminum

Rotor F-45-64-5-PCR

Order no. (International)	Order no. (North America)	Description
5427 714.006	022654209	Rotor F-45-64-5-PCR angle 45°, 64 places, max. tube diameter 5 mm, incl. rotor lid (aluminum) and adapters
5427 720.006	022654225	Rotor lid for F-45-64-5-PCR aluminum

Rotor F-45-18-17-Cryo

Order no. (International)	Order no. (North America)	Description
5427 705.007	022654161	Rotor F-45-18-17-Cryo angle 45°, 18 places, max. tube diameter 17 mm, incl. rotor lid (polypropylene) and adapters
5427 707.000	022654187	Rotor lid for F-45-18-17-Cryo Polypropylene

Rotor F-35-6-30

Order no. (International)	Order no. (North America)	Description
5427 716.009	022654306	Rotor F-35-6-30 angle 35°, 6 places, max. tube diameter 30 mm, incl. rotor lid (aluminum) and adapters for 15/50 mL conical tubes
5427 739.009	5427739009	angle 35°, 6 places, max. tube diameter 30 mm, incl. rotor lid
5427 715.002	022654322	Rotor lid for F-35-6-30 aluminum

11.3.3 Rotors with rotor lid for attaching

A-2-MTP rotor

Order no. (International)	Order no. (North America)	Description
5427 700.005	022634403	Rotor A-2-MTP with 2 buckets and windshield upper shell
5427 722.009	022634420	Spare MTP buckets for A-2-MTP Set of 2
5427 725.008	022654446	Wind shield upper shell for A-2-MTP aluminum



The Aerosol tightness is tested and certified by the Centre of Emergency Preparedness and Response, Health Protection Agency, Porton Down (UK).

11.4 Accessories

11.4.1 Adapter

Order no. (International)	Order no. (North America)	Description
5425 715.005 5425 717.008 5425 716.001	022636260 022636243 022636227	Adapter used in FA-45-48-11, F-45-48-11, FA-45-30-11, F-45-30-11, FA-45-24-11-HS and FA-45-24-11-Kit for 1 PCR tube (0.2 mL, max. Ø 6 mm), set of 6 for 1 sample tube (0.4 mL, max. Ø 6 mm), set of 6 for 1 sample tube (0.5 mL, max. Ø 6 mm) or 1 Microtainer (0.6 mL, max. Ø 8 mm), set of 6
5427 717.005	022654241	Adapter used in F-45-64-5-PCR for PCR strips, set of 4 pieces
5702 752.002 5427 708.006	022639498 5427708006	Adapter used in F-45-18-17-Cryo for cryo tubes (max. Ø 13 mm) and sealable centrifuge tubes (max. Ø 12.2 mm), max. length 50 mm, set of 6 for 1.5 mL HPLC vials, 18 pieces
5427 740.007 5427 741.003 5427 746.005 5427 726.004 5427 732.004 5427 735.003	5427740007 5427741003 5427746005 022654365 022654512 022654538	Adapter used in F-35-6-30, small tube bore 13 × 65-89, set of 2 13 × 90-110, set of 2 for Eppendorf Tubes 5.0 mL, set of 2 for 15 mL conical tubes, set of 2 for 7 - 15 mL round-bottom tubes and blood collection tubes, set of 2 for 9 - 15 mL round-bottom tubes and blood collection tubes, set of 2
5427 742.000	5427742000	Adapter used in F-35-6-30, large tube bore 13 × 65-89, set of 2

Ordering Information
Centrifuge 5430/5430 R
English (EN)

Order no. (International)	Order no. (North America)	Description
5427 743.006	5427743006	13 × 90-110, set of 2
5427 747.001	5427747001	for Eppendorf Tubes 5.0 mL, set of 2
5427 727.000	022654349	for 50 mL conical tubes, set of 2
5427 723.005	022654331	for Centriplus centrifugal filter units, set of 6
5427 734.007	022654524	for 7 - 15 mL round-bottom tubes and blood collection tubes, set of 2
5427 738.002	022654545	for 9 - 15 mL round-bottom tubes and blood collection tubes, set of 2
5427 736.000	022654556	for 20 - 30 mL round-bottom tubes, set of 2
5427 737.006	022654567	for 50 mL round-bottom tubes, set of 2
		Adapter
5825 711.009	022638947	used in A-2-MTP
5825 713.001	022638955	for 96-well PCR plates, set of 2
5825 706.005	022638963	for 384-well PCR plates, set of 2 CombiSlide Adapter, set of 2

11.4.2 Other accessories

Order no. (International)	Order no. (North America)	Description
5416 301.001	022634305	Rotor key
5427 730.001	5427730001	Standard for rotor FA-45-24-11-HS
5427 728.007	5427728007	Rotor removal tool for Rotor F-35-6-30
5810 350.050	022634330	Pivot grease Tube 20 mL
5428 850.418	022680452	Tray for condensation water

11.4.3 Fuses for Centrifuge 5430

Order no. (International)	Order no. (North America)	Description
5301 850.249	022654403	Fuse 4 A (230 V), 2 pieces
5427 850.341	022654381	8.0 AT UL (120 V/100 V), 2 pieces

Declarations and Certificates

EG-Konformitätserklärung EC Conformity Declaration

Das bezeichnete Produkt entspricht den einschlägigen grundlegenden Anforderungen der aufgeführten EG-Richtlinien und Normen. Bei einer nicht mit uns abgestimmten Änderung des Produktes oder einer nicht bestimmungsgemäßen Anwendung verliert diese Erklärung ihre Gültigkeit.

The product named below fulfills the relevant fundamental requirements of the EC directives and standards listed. In the case of unauthorized modifications to the product or an unintended use this declaration becomes invalid.

Produktbezeichnung, Product name:

Centrifuge 5430 / 5430 R

einschließlich Zubehör / including accessories

Produkttyp, Product type:

Laborzentrifuge / Laboratory Centrifuge

Einschlägige EG-Richtlinien/Normen, Relevant EC directives/standards:

2006/95/EG, EN 61010-1, EN 61010-2-20

2011/65/EU

2004/108/EG, EN 55011/B, EN 61000-6-1, EN 61000-3-2, EN 61000-3-3, EN 61326-1

98/79/EG, EN 14971, EN 61010-2-101, EN 61326-2-6, EN 62366, EN 18113-3

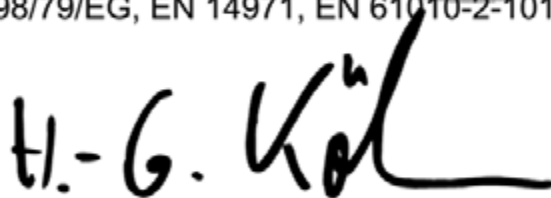

Vorstand, Board of Management:

14.08.2012

Hamburg, Date:



Projektmanagement, Project Management:

eppendorf



Eppendorf AG · Barkhausenweg 1 · 22339 Hamburg · Germany

Certificate of Compliance

Certificate Number: 090806 - E215059
Report Reference: E215059, June 9th, 2006
Issue Date: 2006 August 9

Page 1 of 2



**Underwriters
Laboratories Inc.®**

Issued to: **EPPENDORF A G**
BARKHAUSENWEG 1
D-22339 HAMBURG GERMANY

This is to certify that
representative samples of **Centrifuge**
Model: 5430

Have been investigated by Underwriters Laboratories Inc.® in
accordance with the Standard(s) indicated on this Certificate.

Standard(s) for Safety: **See Addendum for Safety**

Additional Information: **ELECTRICAL RATING:**
Voltage: 120 V ac
Frequency: 50-60 Hz
Current: 6 A
Power: 460 W

Only those products bearing the UL Listing Mark for the US and Canada should be
considered as being covered by UL's Listing and Follow-Up Service meeting the
appropriate requirements for US and Canada.

The UL Listing Mark for the US and Canada generally includes: the UL in a circle symbol
with "C" and "US" identifiers;  the word "LISTED"; a control number (may be
alphanumeric) assigned by UL; and the product category name (product identifier) as
indicated in the appropriate UL Directory.

Look for the UL Listing Mark on the product

Issued by: **Walter Hofmair**
Walter Hofmair, Senior Project Engineer
UL International Germany GmbH

Reviewed by: **Manfred Müller**
Manfred Müller, Senior Project Engineer
UL International Germany GmbH

Any information and documentation provided to you bearing UL Mark or logo are provided on behalf of Underwriters Laboratories Inc. UL International Germany GmbH

Certificate of Compliance

Certificate Number: 090806 - E215059
Report Reference: E215059, June 9th, 2006
Issue Date: 2006 August 9

Page 2 of 2



**Underwriters
Laboratories Inc.®**

This is to verify that representative samples of the product as specified on this certificate were tested according to the current UL, cUL requirements.

UL 61010-1 Electrical Equipment for Laboratory Use; Part 1: General Requirements
UL 61010A-1 Electrical Equipment for Laboratory Use; Part 1: General Requirements
UL 61010A-2-020 Electrical Equipment for Laboratory Use; Part 2: Particular Requirements for Laboratory Centrifuges
CSA C22.2 No. 1010.1 Electrical Equipment for Measurement, Control and Laboratory Use; Part 1: General Requirements
CSA C22.2 No.1010.2.020, CSA-C22.2 No. 1010.2.020A Electrical Equipment for Laboratory Use; Part 2: Particular Requirements for Laboratory Centrifuges

Issued by: **Walter Hofmair**
Walter Hofmair, Senior Project Engineer
UL International Germany GmbH
Any information and documentation provided to you involving UL Mark services are provided on behalf of Underwriters Laboratories Inc. UL International Germany GmbH.

Reviewed by: **Manfred Müller**
Manfred Müller, Senior Project Engineer
UL International Germany GmbH

Certificate of Compliance

Certificate Number 261107 - E215059
Report Reference E215059, October 31, 2007
Issue Date 2007 November 26

Page 1 of 2



**Underwriters
Laboratories Inc.®**

Issued to: **EPPENDORF A G**
BARKHAUSENWEG 1
D-22339 HAMBURG GERMANY

*This is to certify that
representative samples of* **Centrifuge**
Model 5430R, 5428

*Have been investigated by Underwriters Laboratories Inc.® (UL) or any authorized
licensee of UL in accordance with the Standard(s) indicated on this Certificate.*

Standard(s) for Safety: See Addendum for Standards

Additional Information: See Addendum for Ratings

Only those products bearing the UL Listing Mark for the US and Canada should be considered as being covered by UL's Listing and Follow-Up Service meeting the appropriate requirements for US and Canada.

The UL Listing Mark for the US and Canada generally includes: the UL in a circle symbol with "C" and "US" identifiers;  the word "LISTED"; a control number (may be alphanumeric) assigned by UL; and the product category name (product identifier) as indicated in the appropriate UL Directory.

Look for the UL Listing Mark on the product

Issued by *Kiya Ghamari*
Kiya Ghamari, Associate Project Engineer

UL International Germany GmbH

Any information and documentation provided to you involving UL Mark services are provided on behalf of Underwriters Laboratories Inc./UL International Germany GmbH

Reviewed by *Walter Hofmair*
Walter Hofmair, Senior Project Engineer

UL International Germany GmbH

Certificate of Compliance

Certificate Number 261107 - E215059
Report Reference E215059, October 31, 2007
Issue Date 2007 November 26

Page 2 of 2



This is to verify that representative samples of the product as specified on this certificate were tested according to the current UL, cUL requirements.

Standards:

UL 61010-1 - Electrical Equipment for Laboratory Use; Part 1: Second Edition; Part 2: Particular Requirements for Laboratory Centrifuges, IEC 61010-2-020, 2006.

CSA C22.2 No. 61010-1 - Electrical Equipment for Measurement, Control and Laboratory Use; Part 1: General Requirements Second Edition; Part 2: Particular Requirements for Laboratory Centrifuges, IEC 61010-2-020, 2006

ELECTRICAL RATING:

Voltage: 120 V ac

Frequency: 50-60 HZ

Current: 12 A

Power: 1050 W

MECH. RATING:

Max. Speed: 17 500 RPM

Kinetic energy: 10 000 Nm

Max. density of Liquid: 1.2 kg/dm³

Issued by: *Kiya Ghamari*
Kiya Ghamari, Associate Project Engineer

Reviewed by: *Walter Hofmair*
Walter Hofmair, Senior Project Engineer

UL International Germany GmbH

UL International Germany GmbH

Any information and documentation provided to you involving UL-Mark services are provided on behalf of Underwriters Laboratories Inc./UL International Germany GmbH

Centre of Emergency Preparedness and Response
Health Protection Agency
Porton Down
Salisbury
Wiltshire SP4 0JG
United Kingdom



Certificate of Containment Testing

Rotor FA 45-30-11 (5427 713.107-00)
with sealed lid in Eppendorf centrifuge
5430

Report No. 955-05

Report prepared for: Eppendorf AG, Hamburg, Germany
Issue Date: 2nd June 2005

Test Summary

The FA 45-30-11 rotor (5427 713.107-00) was containment tested in the Eppendorf centrifuge 5430, using Annex AA of IEC 1010-2-20. The rotor was shown to contain a large spill within the rotor.

Report Written By

A blue ink signature written over a horizontal dashed line.

Report Authorised By

A blue ink signature written over a horizontal dashed line.



Centre of Emergency Preparedness and Response
Health Protection Agency
Porton Down
Salisbury
Wiltshire SP4 0JG
United Kingdom

Certificate of Containment Testing

**Rotor FA 45-24-11-HS
(5427 710.108-01) with sealed lid in
Eppendorf centrifuge 5430**

Report No. 980-05 B

Report prepared for: Eppendorf AG, Hamburg, Germany
Issue Date: 8th November 2005

Test Summary

The FA 45-24-11-HS rotor (5427 710.108-01) was containment tested in the Eppendorf centrifuge 5430, using Annex AA of IEC 1010-2-20. The rotor was shown to contain a large spill within the rotor.

Report Written By

A blue ink signature written over a horizontal dashed line.

Report Authorised By

Two blue ink signatures written over a horizontal dashed line.

Centre of Emergency Preparedness and Response
Health Protection Agency
Porton Down
Salisbury
Wiltshire SP4 0JG
United Kingdom



Certificate of Containment Testing

Rotor FA 45-24-11-KIT (5427 703.101-00)
with sealed lid in Eppendorf centrifuge
5430

Report No. 956-05

Report prepared for: Eppendorf AG, Hamburg, Germany
Issue Date: 7th June 2005

Test Summary

The FA 45-24-11-KIT rotor (5427 703.101-00) was containment tested in the Eppendorf centrifuge 5430, using Annex AA of IEC 1010-2-20. The rotor was shown to contain a large spill within the rotor.

Report Written By

A blue ink signature written over a horizontal dashed line.

Report Authorised By

A blue ink signature written over a horizontal dashed line.



Certificate of Containment Testing

Containment Testing of Rotor FA-45-48-11 (5427 754.105-00) in the Eppendorf 5430/R Bench Top Centrifuge



Report No. 201-12 A

Report Prepared For: Eppendorf AG, Hamburg, Germany

Issue Date: 12th September 2012

Test Summary

Rotor FA-45-48-11 (5427 754.105-00) was containment tested in the Eppendorf 5430/R bench top centrifuge, using Annex AA of IEC 1010-2-20. The sealed rotor was shown to contain a spill within the centrifuge

Report Written By  Name: Miss Anna Moy Title: Biosafety Scientist	Report Authorised By  Name: Mrs Sara Speight Title: Senior Biosafety Scientist
--	---



Certificate of Containment Testing

Containment Testing of Rotor FA-45-30-11 (5427 753.109-00) in the Eppendorf 5430/R Bench Top Centrifuge

Report No. 201-12 B

Report Prepared For: Eppendorf AG, Hamburg, Germany

Issue Date: 12th September 2012

Test Summary

Rotor FA-45-30-11 (5427 753.109-00) was containment tested in the Eppendorf 5430/R bench top centrifuge, using Annex AA of IEC 1010-2-20. The sealed rotor was shown to contain a spill within the centrifuge

Report Written By

Handwritten signature of Anna Moy in cursive script.

Name: Miss Anna Moy
Title: Biosafety Scientist

Report Authorised By

Handwritten signature of Sara Speight in cursive script.

Name: Mrs Sara Speight
Title: Senior Biosafety Scientist



Certificate of Containment Testing

Containment Testing of Rotor FA-45-24-11-Kit (5427 752.102-00) in the Eppendorf 5430/R Bench Top Centrifuge



Report No. 201-12 D

Report Prepared For: Eppendorf AG, Hamburg, Germany

Issue Date: 12th September 2012

Test Summary

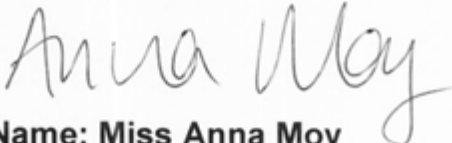
Rotor FA-45-24-11-Kit (5427 752.102-00) was containment tested in the Eppendorf 5430/R bench top centrifuge, using Annex AA of IEC 1010-2-20. The sealed rotor was shown to contain a spill within the centrifuge

Report Written By  Name: Miss Anna Moy Title: Biosafety Scientist	Report Authorised By  Name: Mrs Sara Speight Title: Senior Biosafety Scientist
--	---



Public Health
England

Public Health England
Microbiology Services
Porton Down
Salisbury
Wiltshire
SP4 OJG

Certificate of Containment Testing

Containment Testing of Rotor FA-45-16-17 (5427 750.100-00) in the Eppendorf 5430/R Bench Top Centrifuge

Report No. 39/13

Report Prepared For: Eppendorf AG, Hamburg, Germany
Issue Date: 24th April 2013

Test Summary

Rotor FA-45-16-17 (5427 750.100-00) was containment tested in the Eppendorf 5430/R bench top centrifuge, using Annex AA of IEC 61010-2-020:2006 (2nd Ed.). The sealed rotor was shown to contain a spill within the centrifuge.

Report Written By

Name: Miss Anna Moy
Title: Biosafety Scientist

Report Authorised By

Name: Mrs Sara Speight
Title: Senior Biosafety Scientist

Please be aware that the use of the Royal Coat of Arms is highly restricted and cannot be copied. Please do not put the PHE logo on your website or use our name to endorse your products. Any reference to PHE needs to be approved by us before it can be used.



Certificate of Containment Testing

Containment Testing of Rotor S-24-11-AT (5427 757.104-00) in the Eppendorf 5430/R Bench Top Centrifuge

Report No. 201-12 E

Report Prepared For: Eppendorf AG, Hamburg, Germany

Issue Date: 12th September 2012





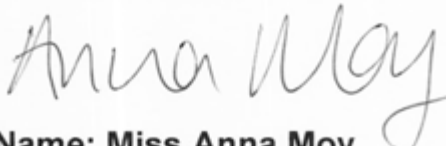
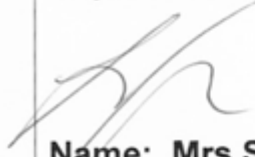

Test Summary

Rotor S-24-11-AT (5427 757.104-00) was containment tested in the Eppendorf 5430/R bench top centrifuge, using Annex AA of IEC 1010-2-20. The sealed rotor was shown to contain a spill within the centrifuge

Report Written By  Name: Miss Anna Moy Title: Biosafety Scientist	Report Authorised By  Name: Mrs Sara Speight Title: Senior Biosafety Scientist
--	--

Annex

Menu structure of Centrifuge 5430/5430 R

English	Deutsch	Français	Español	Display
Programs <ul style="list-style-type: none"> • Load program • Save program • Delete program 	Programme <ul style="list-style-type: none"> • Programm laden • Programm speichern • Programm löschen 	Programmes <ul style="list-style-type: none"> • Charger prog. • Enregistrer prog. • Supprimer prog. 	Programas <ul style="list-style-type: none"> • Cargar programa • Guardar programa • Borrar programa 	
Soft ramp <ul style="list-style-type: none"> • On • Off 	Softrampe <ul style="list-style-type: none"> • An • Aus 	Rampe douce <ul style="list-style-type: none"> • Marche • Arrêt 	Rampa suave <ul style="list-style-type: none"> • Encendido • Apagado 	SOFT
Key lock <ul style="list-style-type: none"> • On • Off 	Tastensperre <ul style="list-style-type: none"> • An • Aus 	Verrouilla. de touches <ul style="list-style-type: none"> • Marche • Arrêt 	Bloqueo del teclado <ul style="list-style-type: none"> • Encendido • Apagado 	 
At set rpm <ul style="list-style-type: none"> • On • Off 	At set rpm <ul style="list-style-type: none"> • An • Aus 	At set rpm <ul style="list-style-type: none"> • Marche • Arrêt 	At set rpm <ul style="list-style-type: none"> • Encendido • Apagado 	 
Short spin <ul style="list-style-type: none"> • Maximum speed • Current speed 	Short Spin <ul style="list-style-type: none"> • Maximaler Wert • Aktueller Wert 	Short Spin <ul style="list-style-type: none"> • Vitesse max • Vitesse actuelle 	Short Spin <ul style="list-style-type: none"> • Velocidad máximo • Velocidad actual 	
Continuous cooling (5430 R) <ul style="list-style-type: none"> • 8 h • ∞ 	Dauerkühlung (5430 R) <ul style="list-style-type: none"> • 8 h • ∞ 	Refrigération continue (5430 R) <ul style="list-style-type: none"> • 8 h • ∞ 	Refrigeración continua (5430 R) <ul style="list-style-type: none"> • 8 h • ∞ 	
Fast Temp pro (5430 R) <ul style="list-style-type: none"> • One-time-use • Repeated use 	Fast Temp pro (5430 R) <ul style="list-style-type: none"> • Einmal • Mehrmals 	Fast Temp pro (5430 R) <ul style="list-style-type: none"> • Une fois • Plusieurs fois 	Fast Temp pro (5430 R) <ul style="list-style-type: none"> • Una vez • Varias veces 	FTpro
Settings <ul style="list-style-type: none"> • Display <ul style="list-style-type: none"> – Standard display – Extended display • Alarm <ul style="list-style-type: none"> – On – Off • Volume <ul style="list-style-type: none"> – Cancel – Save – Default • Date/Time 	Einstellungen <ul style="list-style-type: none"> • Anzeige <ul style="list-style-type: none"> – Standardanzeige – Erweiterte Anzeige • Lautsprecher <ul style="list-style-type: none"> – An – Aus • Lautstärke <ul style="list-style-type: none"> – Abbrechen – Speichern – Lieferzustand • Datum/Uhrzeit 	Réglages <ul style="list-style-type: none"> • Affichage <ul style="list-style-type: none"> – Affichage standard – Affichage large • Signal sonore <ul style="list-style-type: none"> – Marche – Arrêt • Volume <ul style="list-style-type: none"> – Annuler – Enregistrer – Réglage usine • Date/Heure 	Ajustes <ul style="list-style-type: none"> • Indicador <ul style="list-style-type: none"> – Indicador estándar – Indicador extendido • Altavoz <ul style="list-style-type: none"> – Encendido – Apagado • Volumen <ul style="list-style-type: none"> – Cancelar – Guardar – Est. de Fábrica • Fecha/Hora 	 

English	Deutsch	Français	Español	Display
<ul style="list-style-type: none"> • Contrast <ul style="list-style-type: none"> – Cancel – Save – Default • Language <ul style="list-style-type: none"> – English – Deutsch – Français – Español • Standby <ul style="list-style-type: none"> – On – Off – Set time • Lid release (5430) <ul style="list-style-type: none"> – Automatic – Manual 	<ul style="list-style-type: none"> • Kontrast <ul style="list-style-type: none"> – Abbrechen – Speichern – Lieferzustand • Sprache <ul style="list-style-type: none"> – English – Deutsch – Français – Español • Standby <ul style="list-style-type: none"> – An – Aus – Zeit einstellen • Deckelöffnung (5430) <ul style="list-style-type: none"> – Automatisch – Manuell 	<ul style="list-style-type: none"> • Contraste <ul style="list-style-type: none"> – Annuler – Enregistrer – Réglage usine • Langue <ul style="list-style-type: none"> – English – Deutsch – Français – Español • Mise en veille <ul style="list-style-type: none"> – Marche – Arrêt – Réglage du temps • Ouverture couvercle (5430) <ul style="list-style-type: none"> – Automatique – Manuelle 	<ul style="list-style-type: none"> • Contraste <ul style="list-style-type: none"> – Cancelar – Guardar – Est. de Fábrica • Idioma <ul style="list-style-type: none"> – English – Deutsch – Français – Español • Standby <ul style="list-style-type: none"> – Encendido – Apagado – Establecer tiempo • Apertura de la tapa (5430) <ul style="list-style-type: none"> – Automática – Manual 	

Rotor F-35-6-30: Adapters for round-bottom tubes and blood taking systems

Adapter ⁽¹⁾	Bottom shape	Tube dimensions: Ø × length (min to max) ⁽²⁾	Rotor bore	r _{max}	Max. g-force (rcf)	Ordering No. (International)	Ordering No. (North America)
2.6 – 7 mL	round	13 × (65 to 89) mm	small	9.4 cm	6,443 × g	5427 740.007	5427740007
2.6 – 7 mL	round	13 × (65 to 89) mm	large	8.9 cm	6,100 × g	5427 742.000	5427742000
2.6 – 7 mL	round	13 × (90 to 110) mm	small	10.9 cm	7,471 × g	5427 741.003	5427741003
2.6 – 7 mL	round	13 × (90 to 110) mm	large	10.4 cm	7,129 × g	5427 743.006	5427743006
5 mL	conical	only 5 mL tubes	small	9.1 cm	6,237 × g	5427 746.005	5427746005
5 mL	conical	only 5 mL tubes	large	10.4 cm	7,129 × g	5427 747.001	5427747001
7 – 15 mL	round	16 × (74 to 103) mm	small	10.2 cm	7,005 × g	5427 732.004	022654512
7 – 15 mL	round	16 × (85 to 115) mm	large	10.2 cm	7,005 × g	5427 734.007	022654524
9 – 15 mL	round	16.8 × (84 to 125) mm	small	11.3 cm	7,745 × g	5427 735.003	022654538
9 – 15 mL	round	16.8 × (84 to 125) mm	large	10.8 cm	7,403 × g	5427 738.002	022654545
20 – 30 mL	round	26 × (97 to 110) mm	large	10.4 cm	7,087 × g	5427 736.000	022654556
50 mL	round	29 × (100 to 125) mm	large	11.1 cm	7,581 × g	5427 737.006	022654567

1) One tube per adapter, 6 per rotor. For the diameters 13, 16, and 16.8 mm, 12 tubes of the same type can be simultaneously centrifuged in 6 of each small and large adapters.

2) Min. tube length below cap rim to max. tube length incl. cap.

Evaluate your manual

Give us your feedback.
www.eppendorf.com/manualfeedback