

Grant bio

Densitometer
Suspension turbidity detector
DEN-1 & DEN-1B
Operating instructions



1.	About this edition of instructions	2
2.	Safety precautions.....	3
3.	General information	5
4.	Getting started.....	6
5.	Operation	7
6.	Calibration.....	8
7.	Specifications	9
8.	Guarantee and Service.....	10
9.	EU Declaration of conformity	11

1. About this edition of instructions

The current edition of the operating instructions applies to the following models and versions of densitometers, suspension turbidity detectors:

- **DEN-1** version V.2GW
- **DEN-1B** version V.2GW

2. Safety precautions



Caution!

Make sure you have fully read and understood the present instructions before using the equipment. Please pay special attention to sections marked by this symbol.

GENERAL SAFETY

- The protection provided can be ineffective if the operation of the appliance does not comply with the manufacturer's requirements.
- Save the unit from shocks and falling.
- Store and transport the unit at ambient temperatures between -20°C and +60°C and maximum relative humidity of 80%.
- After transportation or storage and before connecting it to the electric circuit, keep the unit under room temperature for 2-3 hrs.
- Use only original parts and accessories, provided by manufacturer for this product.
- Before using any cleaning or decontamination methods except those recommended by the manufacturer, check with the manufacturer that the proposed method will not damage the equipment.
- Do not make modifications in design of the unit.

ELECTRICAL SAFETY

- Connect only to the mains with voltage corresponding to that on the serial number label.
- Use only the external power supply provided with this product.
- Ensure that the power plug is easily accessible during use.
- Disconnect the unit from the mains before moving.
- If liquid penetrates into the unit, disconnect it from the mains and have it checked by a repair and maintenance technician.
- Do not operate the unit in premises where condensation can form. Operating conditions of the unit are defined in the **Specifications** section.

Batteries (only for model DEN-1B)



Warning!

Risk of fire and explosion!

- Use only AA size batteries, rechargeable or non-rechargeable.
- Replace all used batteries in the unit at the same time. Insert batteries properly, with the plus (+) and minus (-) terminals aligned correctly. In case of doubt, turn off the unit immediately and check the polarity.
- Keep all batteries in a safe place away from children and pets.
- Where possible, recycle the batteries. Contact local government for information about the disposal options in the area.
- Remove batteries from the unit if it will not be used for several months to avoid battery leakage.

- Do not mix old and new batteries, batteries of different brands, or batteries of different types (e.g. zinc chloride and alkaline batteries) in the same unit as this may cause the batteries to leak.
- Do not attempt to recharge non-rechargeable batteries. This can cause batteries to overheat or leak.
- Do not place batteries in a refrigerator. This will not 'recharge', increase storage life, or increase batteries' power.
- Do not exceed storage temperature, it reduces battery performance and may also lead to leakage.
- Do not remove the battery label, or attempt to take the battery apart, or dispose of in a fire as this may lead to rupture and/or chemical burns.

DURING OPERATION

- Do not operate the unit in environments with aggressive or explosive chemical mixtures. Please contact manufacturer for possible operation of the unit in specific atmospheres.
- Do not operate the unit if it is faulty or has been installed incorrectly.
- Do not use outside laboratory rooms.
- Use **Select** and **Install** buttons only for calibration of the unit. Pressing the buttons can cause loss of calibration.

BIOLOGICAL SAFETY

- It is the user's responsibility to carry out appropriate decontamination if hazardous material is spilt on or penetrates into the equipment.

3. General information

DEN-1 & DEN-1B densitometers are designed for solution turbidity measurement in the range of 0.3 - 5.0 McFarland units or 1×10^8 cells/ml - 15×10^8 cells/ml (**DEN-1B** - 0.0 - 6.0 McFarland units or 0 cells/ml - 18×10^8 cells/ml). **DEN-1 & DEN-1B** are capable of measuring solution turbidity in a wider range, up to 15.0 McFarland units, however, it is necessary to remember that in this case the measurement error values increase.

DEN-1 & DEN-1B densitometers are used as a sample preparation devices for 1) determining concentration of cells in the fermentation process, 2) detection of susceptibility of microorganisms against antibiotics, 3) identification of microorganisms with various test systems, 4) measuring optical density at fixed wavelength and 5) quantitative evaluation of concentration of dyed solutions that absorb green light.

The operation principle is based on optical density measurement with digital result representation in McFarland units.

The unit is calibrated at the factory and saves calibration data when being switched off. However, it can be recalibrated by multiple points in 0.5 - 5.0 McF range (for **DEN-1B**, 0.0 - 6.0 McF) if necessary. We recommend to use Grant standards to ensure full reliability, but it is acceptable to use other commercial as well as self prepared standards (e.g. BaSO_4).

Table 1. Interpretation of McFarland Standard results into corresponding numeric values of approximate bacterial suspension concentration and their optical density at 550 nm.

McFarland standard	Composition	Interpretation	
	Concentration of BaSO_4	Approximate bacterial concentration ¹	Theoretical optical density ² at 550 nm
0.5	2.40×10^{-5} mol/L	1.5×10^8 cells/ml	0.125
1	4.80×10^{-5} mol/L	3×10^8 cells/ml	0.25
2	9.60×10^{-5} mol/L	6×10^8 cells/ml	0.50
3	1.44×10^{-4} mol/L	9×10^8 cells/ml	0.75
4	1.92×10^{-4} mol/L	12×10^8 cells/ml	1.00
5	2.40×10^{-4} mol/L	15×10^8 cells/ml	1.25
6	2.88×10^{-4} mol/L	18×10^8 cells/ml	1.50

¹ Bacterial concentration depends on microorganism size. The numbers represent an average value valid for bacteria. For yeasts, which are larger in size, these numbers should be divided by about 30.

² Values correspond to optical densities of bacterial suspensions. The BaSO_4 solutions optical density values differ, because the particle size and form differ from those of bacteria and light is diffracted differently

4. Getting started

- 4.1. **Unpacking.** Remove packing materials carefully and retain them for future shipment or storage of the unit. Examine the unit carefully for any damage incurred during transit. The warranty does not cover in-transit damage. Warranty covers only the units transported in the original package.
- 4.2. **Complete set.** Package contents:
- 4.2.1. Standard set
- **DEN-1 / DEN-1B** Densitometer, suspension turbidity detector..... 1 pce.
 - **A-16** adapter for Ø16 mm tubes 1 pce.
 - AA batteries (for **DEN-1B** only)..... 3 pcs.
 - External power supply 1 pce.
 - Operating manual, declaration of conformity 1 copy
- 4.2.2. Optional accessories:
- **CKG16-4** calibration kit for Ø16 mm glass tubes on request
 - **CKG16-6** calibration kit for Ø16 mm glass tubes on request
 - **CKG18-4** calibration kit for Ø18 mm glass tubes on request
 - **CKG18-6** calibration kit for Ø18 mm glass tubes on request

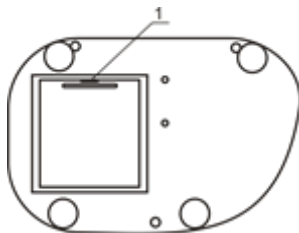

Figure 1.

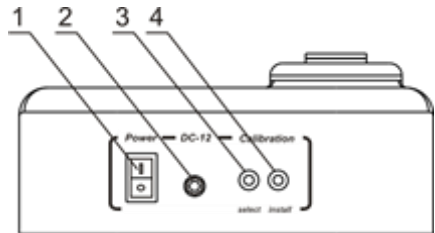

Figure 2.

- 4.3. **Setup.**
- (for **DEN-1B**) Battery installation. Insert a flat sharp pin in the small socket (fig. 1/1) on the underside and open the battery compartment. Insert batteries as shown on the scheme inside and close the compartment.
 - Place the unit on horizontal even working surface.
 - Plug the external power supply into the socket at the rear side of the unit.



Note. For **DEN-1B**, connecting external power supply is optional when the batteries are in use.

- Remove the protective film from the display.
- 4.4. **Factory calibration.** The device is pre-calibrated at the factory for operation with the glass tubes 16 mm in external diameter (see the label on the bottom side of the unit) at temperature range from +15°C to +25°C and saves calibration data when being switched off.



Attention! Recalibrate the unit before using the tubes that are different from factory calibrated (e.g. with different outer diameter, bottom shape or different material such as plastic). See the **Calibration** section of this manual.

5. Operation

Recommendations during operation

- Remove the tube with the solution from the socket before switching the unit on or off.
- We recommended keeping the unit switched on for 15 minutes before starting the operation in order to stabilize it in the working mode.
- If flat-bottomed tubes are used, the solution level should be higher than 7 mm from a tube bottom; if round-bottomed tubes are used - higher than 12 mm from a tube bottom.
- Check if the **A-16** adapter is in the socket (fig. 3/1). The device is calibrated for operation with the glass tubes 16 mm in external diameter. To use different tubes, recalibrate the unit, see the **Calibration** section of the manual.

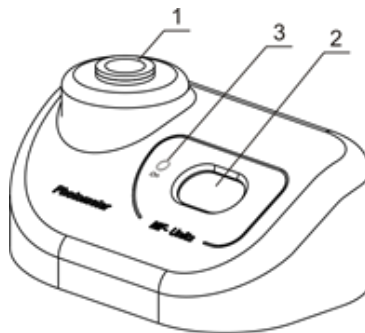

Figure 3. Front view

- 5.1. Connect the external power supply to electric circuit. Switch on the unit using the **Power** switch (fig. 2/1) on the rear panel.



Note. For **DEN-1B**, connecting external power supply is optional when the batteries are in use.

- 5.2. The following indication may be shown on the display (fig. 3/2):

- 0.0 (**DEN-1**) or 0.00 (**DEN-1B**) - the unit is calibrated and ready for operation.
- LO BAT (**DEN-1B**) - low batteries, replace the batteries as described in **4.3** or connect the external power supply.



Note. The display of **DEN-1B** switches off if the socket is empty for longer than one minute. Press the **On** key (fig. 3/3) to activate the unit.





- 5.3. Shake the tube with the solution. It is recommended to use a vortex for shaking, e.g. **Grant V-1 plus**. Insert the tube into the socket of densitometer (fig. 3/1). The McFarland value for the solution will be shown on the display (fig. 3/2).



Attention! Recalibrate the unit before using the tubes that are different from factory calibrated (e.g. with different outer diameter, bottom shape or different material such as plastic). See the **Calibration** section of this manual.

- 5.4. To ensure measurement precision, check that the external diameter of tubes is 16 mm (with **A-16** adapter) or 18 mm.
- 5.5. After finishing the operation switch OFF the unit using the **Power** switch (position **O**). If the external power supply is used, disconnect it from electric circuit.

6. Calibration

- 6.1. The device is pre-calibrated at the factory for operation with the glass tubes 16 mm in external diameter (see the label on the bottom side of the unit) at temperature range from +15°C to +25°C and saves calibration data when being switched off.
- 6.2. Before using the standards, prepare them according to instructions provided by the standard manufacturer.
- 6.3. Perform calibration from lower to higher calibration value. Use at least 2 points for calibration. Different calibration points are available:
- For **DEN-1**, calibration points are 0.5, 1.0, 2.0, 3.0, 4.0 and 5.0.
 - For **DEN-1B**, calibration points are 0.00, 0.50, 1.00, 2.00, 3.00, 4.00, 5.00 and 6.00.
- 6.4. Connect the external power supply to electric circuit. Switch on the unit using the **Power** switch (fig. 2/1) on the rear panel.
-  **Note.** For **DEN-1B**, connecting external power supply is optional when the batteries are in use.
-  **Attention!** Make sure that the tube socket is empty.
- 6.5. Press the **Select** button (fig. 2/3) on the rear of the unit.
-  **Note.** Use a thin pin of maximum diameter of 2 mm for pressing the **Select** and **Install** buttons.
- 6.6. To calibrate **DEN-1B** model, it is necessary to set values for an empty socket **---** and transparent standard **0.00**.
- 6.6.1. **Empty socket.** Display shows **---** indication. Press **Install** button (fig. 2/4) to save empty socket value. Display shows next required calibration value.
- 6.6.2. **Transparent standard.** Display shows **0.00** indication. Insert standard for **0.00** value into the socket (fig. 3/1) of the unit. If the standard for 0.00 value is not available, fill the tube (of the kind that is used for operations) with distilled water. Use the tube as the **0.00** value standard. Press **Install** button to save empty socket value. Display shows next required calibration value.
-  **Note!** Calibrate the unit using as many points as possible to obtain precise results. Minimum requirement are 2 points closest to the working range limits (e.g. 0.00 and 6.00 for operation in 0.00 - 6.00 McF range).
- 6.7. **Common calibration rules.** Display shows indication of necessary calibration value. Insert the necessary standard into the socket (fig. 3/1) of the unit and press the **Install** button to save the value for current standard.
-  **Note.** If pressing the **Install** button does not switch to the next standard value, it means that the current standard in the socket has lower turbidity value than the previous standard. Check or replace the standard.
- 6.8. If a standard is not available, press the **Select** button to skip to the next calibration value without recording the value.
- 6.9. Repeat steps **6.7-6.8** until the calibration is complete. After recording or skipping the last value, unit automatically exits calibration mode and is ready for operation.
- 6.10. **Reset to factory calibration.** To reset the calibration of the unit to factory settings, ensure that you are in the working mode and the socket of the unit is empty. Press and hold **Install** key for 5 seconds. The unit displays a dot **.**, then changes it to **0.0** or **0.00**. The values are now reset.
- 6.11. Switch off the unit using the Power switch (position **O**). If an external power supply is used, disconnect it from electric circuit.

7. Specifications

The unit is designed for operation in cold rooms, incubators (except CO₂ incubators) and closed laboratory rooms at ambient temperature from +4°C to +40°C in a non-condensing atmosphere and maximum relative humidity 80% for temperatures up to 31°C decreasing linearly to 50% relative humidity at 40°C.

Grant is committed to a continuous programme of improvement and reserves the right to alter design and specifications of the equipment without additional notice.

Parameter \ Model	DEN-1	DEN-1B
Light source	LED	
Wavelength	$\lambda = 565 \pm 15 \text{ nm}$	
McFarland unit range	0.3 - 15.0 McF	0.00 - 15.00 McF
Resolution	0.1 McF	0.01 McF
Factory calibration range	0.5 - 5.0 McF	0.00 - 6.00 McF
Accuracy in the factory calibration range	Full-scale error 3%	
Measurement time	1 s	
Sample volume	2 mL minimum	
External diameter of tube	16 mm (using A-16 adapter) or 18 mm	
Display	LED	LCD
Dimensions (L x W x H)	165 x 115 x 75 mm	
Weight ¹	0.7 kg	
Power consumption	1 W	0.1 W
Input current	12 V, 80 mA	12 V, 7 mA
External power supply	input AC 100-240 V, 50/60 Hz; output DC 12 V	
Batteries	-	3 x AA

Replacement parts	Description
A-16	Adapter for tubes of 16 mm in external diameter

Optional accessories	Description
CKG16-4	Calibration kit for glass tubes 16 mm in diameter. Polymer microparticle suspension. Set of 0.0, 0.5, 1.0, 2.0, 3.0, 4.0 McF turbidity standards
CKG16-6	Calibration kit for glass tubes 16 mm in diameter. Polymer microparticle suspension. Set of 0.0, 0.5, 1.0, 2.0, 3.0, 4.0, 5.0, 6.0 McF turbidity standards ²
CKG18-4	Calibration kit for glass tubes 18 mm in diameter. Polymer microparticle suspension. Set of 0.0, 0.5, 1.0, 2.0, 3.0, 4.0 McF turbidity standards
CKG18-6	Calibration kit for glass tubes 18 mm in diameter. Polymer microparticle suspension. Set of 0.0, 0.5, 1.0, 2.0, 3.0, 4.0, 5.0, 6.0 McF turbidity standards ²
Tubes	78 glass sample tubes, 16x100x0.8 mm. Factory standard

¹ Accurate within $\pm 10\%$

² For DEN-1, calibration is possible only up to 5.0 McF

8. Guarantee and Service

- 8.1. **Guarantee.** When used in laboratory conditions and according to these working instructions, this product is guaranteed for TWO YEARS (excluding items mentioned in the Optional Accessories table) against faulty materials or workmanship.
- 8.2. **Service.** There are no user-serviceable parts inside the unit. For all maintenance and repairs (except as defined below) return to our service department in the UK or in other countries, our distributor.
- 8.3. **Cleaning.** Standard ethanol (75%) or other cleaning agents recommended for cleaning of laboratory equipment can be used for cleaning and decontamination of the unit.

EU Declaration of Conformity

Unit type	Densitometers
Models	DEN-1, DEN-1B
Serial number	14 digits styled XXXXXXYYMMZZZZ, where XXXXXX is model code, YY and MM – year and month of production, ZZZZ – unit number.
Manufacturer	SIA BIOSAN Latvia, LV-1067, Riga, Ratsupites str. 7/2
Applicable Directives	EMC Directive 2014/30/EU LVD Directive 2014/35/EU RoHS2 2011/65/EU WEEE 2012/19/EU
Applicable Standards	<u>LVS EN 61326-1: 2013</u> Electrical equipment for measurement, control and laboratory use. EMC requirements. General requirements. <u>LVS EN 61010-1: 2011</u> Safety requirements for electrical equipment for measurement, control, and laboratory use. General requirements.

We declare that this product conforms to the requirements of the above Directives



Signature

Svetlana Bankovska
Managing director

19.07.2016.

Date



Signature

Aleksandr Shevchik
Engineer of R&D

19.07.2016

Date

Grant bio

**Grant Instruments
(Cambridge) Ltd**

Shepreth

Cambridgeshire

SG8 6GB

UK

Tel: +44 (0) 1763 260811

Fax: +44 (0) 1763 262410

Email: salesdesk@grantinstruments.com

www.grantinstruments.com

Densitometers, Suspension turbidity detectors / DEN-1 & DEN-1B / 2.03