

User Manual

Secura[®], Quintix[®], Practum[®]

Laboratory Balances

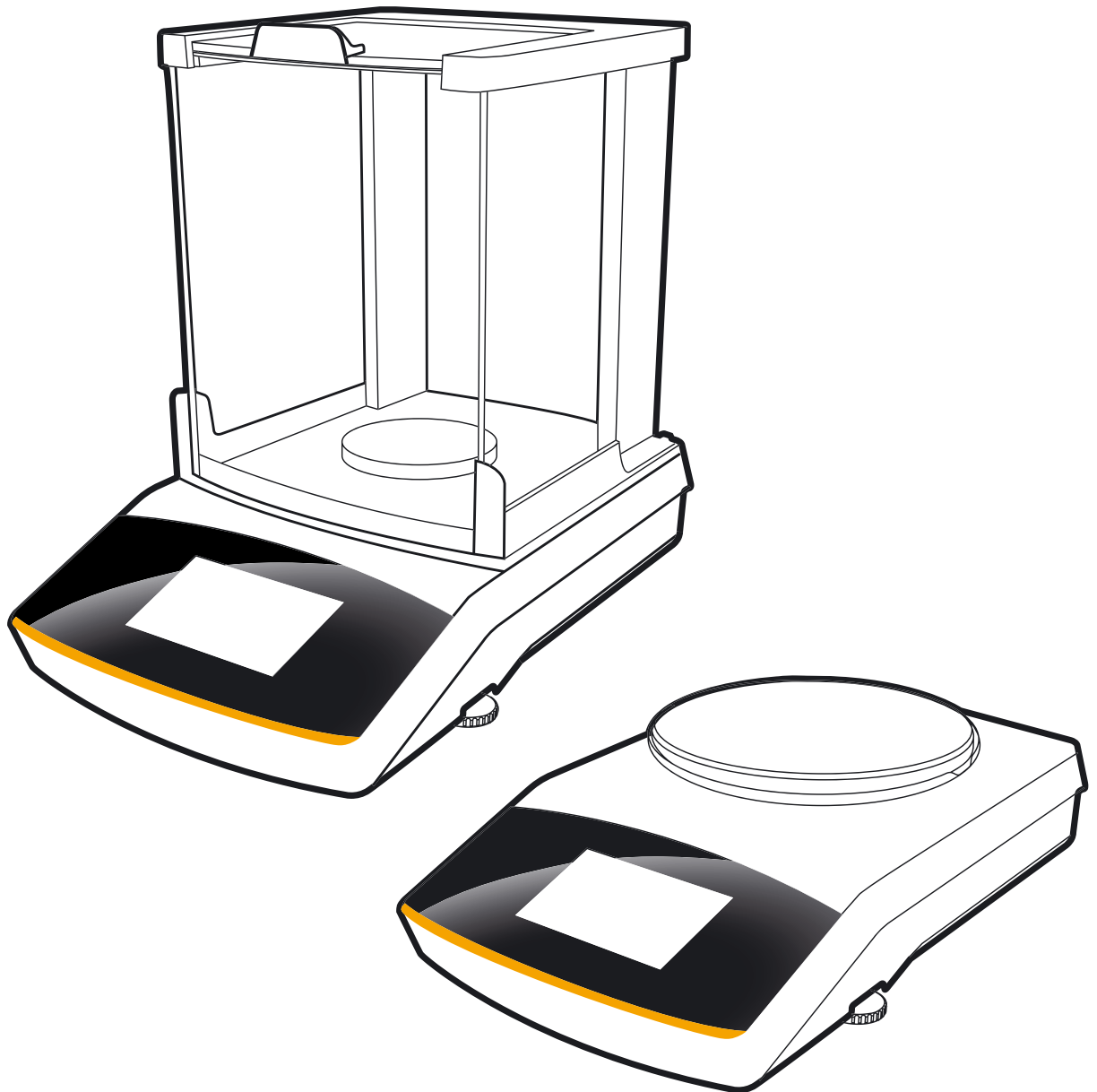

Contents

1. User Information	4
1.1 Warning/Danger Symbols.....	4
1.2 Symbols.....	4
1.3 Application Advice/Technical Support.....	5
2. Safety Information	6
2.1 Guidelines and General Information.....	6
2.2 Installation Information.....	6
2.3 Intended Use.....	7
3. General View of the Equipment	8
4. Getting Started	9
4.1 Unpacking and Equipment Supplied.....	9
4.2 Installing the Balance.....	10
4.3 Choosing a Location.....	12
4.4 Moving the Balance.....	13
4.5 Power Connection (Power Supply).....	14
4.6 Warm-up Time.....	15
4.7 Switching On the Balance.....	16
4.7.1 Startup Wizard.....	16
4.8 Below-balance Weighing.....	18
4.9 Anti-theft Locking Device.....	19
5. Using the Balance	20
5.1 Switching the Balance On/Off (Standby).....	20
5.2 Leveling.....	21
5.2.1 Leveling with Electronic Level Indicator (Secura®).....	21
5.2.2 Leveling with a Conventional Level Indicator (Quintix® and Practum®).....	22
5.3 Operating Concept.....	23
5.3.1 Operating and Display Elements on the Display.....	23
5.3.2 The Menu.....	24
5.3.3 Enter Figures on the Keypad.....	25
5.3.4 Text and Character Input (Secura® only).....	25
5.3.5 Accessing an Application in the Menu.....	26
5.3.6 List of Applications in the Menu.....	26
6. System Settings (Setup Menu)	28
6.1 Accessing the Menu and Changing Settings.....	28
6.2 List of Available Settings.....	29
6.2.1 Language.....	29
6.2.2 Date and Time (Secura® and Quintix® only).....	30
6.2.3 Device Information.....	31
6.2.4 Calibration/Adjustment.....	31
6.2.5 Weighing.....	31
6.2.6 Printout.....	34
6.2.7 Identifier (Secura® only).....	35
6.2.8 USB Port.....	36
6.2.9 Display Brightness.....	38
6.2.10 Acoustic signal.....	38
6.2.11 More Settings.....	39
7. Weighing	41
7.1 Mass Unit Conversion.....	42
7.2 SQmin Minimum Weighing (Secura® only).....	44
7.3 Individual Identifiers (Secura® only).....	45
7.4 Mixing (Secura® and Quintix® only).....	46
7.5 Statistics (Secura® and Quintix® only).....	49
7.6 Totalizing Components (Secura® and Quintix® only).....	52
7.7 Density.....	55
7.8 Percentage.....	59
7.9 Conversion (Secura® and Quintix® only).....	62
7.10 Unstable Condition.....	64
7.11 Checkweighing.....	66
7.12 Peak Hold.....	68
7.13 Counting.....	70
8. Calibration and Adjustment	73
8.1 Calibration/Adjustment Using an Internal Calibration Weight (Secura® and Quintix® only).....	74
8.2 Calibration/Adjustment Using an External Calibration Weight.....	75
8.3 Automatic Calibration/Adjustment with isoCAL.....	76
9. ISO/GLP-compliant Printout	77
9.3.1 Characteristics.....	77
9.3.2 Configuration.....	77
9.3.3 Operation.....	77
10.USB Port	79
10.1 Communication with Peripheral Devices.....	79
10.2 Direct Transfer of Data (PC).....	80
10.3 Interface Specification.....	86
10.3.1 Data Output.....	86
10.3.2 Data Output Formats.....	86
10.3.3 Data Output Format with 22 Characters.....	88
10.3.4 Data Input.....	89
10.3.5 Overview of Interface Commands (Commands).....	90
11.Status Messages	91
11.1 Key Fadeout.....	91
11.2 Error Messages in Applications.....	91
12.Transporting the Balance	93
13.Care and Maintenance	96
13.1 Service.....	96
13.2 Cleaning the Balance.....	96
14.Disposal	102
15.Specifications	103
15.1 General Data.....	103
15.2 Model-specific Data.....	105
15.3 Verified Models with Country-specific Type Approval Certificate.....	107
15.4 Accessories.....	110
15.5 Balance Dimensions.....	111
Appendix	116

1. User Information

1.1 Warning/Danger Symbols

Warning/danger symbols used in these instructions:



This symbol identifies hazards that have a high probability of resulting in death or serious physical injury if not avoided.



This symbol identifies hazards that can result in moderate or mild injuries if not avoided.



This symbol identifies hazards associated with the risk of material damage.

1.2 Symbols

The following symbols are used in this manual:



Useful information and tips



Notes for use in legal metrology



Note regarding device operation



When individual buttons are displayed, they should be pressed.

The following symbols are used in these instructions:

- ▶ Indicates a required action
- ▷ Describes what happens after you have performed a particular step

Perform steps in the specified order:

1. First action
 2. Second action
 3. ...
- Indicates an item in a list

Conventions for this user manual:

- The figures in this manual are based on "standard" balances. Some displays and printouts shown in the figures may differ from those of verified balances. The differences are explained in detail where they affect the operation of the balances.

1.3 Application Advice/Technical Support

Contact addresses for application advice and technical support can be found online at <http://www.sartorius.com>

2. Safety Information

2.1 Guidelines and General Information

- The balance complies with EU Directives and standards for electrical safety and electromagnetic compatibility.* Improper use or handling can, however, result in damage and/or injury. Any improper use or operation of the balance, i.e., that is not consistent with the instructions, will result in forfeiture of all claims under the manufacturer's warranty.
 - Personnel need to have read and understood these installation instructions, including the safety instructions.
 - In the event of use in systems and ambient conditions which have greater safety requirements, you must observe the requirements and provisions applicable in your country.
 - Always keep the equipment and balance freely accessible.
Any installation work or balance usage that does not conform to the instructions in this manual results in forfeiture of all claims under the manufacturer's warranty.
- * = See "Specifications."



Danger of explosion!

Do not use this equipment in hazardous areas in which explosive materials are present.



Make sure that the voltage rating printed on the AC adaptor is identical to your local mains voltage.

2.2 Installation Information



Do not operate the balance if its housing or AC adaptor including any of the connections are damaged. Immediately disconnect the damaged equipment from the power by pulling the plug to turn off the power.



Do not expose the balance and the accessories supplied by Sartorius to extreme temperatures, aggressive chemical vapors, moisture, shocks, vibration, or strong electromagnetic fields. Observe the conditions of operation described in the Specifications!



Installation note:

The operator shall be solely responsible for any modifications to the equipment and for connecting any cables or equipment not supplied by Sartorius. Information on operational quality is available upon request from Sartorius. Only use original Sartorius accessories.

Do not compromise the IP protection of the balance or of the AC adaptor. Do not allow liquid penetration. The protection class indicates the suitability of devices for different ambient conditions (humidity, foreign bodies).



Before cleaning the AC adaptor or balance, unplug the AC adaptor.

The balance may only be opened by specialized personnel trained by Sartorius. Do not open the AC adaptor.

Hazards during Installation and Operation



If glass breaks, there is a risk of injury posed by cuts on glass edges.



Lay the cables where they pose no risk of causing someone to trip.

Observe the additional safety and danger information in the following chapters.

2.3 Intended Use

This high-resolution balance is designed and intended for use only in laboratories and indoor areas under normal atmospheric conditions. It was developed specifically for the exact determination of the mass of materials in liquid, paste, powder, or solid form.

Appropriate containers must be used for each type of sample material.

3. General View of the Equipment

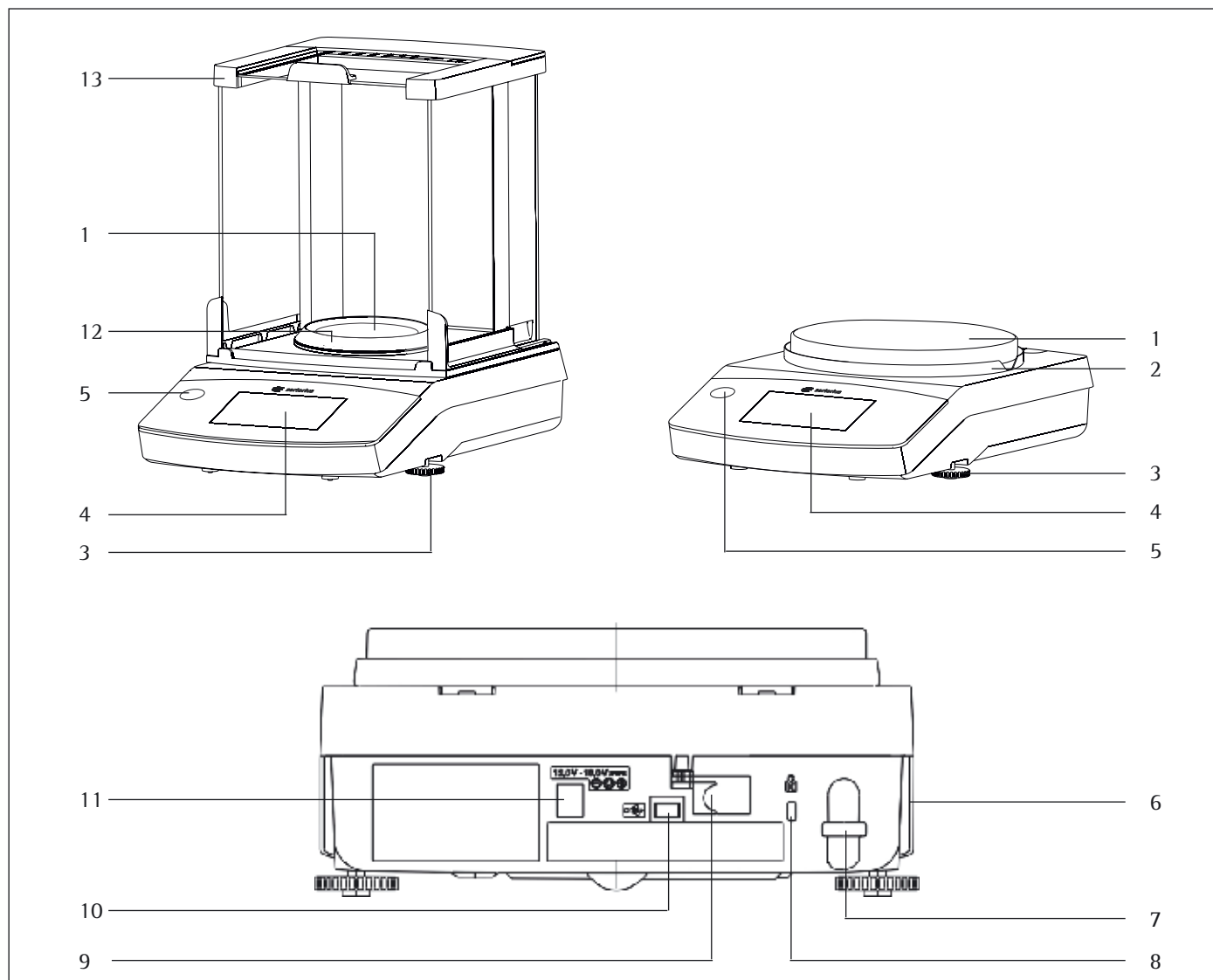

Pos. Name and Function

1	Weighing pan
2	Shield disk
3	Leveling feet
4	Touch screen
5	Level indicator (Quintix® and Practum® models)
6	Manufacturer's ID label and additional plate for verified models
7	Lug for attaching anti-theft locking device

Pos. Name and Function

8	Fastening point for an optional "Kensington" key lock
9	Menu access switch: locks various functions and units when balances are verified
10	USB port for mini AB
11	DC jack
12	Secura® models with readability of 0.1 mg: Pan draft shield
13	Draft shield

4. Getting Started

IMPORTANT

The balance must be disconnected from the mains power for all assembly work.

4.1 Unpacking and Equipment Supplied

- ▶ Open the packaging, making sure to remove all parts carefully.
- ▶ After unpacking the device, check it immediately for any external damage.
- ▷ If you detect any damage, proceed as directed in the chapter entitled "Care and maintenance."
- ▷ Save the box and all parts of the packaging for any future transport. During shipment, please do not leave cables plugged in!

The following parts are included in the equipment supplied:

Components	Balance with Draft Shield			Precision Balances
	0.1 mg	1 mg	10 mg, 0.1 g, and 1 g	
Readability:	0.1 mg	1 mg	10 mg, 0.1 g, and 1 g	
Draft shield	✓	✓	–	
Weighing pan: Ø 90 mm	✓	–	–	
Weighing pan: Ø 120 mm	–	✓	–	
Weighing pan: Ø 180 mm	–	–	✓	
Pan support	✓	✓	✓	
Shield disk (precision balances)	–	–	✓	
Pan draft shield (Secura® only)	✓	–	–	
AC adaptor with country-specific power plug	✓	✓	✓	
In-use dust cover	✓	✓	✓	
Dust cover	✓	✓	–	
Installation and operating instructions	✓	✓	✓	
Application guide	✓	✓	✓	

4.2 Installing the Balance

Secura® Models:

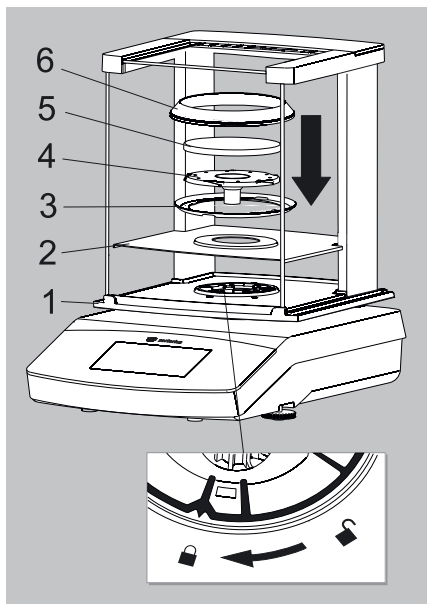

Balance with Draft Shield

► Install the following parts in the order listed:

- In-use dust cover
- Turn the draft shield lock to "unlocked" .
- Put the draft shield (1) on the balance.

Note:

Use both hands to hold the top struts of the draft shield.

Move the side doors right to the back.

- Turn the draft shield lock to "locked" .
- Put the shield plate (2), shield disk (3), pan support (4), weighing pan (5) and pan draft shield* (6) on the balance.

Note:

For information about how to clean the draft shield, see the Care and Maintenance chapter.

Quintix® and Practum® Models:

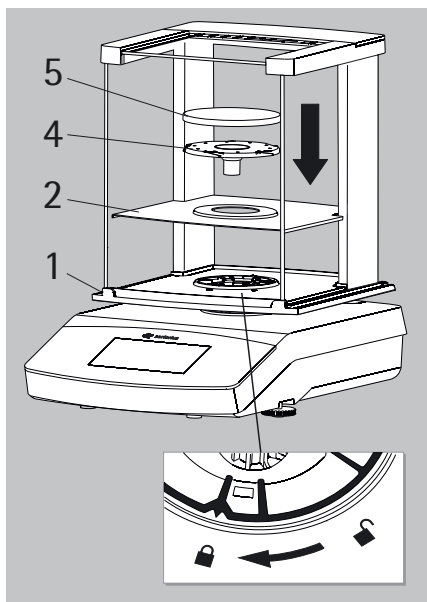

* = for models with readability of 0.1 mg only

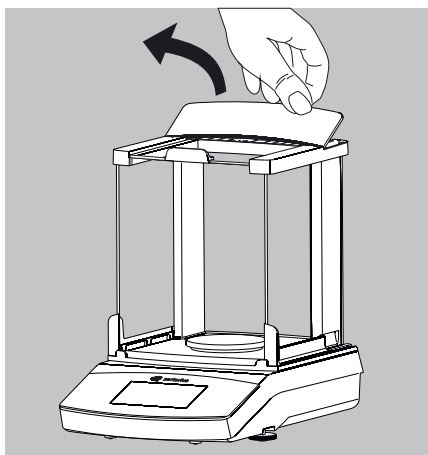

Inserting (or Removing) Glass Panels

1) Holding it by its rear edge, pull the draft shield cover up and remove it.

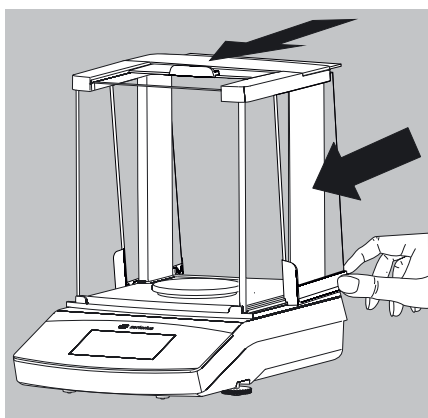

2) Push the three glass panels into the draft shield guide, all the way to the front.

3) Then replace the draft shield cover. In doing so, the draft shield cover must lock into position.

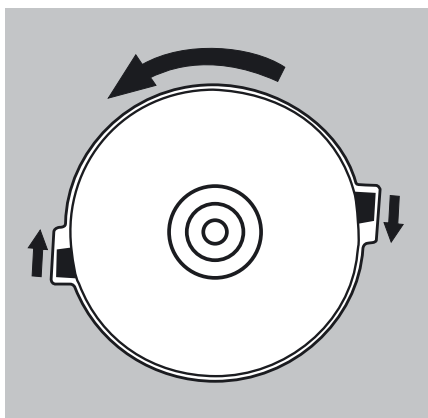

Balance with No Draft Shield

► Install the following parts in the given order:

1) In-use dust cover (not shown)

2) Install the shield disk (1) and turn this counterclockwise until securely in place.

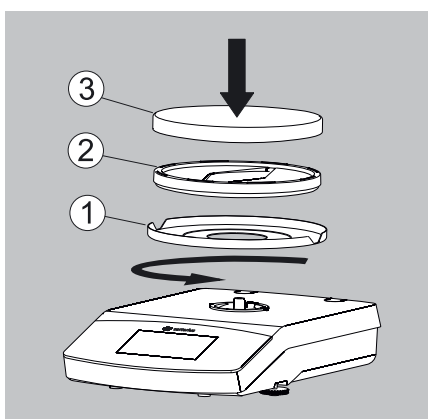

3) Install the pan support (1) and weighing pan (2).

4.3 Choosing a Location

► **Select the right setup location:**

- Set up the device on a stable, even surface that is not exposed to vibrations (e.g., weighing stone).
- Maintain free access to the device at all times.

Choose a location that is not subject to the following negative influences:

- Heat (heater or direct sunlight)
- Drafts from open windows, AC systems, and doors
- Vibrations during weighing
- Heavy traffic areas (personnel)
- Excessive moisture
- Electromagnetic fields

Acclimatization

Condensation from humidity can form on the surfaces of a cold device when it is brought into a warmer area. To avoid the effects of condensation, condition the balance for about two hours, leaving it unplugged from the power supply, before plugging the balance back into the mains.

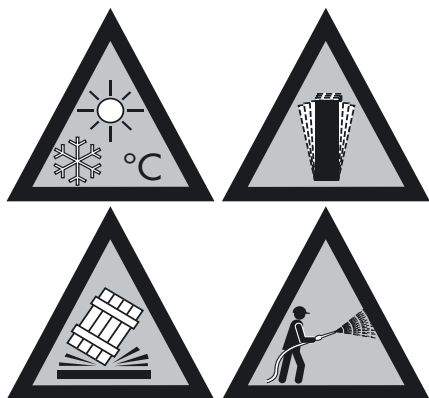

4.4 Moving the Balance

Moving the Balance over Short Distances in the Lab



Avoid glass breakage, shocks, and vibrations:
Never lift or carry the balance when holding it by its draft shield!

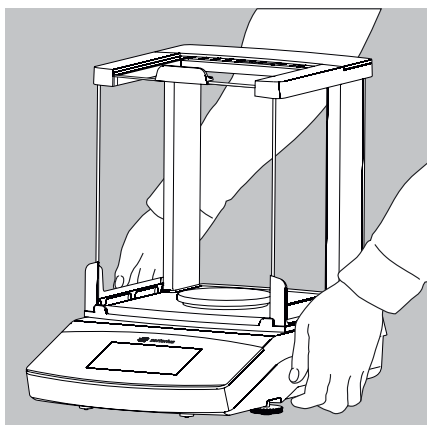
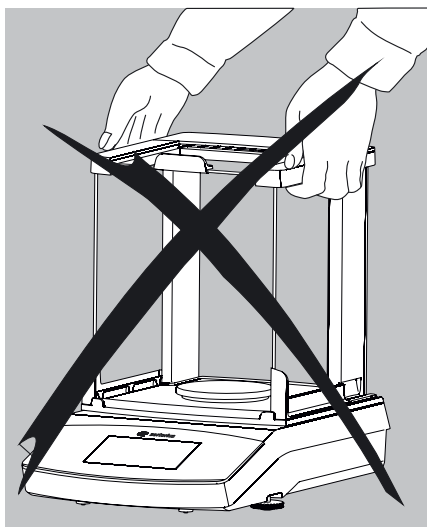

- ▶ Hold the balance under the housing, lift it up carefully, and carry it to its new location.



The balance needs to be re-leveled and calibrated each time its setup location is changed.

4.5 Power Connection (Power Supply)

AC Adaptor Assembly



Using the wrong power plug adaptors may cause fatal electric shock and damage the equipment. Never insert the power plug adaptor separately from the AC adaptor in the socket (danger of electric shock).

- ▶ Use the right power plug adaptor for your mains power supply.

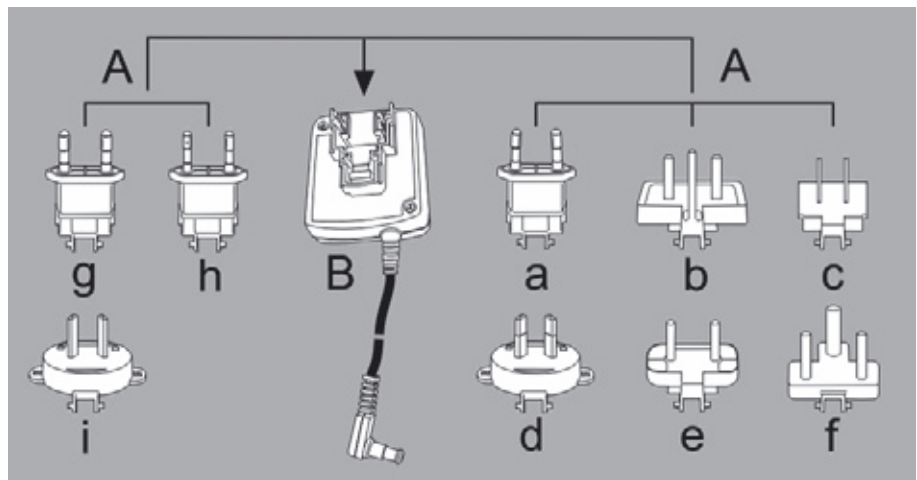

A AC adaptor versions:

Bag	Region/Country	Bag	Region/Country
a) transparent	Europe/EU (except UK)	e) black	India
b) yellow	United Kingdom	f) turquoise	South Africa
c) blue	USA, Canada, China and Japan	g) green	Korea
d) red	Australia	h) pink	Brazil
		i) white	Argentina

The packaging of AC adaptor module 6971790 with line adaptors g), h), and i) is labeled with 98671791.

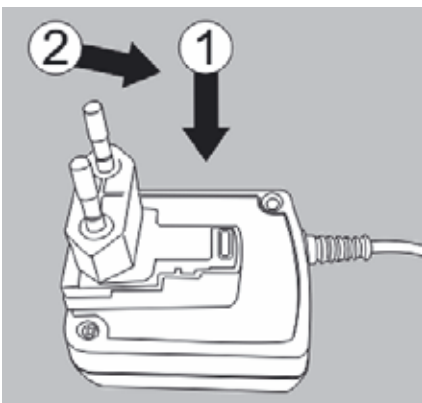

- ▶ Push (1) and slide (2) the power plug adaptor (A) required for the power supply into the opening of the AC adaptor module (B). When doing this, the AC adaptor needs to lock into position.

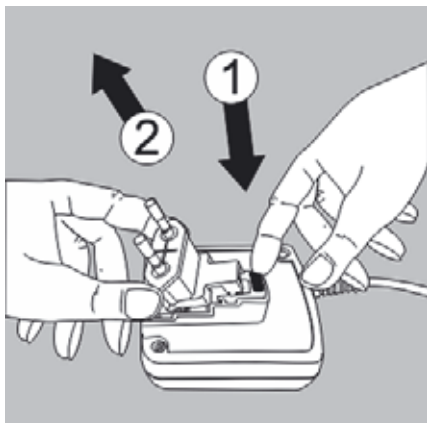

Removing/Replacing the AC Adaptor

- ▶ Unlock (1) the AC adaptor and then detach (2) it.

Power Connection/Safety Precautions

- Only use original Sartorius AC adaptors. The AC adaptor has an IP rating of IP40 in accordance with EN 60529.
- Make sure that the voltage rating printed on the manufacturer's ID label is identical to that of your local mains voltage.
- If the stated supply voltage or the plug design of the AC adaptor does not comply with your country's standard, please inform the nearest Sartorius representative.
- The power must be connected in accordance with the regulations applicable in your country.

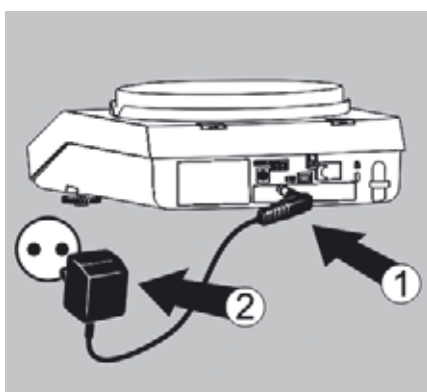

- ▶ 1) First of all, plug the AC adaptor into the socket at the back of your balance.
- ▶ 2) Afterwards, plug the AC adaptor into an electrical outlet (mains power supply).

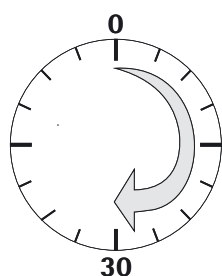

4.6 Warm-up Time

- ▶ To ensure accurate results are delivered, the balance must warm up for at least 30 minutes after initial connection to the power supply. Only after this time will the device have reached the required operating temperature.

M

When a verified balance of accuracy class I for use in legal metrology is connected to the mains power, it must warm up for at least one hour before operation.

4.7 Switching On the Balance



- ▶ Touch  on the display to switch on the balance.
- ▶ When the balance is switched on for the first time or when it has been reset to the factory settings, the startup wizard appears.

4.7.1 Startup Wizard

(software version "APC: 01-70-03.00" or later)

The default language for the display text is English. When the balance is switched on for the first time, the startup wizard is activated automatically. Follow the instructions on the interactive display to configure your selections for:

- Language
- Date format/date
- Time format/time

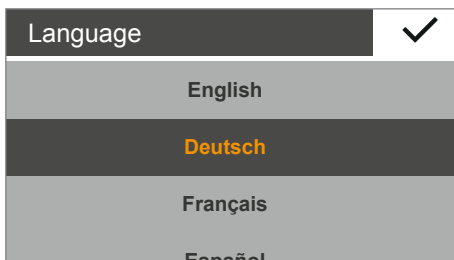

- ▶ The **Language** settings window appears.
- ▶ Touch the language you would like to select, such as **Deutsch**.
- ▶ Touch  to confirm.
- ▶ The display changes immediately to the desired language.

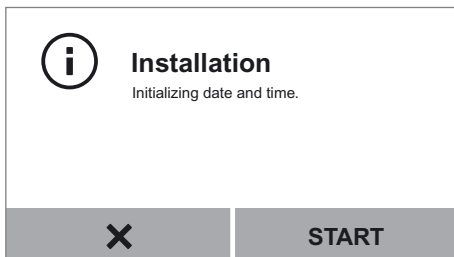

- ▶ The **Installation** settings window appears.
- The display format, date, and time can be set here.
- ▶ Touch **START**.

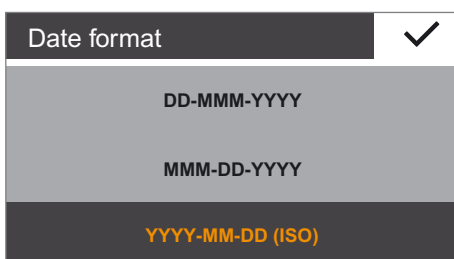

- ▶ The **Date Format** settings window appears:
- ▶ Select how the date should be displayed and printed out.
 - **DD-MMM-YYYY:**
The date is displayed in the order of day, month and then year.
 - **MMM-DD-YYYY:**
The date is displayed in the order of month, day and then year.
 - **YYYY-MM-DD (ISO):**
The date is displayed in the order of year, month and then day.
(The time is displayed in 24-hour format with this setting.)
- ▶ Touch  to confirm.

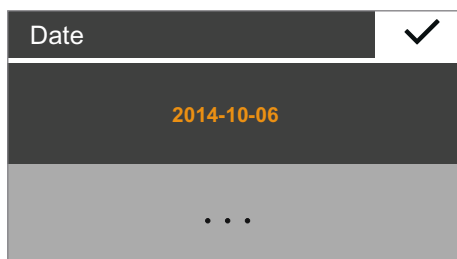

- ▷ The current date is displayed.
- ▶ If the date is displayed correctly, select ✓ to confirm.
- ▶ To adjust the date manually, if required, touch ..., enter the current date and confirm with ✓.

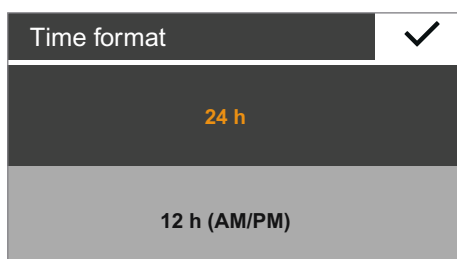

- ▷ The **Time format** settings window appears:
- ▶ Select how the time is displayed and printed out.
 - **24h:**
The time is displayed in 24-hour format. (This is the only available setting when the date is set to ISO format.)
 - **12h (AM/PM)**
The time is displayed in 12-hour format. The hours before noon are displayed with **AM**, and the hours after noon are displayed with **PM**.
- ▶ Touch ✓ to confirm.

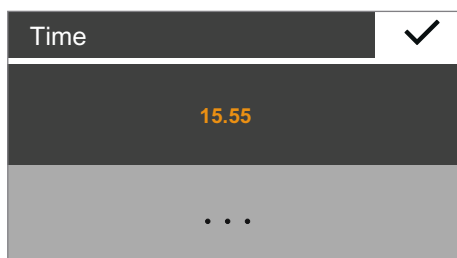

- ▷ The current time is displayed.
- ▶ If the time is displayed correctly, touch ✓ to confirm.
- ▶ To adjust the time manually, if required, touch ..., enter the current time and confirm with ✓.

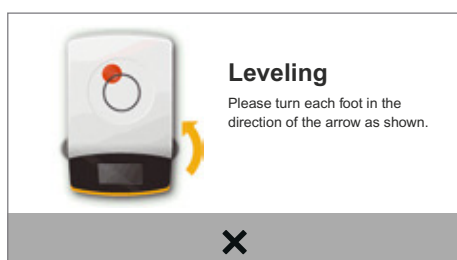

- ▷ The **Leveling** settings window appears:
 - ▶ Follow the instructions on the interactive display.
- Follow the instructions in Chapter "Leveling", page 21.



If required, you can subsequently modify your selection in the "Settings" menu (see Chapter "Accessing the Menu and Changing Settings", page 28).

4.8 Below-balance Weighing

A port for a below-balance weighing hook is located on the bottom of the balance.



Install a draft protection shield.

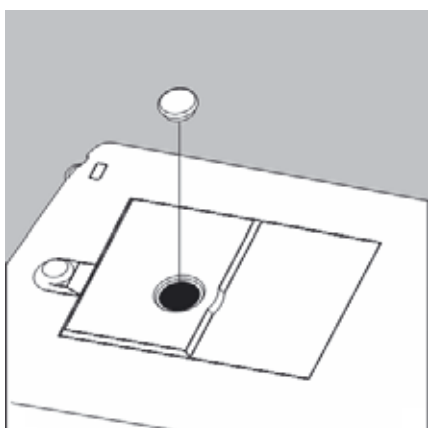

► Lift cover plate out of the bottom of the balance.



When doing this, put the balance to one side and not on the weighing pan side. Placing the balance on the weighing pan side may lead to measurement inaccuracies and damage to the balance!

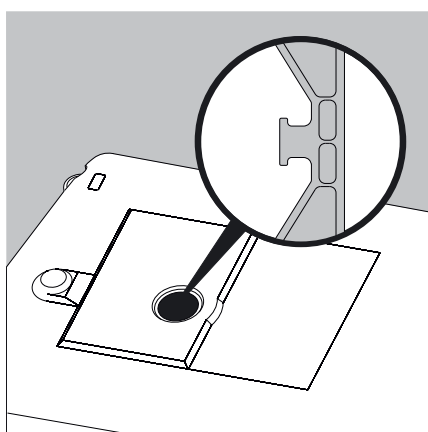

► Attach a wire (or similar) to the sample and hang it on the notched hook.



If the below-balance weighing port is no longer being used, close the opening with the cover plate again, so that the weighing results are not adversely affected by drafts.



The below-balance weighing port may not be opened or used on balances used for legal metrology.

4.9 Anti-theft Locking Device

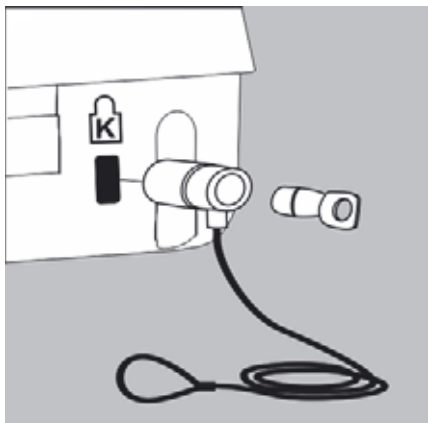

- ▶ A "Kensington" key lock cable can be installed at the fastening point on the back of the balance if required.

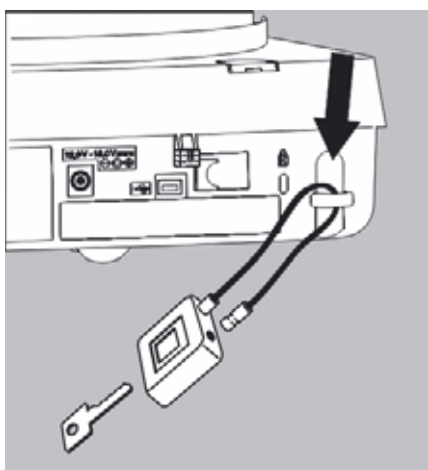

- ▶ The balance can also be secured in place at the installation location with a chain or lock, for example.

5. Using the Balance

5.1 Switching the Balance On/Off (Standby)

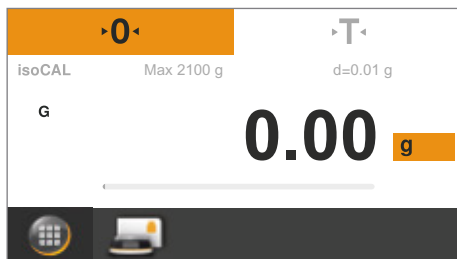

- ▷ The Leveling screen is displayed first after any model is switched on. Level the balance if necessary. The actual weighing screen is only displayed after confirmation.
- When the balance is switched on, the following message appears on the display:
 - Secura®: **Level** The balance has been leveled (if leveled).
 - Quintix® and Practum®: **Level** Please check leveling.
- If the balance needs to be leveled, a corresponding message appears on the display (see page 21).
- The balance must be regularly calibrated and adjusted to ensure correct weighing results (see page 73).
- The display text is given in English as a default. The language can be changed (see page 29).



- ▶ To switch the balance to standby mode, select the Menu key at the bottom left of the display on the Weighing screen.

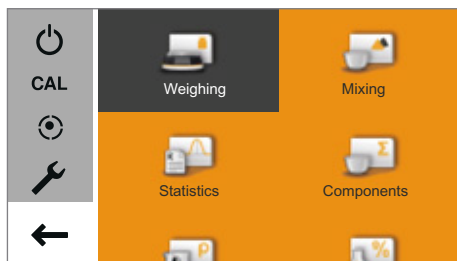

- ▷ The menu is displayed.



- ▶ Select the  button in the Application menu.
- ▷ The balance switches to standby mode.



- ▶ To switch the balance back on, select  on the display. The balance starts in the application that was most recently used before it was switched off.

5.2 Leveling

The balance must be level to ensure precise weighing results. Leveling the balance compensates for slant or unevenness at the place of installation by twisting the front leveling feet of the balance.

The balance needs to be re-leveled and adjusted each time its setup location is changed.

The leveling function is different for the various balance models:

- Electronic level indicator (Secura® only)
- Conventional level indicator (Quintix® and Practum®)



Note: The balance needs to be re-leveled and then adjusted each time its location is changed.

5.2.1 Leveling with Electronic Level Indicator (Secura®)

In Secura® models, the balance's position is checked with sensors. Instructions on the display guide the user when leveling the balance.

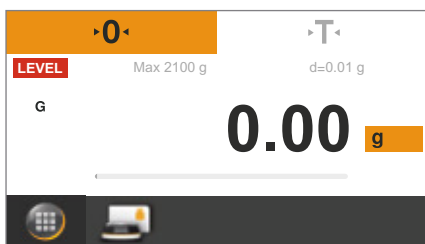

- ▶ When **LEVEL** appears in red at the top left of the display, you must level the balance.

LEVEL

- ▶ To start the leveling function, select the **LEVEL** button.

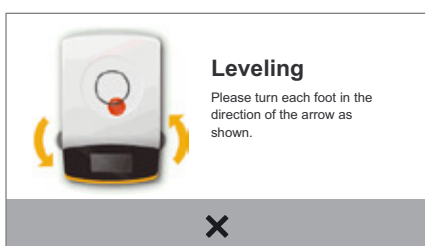

- ▶ The balance position is shown as an animation of a level indicator on the display.
- ▶ Twist the front leveling feet of the balance in the specified direction.



A prompt appears every 2 minutes after confirmation of this "Leveling" status message if the balance has not been leveled.

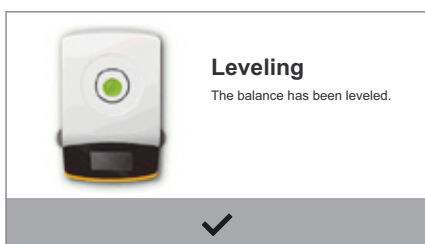

- ▶ When the level indicator animation turns green, the balance is correctly leveled.
- ▶ To exit the function, select ✓.
- ▶ Complete the leveling by calibrating the balance.

5.2.2 Leveling with a Conventional Level Indicator (Quintix® and Practum®)

The Quintix® and Practum® models are fitted with a conventional level indicator. This is located to the left of the display. The position of the air bubble in the indicator shows whether or not the balance is correctly leveled.

- ▶ Twist both of the front leveling feet of the balance to move the air bubble so that it is centered in the circular marking.

The figure shows which leveling foot should be twisted in which direction. Generally, both feet must be adjusted in order to position the air bubble exactly in the center of the circular marking.

Examples:

- If the air bubble is too far to the lower right, twist the right leveling foot counterclockwise (see figure).
- If the air bubble is too far to the upper right, twist the left leveling foot clockwise.
- If the air bubble is too far to the left, twist the left leveling foot counterclockwise and the right leveling foot clockwise.

- ▶ Check the level indicator after each adjustment and correct if necessary.
- ▶ Complete the leveling by calibrating the balance.

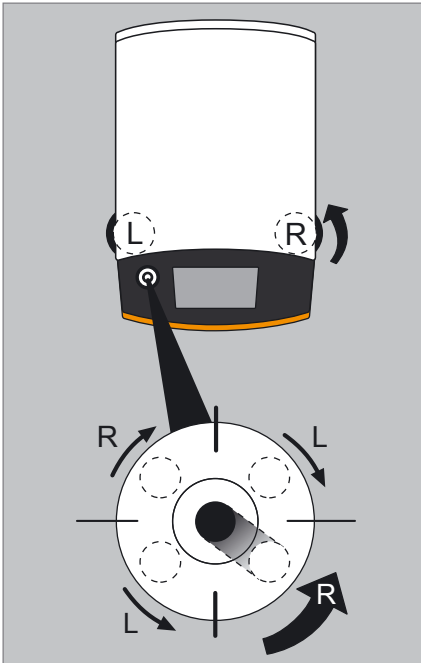

5.3 Operating Concept

This section describes the operational possibilities of your balance.

5.3.1 Operating and Display Elements on the Display



Sharp or pointed instruments (such as ballpoint pens) **can damage the device.**

- The touch screen should only be operated by lightly touching it with your fingertips.

This can be done while wearing laboratory gloves.

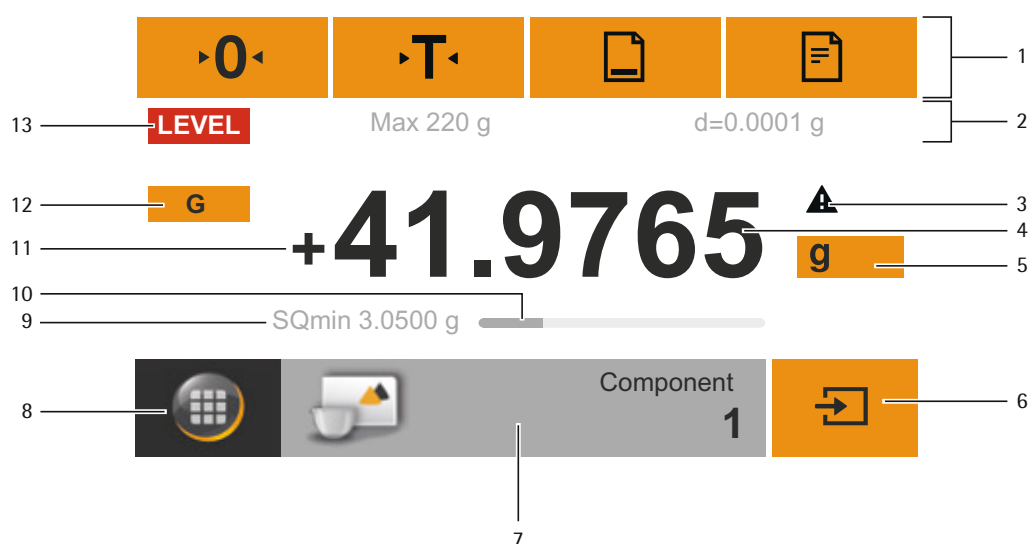

- 1 Toolbar with currently available buttons:
Zero, Tare, and possibly Print (data output) and GLP printout
- 2 Metrology line (additional info for minimum capacity Min and the verification scale interval e appear on verified balances)
- 3 Warning symbol for calculated values, negative gross values, or values that are smaller than the minimum initial weight (SQmin)
- 4 Current measurement value
- 5 Unit and stability indicator; set weight unit and display accuracy (see page 42)
- 6 Run application, such as saving the weight value of a component
- 7 Settings for the selected application
- 8 Menu key: switch to menu and functional selection
- 9 SQmin minimum weighing (Secura® only; see page 44)
- 10 Bar graph: scaled measurement value display (percentage weighing capacity)
- 11 Preceding symbol (\pm) for weight value
- 12 Display value ID, e.g. "G" for gross value, "Net" for net value; switch display value for application, such as net value, total value, weight value, or calculated value
- 13 Field for status and warning displays, and activation of isoCAL and leveling

5.3.2 The Menu

All balance application and settings can be accessed via the balance menu.



▶ To access the menu, select the Menu key located at the bottom left of the display in any application.

▷ The menu appears.



- 1 Selected application (such as **Mixing**)
- 2 Application selection area: symbols for all available applications (see "List of Applications in the Menu" on page 26)
- 3 Function area
- 4 Back: run the most recent application.
- 5 Setup menu: access the balance system settings (see "System Settings (Setup Menu)" on page 28).
- 6 Access the balance leveling function via electronic level indicator (Secura® only) (see "Leveling with Electronic Level Indicator (Secura®)" on page 21).
- 7 Access the calibration and adjustment options (see "Calibration and Adjustment" on page 73).
- 8 Switch the balance to standby mode.

Min			+ 0000000 g	✓
1	2	3	←	C
4	5	6		
7	8	9	←	C
+/-	0	.		

5.3.3 Enter Figures on the Keypad

Numerical values can be entered for many applications or system settings (such as a minimum value for the **Checkweighing** application). A keypad appears on the display, which can be used for this purpose.

- ▶ To enter numbers or values, touch the corresponding numbers in order. The entered numbers appear at the top of the display.
- ▶ To correct the most recent number, select ←. The number is deleted. Then enter the correct number.
- ▶ To delete the entire value, select C.
- ▶ To confirm the entry, select ✓.

Sample												✓
q	w	e	r	t	y	u	i	o	p			
a	s	d	f	g	h	j	k	l	/			
↑	z	x	c	v	b	n	m	-	:			
123	↵										←	

5.3.4 Text and Character Input (Secura® only)

A keyboard will appear whenever you have to enter text or characters. The cursor is located in the line above the keyboard.

- ▶ Select the desired character simply by touching them.
- ▶ The entered text will appear in the input line.
- ▶ Press the shift button to change between uppercase and lowercase letters.
- ▶ Press the 123 key to switch from letters to numbers.
- ▶ Press the ABC key to switch from numbers to letters.
- ▶ The backspace key is used to delete the character to the right.
- ▶ The ✓ key ends the process and saves the characters entered.



5.3.5 Accessing an Application in the Menu

The right-hand side of the display shows available applications for various weighing tasks which can be carried out with the balance.

You can scroll up and down through the menu to select the desired application.

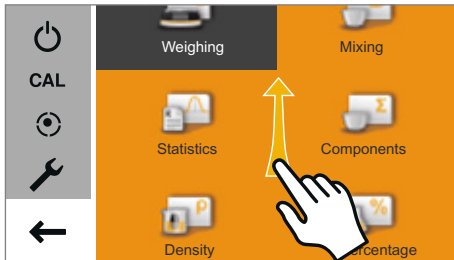

- ▶ To scroll through the menu, place a finger on the display and drag it slowly up or down.
- ▷ The symbols in the menu move in the corresponding direction.

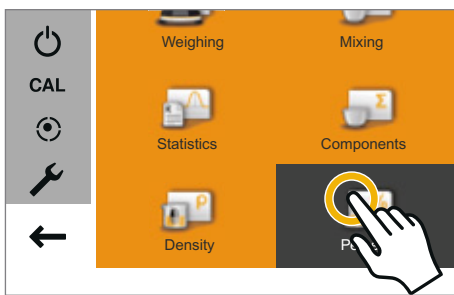

- ▶ Select a symbol to start that particular application.

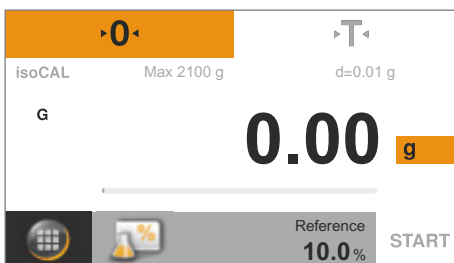

- ▷ The desired application appears on the display.

5.3.6 List of Applications in the Menu

The menu provides the following applications for various weighing tasks:



Weighing (see page 41)

This is the standard application that appears when the balance is first switched on. Use this application to determine the weight of a sample within the device's specific weighing range.



Mixing (Secura® and Quintix® only; see page 46)

Use this application to weigh up to 99 components one after the other for a mixture or formula in one container. The balance is automatically tared after each component is weighed. The weight value of an individual component or the total weight can be displayed as desired.

**Statistics** (Secura® and Quintix® only; see page 49)

Use this application to save weight and calculated values and statistically analyze them. You can save up to 99 components.

**Components** (Secura® and Quintix® only; see page 52)

Totalize weight values. You can save up to 99 components that are weighed in various individual containers.

Each container can be tared before each component is weighed.

**Density** (see page 55)

Use this application to determine the density of solid samples using a density set based on the buoyancy method. The density is determined using Archimedes' Principle. The upward buoyant force exerted on a body immersed in a fluid is equal to the weight of the fluid the body displaces.

**Percentage** (see page 59)

This application is used to determine the percentage share or the percentage difference of the sample related to a reference weight.

**Conversion** (Secura® and Quintix® only; see page 62)

Use this application to multiply the weight value by a user-defined factor. The selected factor is saved to protected memory.

**Unstable condition** (see page 64)

Use this application with moving samples (such as live animals) and for weighing in unstable environments. A measurement cycle is automatically carried out with a defined number of measurements for each object to be weighed. The individual measurements are averaged, and this average is displayed as the result.

**Checkweighing** (see page 66)

Use this application to check whether a weight value falls within the specified tolerances. This application also makes it easy to fill sample materials to a specified target weight.

**Peak hold** (see page 68)

Use this application to calculate the maximum weight value of a sample (peak value). The value remains on the display for five seconds after the sample has been removed from the balance.

Example: Use for measuring release force during an experiment, or use when a load is so big that the balance display is hidden from view during weighing.

**Counting** (see page 70)

Use this application to determine the number of parts of approximately equal weight. The weight of a counted reference sample is calculated and then the objects with an unknown piece count are weighed. The balance displays the number of parts and the piece weight.

6. System Settings (Setup Menu)

The **Settings** (Setup menu) contain all basic settings for the balance.



Not all functions/settings are available on verified balances.

6.1 Accessing the Menu and Changing Settings



▶ Select the Menu key in any application.

▷ The menu appears.

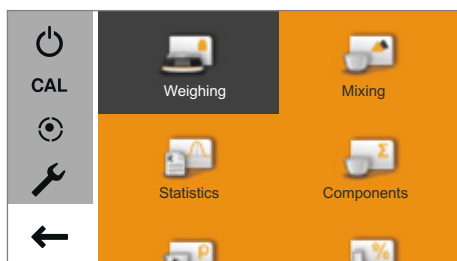

▶ To access the balance system settings, select  (Setup) in the menu.

▷ The **Settings** (Setup menu) appear.

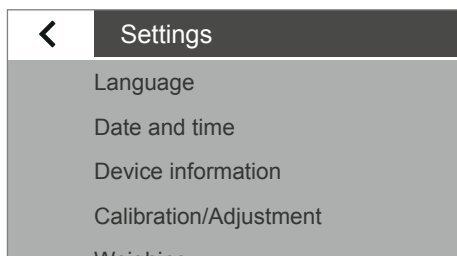

▶ To scroll through the menu, place a finger on the display and drag it slowly up or down.

▷ The settings in the menu move in the corresponding direction. A gray scrollbar appears on the right of the display when scrolling, indicating the current location in the list of options.

▶ Select a setting and make the desired changes. Information about available settings can be found from page 29.

▶ Select  to confirm your changes.

▶ Select  to return to the menu. The changed settings become active when you return to the first level of the menu.

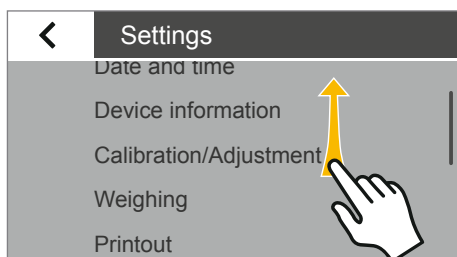

6.2 List of Available Settings

This section contains information on all basic balance settings which can be defined in the **Settings** menu.

6.2.1 Language

Set the display language here. English is the default language (see "Setting the Language" on page 29).

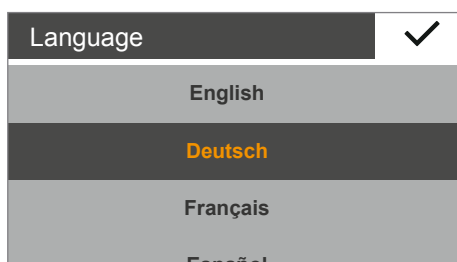

The following languages are available:

- English
- Deutsch (German)
- Français (French)
- Español (Spanish)
- Italiano (Italian)
- 日本語 (Japanese)
- Русский (Russian)
- 汉语 / 漢語 (Chinese)
- Polski (Polish)
- Português (Portuguese)
- 한국어 / 조선말 (Korean)
- Turkish
- Hungarian

Setting the Language

The display text is given in English as a default. To change the language, proceed as follows:

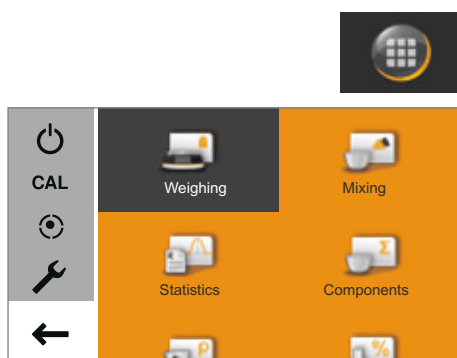

- ▶ In the Weighing screen, select the Menu key at the bottom left of the display.

- ▷ The menu is displayed.



- ▶ Select the  button (Setup) in the menu.

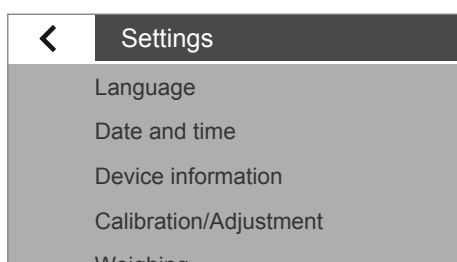

- ▷ The **Settings** window appears.

- ▶ Select **Language** or the top entry in the list.

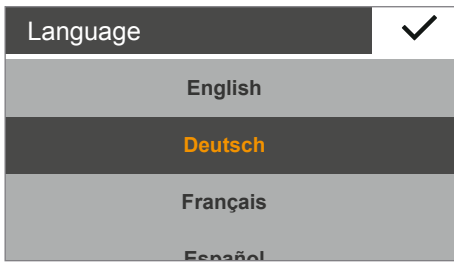

- ▷ The **Language** settings window appears.
- ▶ Select the desired language, such as **Deutsch (German)**.
- ▶ Select ✓ to confirm.
- ▷ The display immediately switches to the desired language.
- ▶ Select < to return to the menu.

6.2.2 Date and Time (Secura® and Quintix® only)

Set the date, time, and display format here.

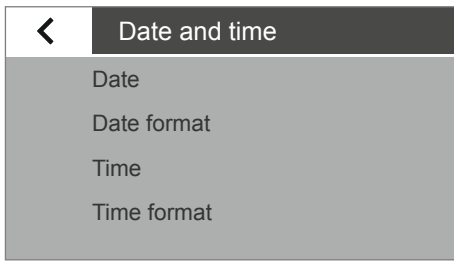

Date menu option:

- ▶ To set the date, select ···, enter the current date, and confirm with ✓.

Date format menu option:

- ▶ Choose how the date is displayed and printed.
 - **DD-MMM-YYYY:**
Displayed in order of day, month, and then year.
 - **MMM-DD-YYYY:**
Displayed in order of month, day, and then year.
 - **YYYY-MM-DD (ISO):**
Displayed in order of year, month, and then day.
(The time is given in 24-hour format when this setting is selected.)

Time menu option:

- ▶ To set the time, select ···, enter the current time, and confirm with ✓.

Time format menu option:

- ▶ Choose how the time is displayed and printed.
 - **24h:**
The time is displayed in 24-hour format. (This is the only possible setting when the date format is set to ISO.)
 - **12h (AM/PM)**
The time is displayed in 12-hour format. Times shown before noon are marked with **AM**, and times shown after noon are marked with **PM**.

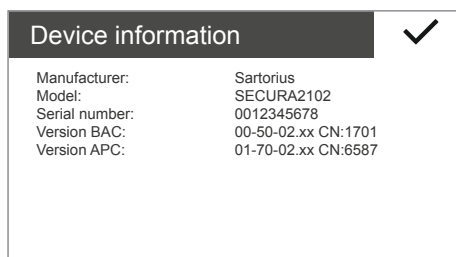

6.2.3 Device Information

The manufacturer, model, serial number, and software version of your balance are displayed here.

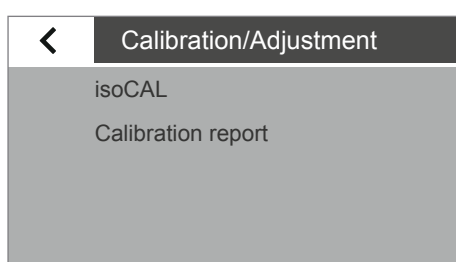

6.2.4 Calibration/Adjustment

With Secura® models, it is possible to set how the automatic calibration/adjustment function isoCAL is started.

With Secura® and Quintix® models, saved reports about the most recent calibration procedures, including deviations identified, can be viewed and output to a PC or Sartorius lab printer.

isoCAL menu option (Secura® only):

- ▶ Select the desired start option for isoCAL.
 - **Off:** isoCAL is switched off.
 - **Info, manual start:** A note appears on the display when predefined time intervals or temperature values are exceeded. isoCAL can be started manually.
 - **Automatic:** isoCAL is switched on. Calibration/adjustment starts automatically when predefined time intervals or temperature values are exceeded.

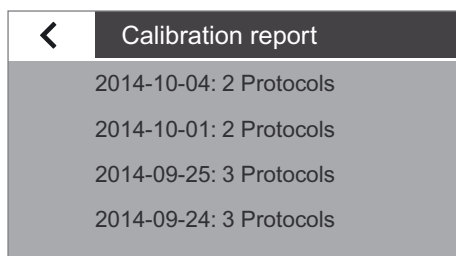

Calibration report menu option (Secura® and Quintix® only):

- ▶ Select the desired report by date. If there is more than one calibration report per date, use the < and > buttons to navigate through the reports.
- ▶ Select  to print the displayed report.



A maximum of 99 entries are saved per day. Calibration reports are deleted after 30 days.

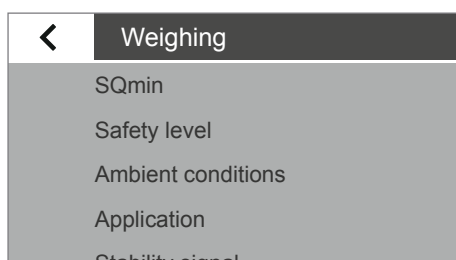

6.2.5 Weighing

A number of basic settings for the weighing functions can be defined here. Options are limited for verified balances. All settings given in the menu are permitted.

SQmin menu option (Secura® only):

If the SQmin function is set up on the balance, the function can be switched **On** or **Off** here (see "SQmin Minimum Weighing (Secura® only)" on page 44).

Safety Level

The Secura® models monitor the following at all times:

- whether the balance is leveled correctly
- whether adjustment is necessary
- whether minimum sample quantity requirements are met according to USP.

Safety level menu option (Secura® only):

- ▶ Select the desired safety level for **SQmin**, **isoCAL**, and **LEVEL**

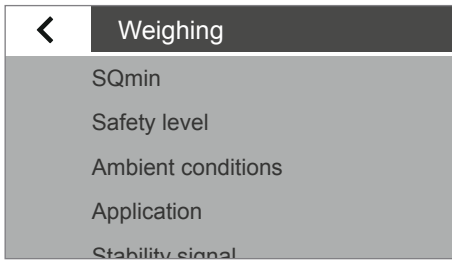

M

If a verified balance has not been leveled, the following functions will be disabled immediately (as is the case with the "High" safety level):

- Printout
- Startup and saving of application

Here, it does not matter what settings this menu item has.

High (factory setting): If one of the three conditions has not been met, a warning is displayed straight away. No data is transmitted.

The following functions are disabled immediately:

- Printout
- Startup and saving in applications

Displays:

- Information about red marking of display element (LEVEL, isoCAL or SQmin)
- Weight value displayed in gray with a black warning symbol

A warning is displayed after 60 seconds in the event of non-observance.

Standard: If one of the three conditions has not been met, a warning is displayed straight away.

Displays:

- Information about red marking of display element (LEVEL, isoCAL or SQmin)
- Weight value displayed in gray with a black warning symbol

A warning is displayed after 60 seconds in the event of non-observance.

Printout:

- Weight values are marked with "!"

Low: The following information is displayed:

- SQmin value has not been achieved -> SQmin value is marked red
- Balance not leveled -> Red marking on "LEVEL" display element
- Balance not adjusted due to temperature or time -> Red marking on "isoCAL" display element

Under **Ambient conditions:**

- ▶ Choose whether the conditions at the balance location are **Stable** or **Unstable**. If **Unstable** is selected, adverse ambient conditions (drafts, vibrations) are filtered by changing the measurement time for the weight values.

Under **Application:**

- ▶ Choose whether the balance will be used for **Weighing** or **Dosing**. This setting is used to compensate for load fluctuations on the display.
 - **Weighing:** The display responds very quickly to fast load changes. The display responds more slowly to small changes in weight (in the digit range). This setting is suitable for normal weighing.
 - **Dosing:** The display responds quickly to small changes in weight, making it faster and more accurate for additional dosing and container filling functions.

Under **Stability signal:**

- ▶ Choose whether stability is shown with **High accuracy**, **Medium accuracy** or **Fast** on the display. The balance stability is displayed as soon as the weighing result is constant within a defined range. Until stability is reached, the measured value is shown in gray on the display and only turns black once the balance is deemed stable.

Under **Zero/Tare:**

- ▶ Define settings for zeroing and taring.
 - **Zero/Tare function:** Choose whether the balance is zeroed and tared **With stability** or **Without stability**. If **Without stability** is selected, the balance is automatically tared when **•O•** or **•T•** is selected. If **With stability** is selected, the balance is tared the next time stability is reached after **•O•** or **•T•** is selected.
 - **Automatic zero (zero tracking function):** If this option is enabled, changes of a set fraction of scale intervals per second starting from the display zero point are automatically zeroed.
 - **Zero/Tare at power on:** If this option is enabled, the balance is automatically zeroed or tared when switched on.

6.2.6 Printout

You can configure the settings for printing and data output here. Some of the settings depend on the USB port configuration (see page 36).

Under **Printout**:

- ▶ Define the settings for outputting logs and reports to a connected lab printer.
 - **Manual:** The data is printed out when  is selected in the application.
 - **Automatic:** The data is printed out automatically.
 - **Without stability:** No stability is required for a printout. The printout does not have any unit symbols in this case.
 - **With stability:** The data can only be printed out when stability is reached.
 - **Print after weight change:** Data is printed once, after a threshold has been exceeded at stability and the weight has previously been reduced to less than half of the threshold.

Under **Manual print**:

This option can be selected when Manual print has been set in the **Printout** menu.

- ▶ Define the settings for the Manual print.
 - **ISO/GLP printout** (Secura[®] and Quintix[®] only): Activate this option when an ISO/GLP-compliant printout is required.
 - **Tare after print:** Activate this option to automatically tare the balance after printing.
 - **Manual print format:** Select the information to be printed during manual printing, such as date and value.
Value without ID: only if being transmitted to a PC (menu items: USB port: Device/protocol: PC – xxx)
Value or **Date, value** or **Value (N, T, G#)** or **Date, value (N, T, G#)**
 Only for Secura[®] and Quintix[®]

Under **Automatic print**:

This option can be selected when Automatic print has been set in the **Printout** menu.

- ▶ Define the settings for the automatic print.
 - **Autom. print interval:**
 - **Interval time:**
Choose from the last three interval times or enter the desired interval time in seconds via t and confirm with I (factory setting: 5 seconds).
 - Select the Standard option to use a model-specific output rate for weight determination.
 - **Autom. print format:** Select the information to be printed during automatic printing, such as date and value.
Value without ID: only if being transmitted to a PC (menu items: USB port: Device/protocol: PC – xxx)
Value or **Date, value:** only for Secura[®] and Quintix[®]

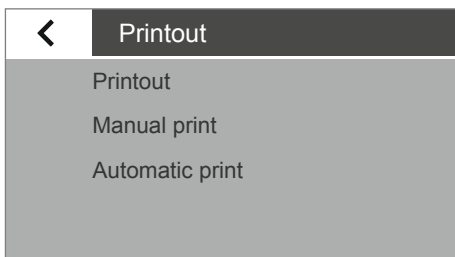

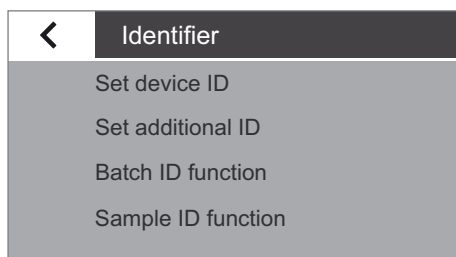

6.2.7 Identifier (Secura® only)

Define identifiers for the printout via the  button and in the ISO/GLP printout here. Under **Printout** in **Manual print**, the **ISO/GLP printout** option must be activated. IDs can be a maximum 14 characters long.

Set device ID menu option:

The device identification (ID) is printed in the header of the GLP printout.

- ▶ To activate the device ID, select ···, enter the desired device ID, and confirm with ✓.

Set Additional ID menu option:

The additional ID (A ID) is also printed in the header of the GLP printout.

- ▶ To activate the additional ID, select ···, enter the desired device ID and confirm with ✓.

Batch ID function menu option:

The batch ID (L ID) is queried one time at the start of the GLP printout.

- ▶ Activate this option to enter or print out the batch ID.

Sample ID function menu option:

The sample ID (S ID) can be activated for each printout by selecting the  button on the balance display.

- ▶ Define settings for printing the sample ID.
 - **On:** The sample ID is activated. This ID is queried before each printout.
 - **Autom. increment:** Select this option to automatically assign the sample ID in ascending order.
 - **Autom. decrement:** Select this option to automatically assign the sample ID in descending order.
 - **Off:** The sample ID is deactivated.



To enter and delete figures and text, e.g., for the sample ID, see “Enter Figures on the Keypad” on page 25.

6.2.8 USB Port

Define the settings for data transmission to a peripheral device (e.g. a printer or PC) here.

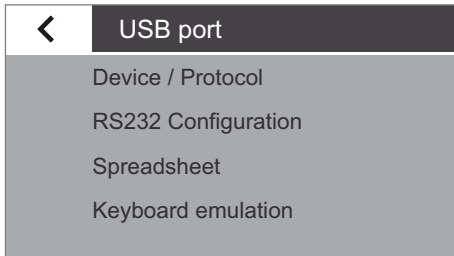

In legal metrology data can be transmitted to a PC and used with an Alibi memory. The balance does not have its own Alibi memory. Connection to a printer or Alibi printer is permitted.

Various options are available in the menu depending on the cable and peripheral device connected to the balance. The balance automatically detects the connection type.

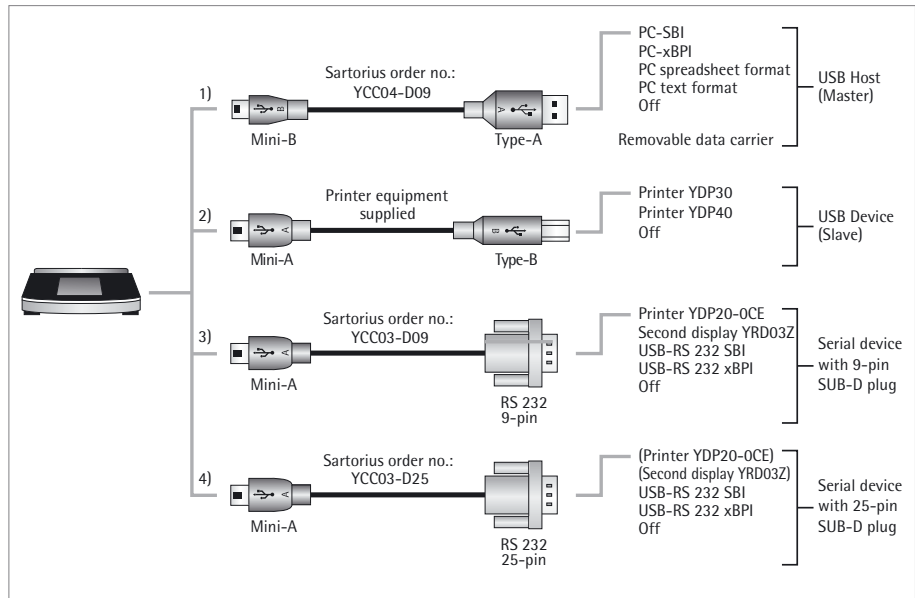

There are several ways to connect the balance via USB:

1) Connection with a PC via USB cable (Mini B for USB A)

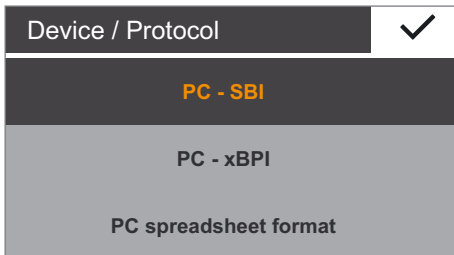

- Device / Protocol** menu option:
- ▶ Select the data format for transfer to the PC.
 - **PC - SBI:** Driver for PC required (CDC Virtual Com Port). The data is output via SBI protocol through a virtual serial interface. See page 83 onwards for more on the driver and SBI.
 - **PC - xBPI** (Secura® and Quintix® only): Driver for PC required (CDC Virtual Com Port). The data is output via xBPI protocol through a virtual serial interface. See page 83 onwards for more on the driver and xBPI.
 - **PC spreadsheet format:** The balance transmits the data in table format using shortcuts (keyboard emulation) to the application currently open on the PC.
 - **PC text format:** The balance transmits the data in tabular format via shortcuts (keyboard emulation) to the application currently open on the PC.
 - **Off:** Data transmission is deactivated.

Additional menu option if "PC spreadsheet format" has been selected:

In **Spreadsheet** menu option:

- **Decimal markers:**
 - **Decimal point** (factory setting): The numerical value is copied to the PC program with a decimal point (e.g. 99.963 g).
 - **Decimal comma:** The value is copied to the PC program with a decimal comma (e.g. 99,963 g).

Additional menu option if "PC spreadsheet format" has been selected:

In **Spreadsheet** menu option:

- **Output format:**
 - **Text and numerical value** (factory setting):
Transmits the output with ID, value and unit, across several lines if necessary
 - **Numerical value only:** Outputs numerical value only, in one line (without ID and unit) (date, value or net/tare/gross).

Additional menu option if "PC spreadsheet format" or "PC text format" has been selected:

In Keyboard **Emulation** menu option:

- **Universal (Num Lock On)** (factory setting): Transmits the data as special keyboard characters, in ASCII format ("Alt"+ keypad).
"Num Lock" must be on on the PC keyboard.
- **English (USA):** Transmits the data using the "EN English (USA)" keyboard format. The keyboard setting for MS Excel (etc.) must be "EN English (USA)" for the PC application.



More information can be found in the "USB Port" chapter on page 79.

2) Connection with Sartorius lab printer via the supplied printer cable

Device / Protocol menu option:

- ▶ Select the desired setting for connection to the printer.
 - **YDP30 | YDP40:** The connected printer is automatically detected and the connection is established.
 - **Off:** The connection to the printer is deactivated.

3) and 4) Connection to a serial printer or another external serial device via a 9-/25-pin serial interface (USB Mini A for RS-232)

Device / Protocol menu option:

- ▶ Select the desired setting for connection to the device.
 - **Printer YDP20-OCE**
 - **Second display YRD03Z**
 - **USB-RS-232 SBI**
 - **USB-RS-232 xBPI** (Secura® and Quintix® only)
 - **Off:** The connection is deactivated.

RS-232 Configuration menu option:

This option can be selected by going to **Device / Protocol** and choosing the **USB-RS-232 SBI** setting.

- ▶ Select the desired setting for the RS-232 interface.
 - **Baudrate:** 600 to 19,200 (factory setting: 9600)
 - **Databits:** 7 Bits or 8 Bits (default: 8 Bits)
 - **Parity:** Odd, Even, or None (default: Odd)
 - **Stopbits:** 1 Bit or 2 Bits (default: 1 Bit)
 - **Handshake:** Software (XON, XOFF), Hardware (CTS, RTS), or Off [default: Hardware (CTS, RTS)]

6.2.9 Display Brightness

Set the display brightness here.

The following brightness levels are available:

- **Bright**
- **Medium**
- **Eco mode:** energy-saving mode (default). Brightness is reduced after two minutes of inactivity. Press any key to return to normal brightness.

6.2.10 Acoustic signal

Set the volume of the acoustic signal here.

The following volume levels are available:

- **Loud**
- **Medium**
- **Low**
- **Off**

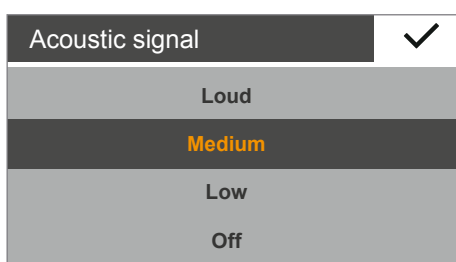
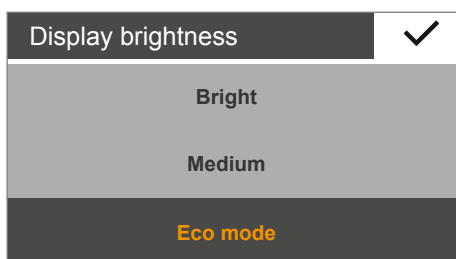

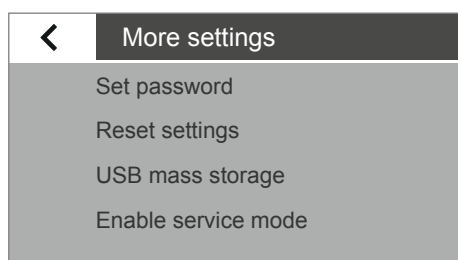

6.2.11 More Settings

Additional service functions for the balance can be found here.

Set password menu option (Secura® only):

Secura® models can be password-protected to prevent unauthorized personnel from making changes to the system settings of the balance.

When a user password is set, all settings which could change the metrological behavior of the balance are locked.

- ▶ Select **...**.
- ▶ Enter a number as a password.
To make corrections to the entry:
 - **←** button: delete individual characters.
 - **C** button: delete all characters.
- ▶ Enter the password again to ensure correct entry.
- ▶ Confirm with **✓**.
- ▶ The new password will only be applied after returning to the first level of the menu.



To change the password, the old password must first be entered.

A new password can then be set.

To completely delete the password and use the balance without password protection, leave the entry blank.

Contact the Sartorius Service Center if you forget the password.

Reset settings menu option:

Reset all balance settings to the factory (default) settings here.

- ▶ When the prompt appears, select **Yes, reset** and confirm with **✓**. The balance is reset and restarts.

USB mass storage menu option:

Use this function to register the balance memory as a USB removable data carrier on a PC. This function is required by the Sartorius Service Center or when installing the PC driver for the virtual COM port. Further information can be found in Chapter "USB Port" on page 79.

Enable service mode menu option:

This function is used by the Sartorius Service Center and can only be accessed by authorized Service Center personnel. The following service functions are available:

- Preset value for minimum weighing (SQmin)
- Enter date for next service
- Reset all settings to factory settings

The **Calibration/Adjustment** menu also provides the following functions for authorized Service personnel (depending on the model):

- External linearization (not for use in legal metrology)
- Set the preload
- Delete the preload



These functions are not available for verified and sealed balances.

Lock Menu (Quintix® and Practum®)

Use this function to lock or unlock the menu.

- ▶ Hold down the Menu key for longer than 10 seconds.
- ▶ Confirm with Lock.

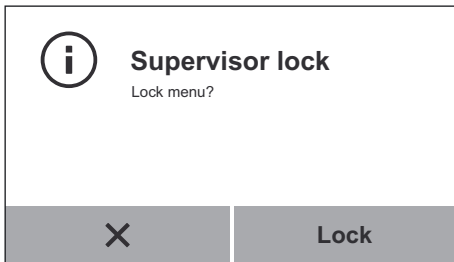

Accessing the menu or unlocking it again:

- ▶ Hold down the Menu key for longer than 10 seconds.
- ▶ Then select the required function.

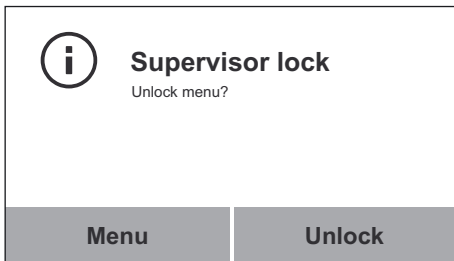

7. Weighing

Purpose: Use this application to determine the weight of a sample within the device's specific weighing range (see "Specifications").



- ▶ Select the Menu key in any application.
- ▶ Select the **Weighing** symbol in the menu.

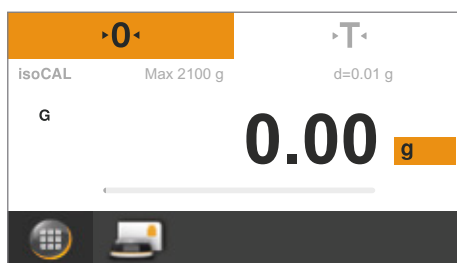

- ▶ The **Weighing** application appears.

Zero



- ▶ Remove the load from the balance.
- ▶ Select **0** to zero the balance.
All weight values are measured based on this zero point (zeroing within $\pm 2\%$ of the weighing range around the zero point).

Tare



- ▶ Place an empty container on the balance, if weighing with containers.
- ▶ Select **T** to tare the balance.
The balance displays zero again after being tared.
The tared value is subtracted from the overall weighing range of the balance.
The balance can be tared throughout its entire weighing range.

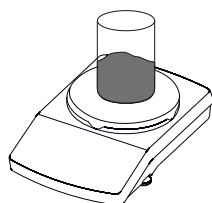

- ▶ Place the sample on the weighing pan.

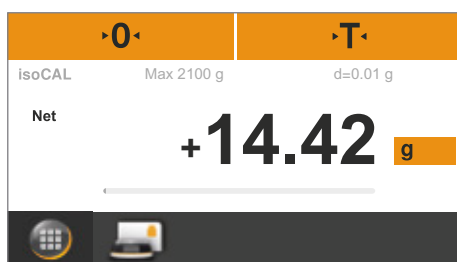

- ▶ The measured value can be read as soon as the weight value stops changing and the unit is displayed.
The balance stability is displayed as soon as the weighing result is constant within a defined range. Until stability is reached, the measured value is shown in gray on the display and only turns black once the balance is deemed stable.

7.1 Mass Unit Conversion

Purpose: Configure the weight unit and accuracy of the weight value.



Not all units can be selected on balances used for legal metrology. The user can only switch between metric units (milligram, gram, kilogram).



▶ To switch to another unit, select the Unit button on the weighing display.

▷ The **Unit / Accuracy** menu appears.

Unit / Accuracy ✓	
g	All digits on
kg	Last digit autom. off
ct	Last digit off
lb	Reduced by 2 digits

The left list contains the available units. The currently selected unit is marked (e.g., **g**). The most recently selected units automatically appear at the top of the list. Units which are rarely or never used are shown further down the list. The right list contains the display accuracy options. The currently selected setting is marked (e.g., **All digits on**).

▶ Select the unit in which the weight result is displayed (e.g., **g, kg, ct, lb**).

▶ Select the display accuracy (e.g., **All digits on** or **Last digit off**). The display accuracy can be individually assigned to each unit.

▶ Select ✓ to confirm.

▷ The weighing display appears with the changed settings. This setting remains until the selection is changed.



There is an online animation for this application. Click here to view it:



Conversion Factors for Weight Units

The table contains common weight units and their conversion factors in relation to the gram. The balance can work in the following units as and when needed (with verified balances, this is only possible if the country's laws regarding legal metrology and verification permit this):

Unit	Factor	Display
Gram	1.000000000000	g
Kilogram	0.001000000000	kg
Carat	5.000000000000	ct
Pound	0.00220462260	lb
Ounce	0.03527396200	oz
Troy ounces	0.03215074700	ozt
Hong Kong tael	0.02671725000	tlh
Singapore tael	0.02645544638	tls
Taiwanese tael	0.02666666000	tlt
Grain	15.43235835000	GN
Pennyweight	0.64301493100	dwt
Milligram	1000.000000000000	mg
Parts per pound	1.12876677120	/lb
Chinese tael	0.02645547175	tlc
Momme	0.2666666666666667	mom
Austrian carat	5.000000000000	Kt
Tola	0.08573333810	tol
Baht	0.06578947437	bat
Mesghal	0.21700000000	MS
Newton	0.00980665000	N



Some weight units and accuracy settings may be blocked from use in verified balances, depending on national laws regarding legal metrology and verification.



Depending on the country-specific model version, not all weight units listed may be available.

7.2 SQmin Minimum Weighing (Secura® only)

Purpose: This function is used to compare the weight value with the defined minimum sample quantity (SQmin = sample quantity minimum). This ensures that weighing results are above the specified minimum weight defined by your quality assurance system. This function is used to observe the minimum weight in order to meet the criteria of the United States Pharmacopeia (USP), for example.

M

SQmin is not the same as the minimum capacity Min in legal metrology.

Prerequisites: The balance must be set up by a service technician to be able to use the SQmin function. The technician will determine the permitted minimum sample quantity and load this to your balance using the guidelines of your QA system. He will document this setting via a "Weighing module test as per USP" certificate in which the measurements and min. sample quantity are logged. The SQmin function ensures that the weighing results correspond to USP guidelines.

Switching SQmin On/Off

If the SQmin function is set up on the balance, go to the **Settings** menu, **Weighing – SQmin** to switch it on/off.

Display of SQmin Function during Weighing

- ▶ Place the sample on the weighing pan.
- ▷ The SQmin value is displayed in red if the weight value is smaller than the specified minimum weight. The weight value is displayed in gray if it is smaller than the specified SQmin value. The weight value cannot be saved or printed out in applications (depending on the setting in the "Safety level" menu).

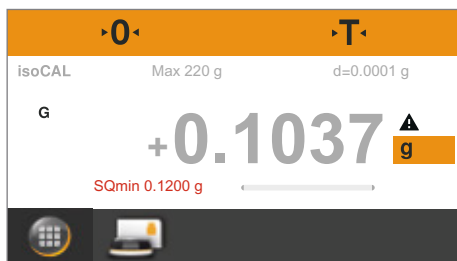

7.3 Individual Identifiers (Secura® only)

- Purpose: You can define identifiers for the following print jobs:
- Device identification (ID): printed in header of GLP printout.
 - Additional ID (A ID): printed in header of GLP printout.
 - Batch ID (L ID): queried after each GLP head in GLP printout at beginning of measurement.
 - Sample ID (S ID): for printouts via the  button. This ID is queried before each printout.

- Prerequisites:
- The balance must be connected to a Sartorius lab printer or PC for printouts (see "USB Port" on page 79).
 - The settings for individual identifiers can be configured in the system settings under **Identifier** (see "Identifier (Secura® only)" on page 35).
 - The GLP printout can be activated in the system settings under **Print function** in **Manual print** (see "Printout" on page 34).

Starting the Printout

Example: Configuration of system settings for printing sample ID (S ID):
Identifier – Sample ID function – Autom. increment:

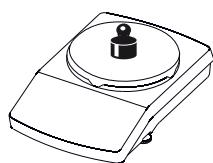

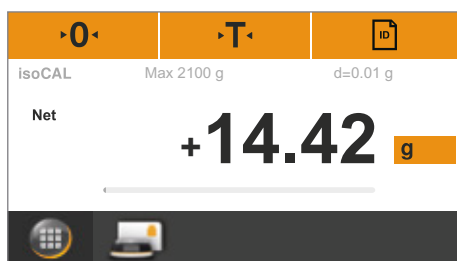

- ▶ Place the sample on the weighing pan.

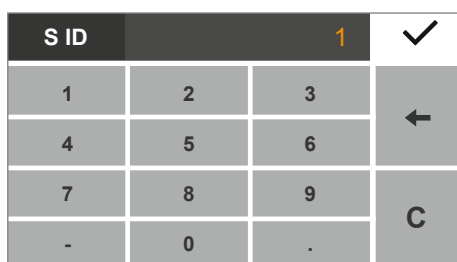

- ▶ Select  to print.



- ▶ The identifier for the printout is displayed. The displayed value can be changed if desired.
 - Delete the last character: Select .
- ▶ Select  to confirm.

- ▶ The weight value is printed. A sample printout can be seen below:

```

-----
S I D                11
N      +           200.21 g
S I D                12
N      +           200.19 g
  
```

7.4 Mixing (Secura® and Quintix® only)

Purpose: Use this application to weigh up to 99 components one after the other for a mixture or formula in one container. The balance is automatically tared after each component is weighed. The weight value of an individual component or the total weight can be displayed as desired.

Example: You want to weigh several components of a formula in one container.



▶ Select the Menu key in any application.



▶ Select the **Mixing** symbol in the menu.

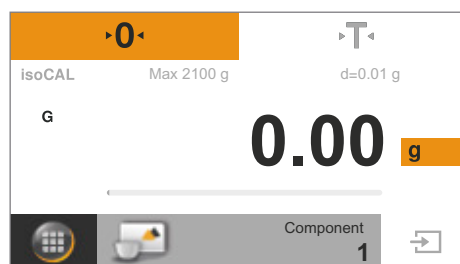

▷ The **Mixing** application appears.

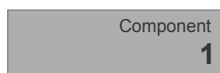

▶ To change settings, select the gray button.

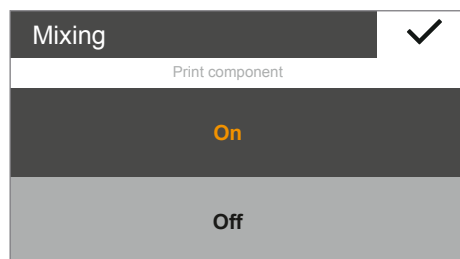

▷ The **Mixing** settings window appears.

▶ Choose whether the individual weights of the components are printed out when a printer is connected.
▶ Select ✓ to confirm.



▶ Select **0** to zero the balance if necessary.

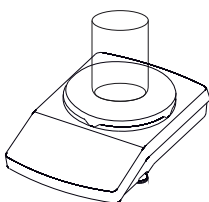

▶ Place a container on the weighing pan.



▶ Select **T** to tare.

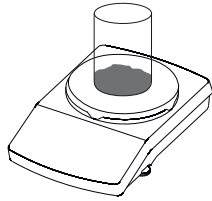

- ▶ Place the first component on the weighing pan.



- ▶ The weight value is displayed.



- ▶ To save the component, select .

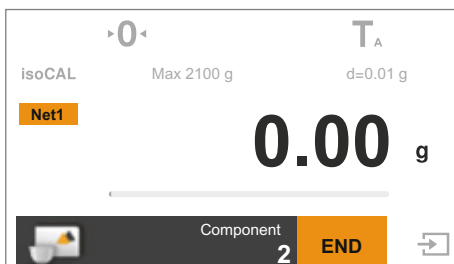

- ▶ The component is saved, and the balance is automatically tared.

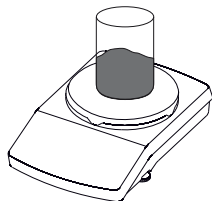

- ▶ Place the next component on the weighing pan.



- ▶ To save the component, select .

- ▶ Continue this procedure with additional formula components.

Net1

- ▶ To view the total weight, select the **Net1/Total** button on the weighing display.

- ▷ The total weight is displayed.

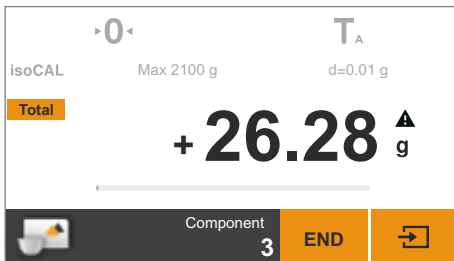
**Total**

- ▶ To change back to viewing the individual weights of each component, select the **Net1/Total** button again.

END

- ▶ To exit the function, select **END**.
- ▷ The total weight is displayed and the application switches back to its original state.

Printing Results

Prerequisites: For printouts, a printer (e.g., Sartorius YDP40) or PC must be connected and configured (see "USB Port" on page 79).

In the **Mixing** settings window the **Print component** option must be set to **On**.

- ▷ If a printer is connected, an additional button automatically appears at the top right of the display.

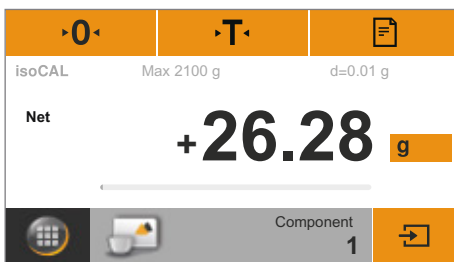

- ▷ When each component is saved, their weight value is printed (**Comp 1**, **Comp 2**, etc.)
- ▷ Select **END** to print the total weight (**T-Comp**).
- ▷ A sample printout is given below:

```
-----
Comp1 +      14.33 g
Comp2 +       5.97 g
Comp3 +       5.98 g
T-Comp+      26.28 g
```



There is an online animation for this application. Click here to view it:



7.5 Statistics (Secura® and Quintix® only)

Purpose: Save weight values and statistically evaluate them. You can save up to 99 components. The values are generated as results:

- Number of components
- Average
- Standard deviation
- Variation coefficient
- Sum of all values
- Lowest value (minimum)
- Highest value (maximum)
- Spread: Difference between maximum and minimum

Prerequisites: For printouts, a printer must be connected and configured (see "USB Port" on page 79).



▶ Select the Menu key in any application.



▶ Select the **Statistics** symbol in the menu.

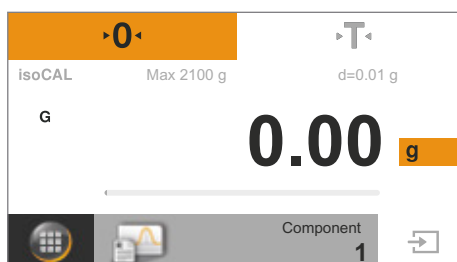

▶ The **Statistics** application appears.

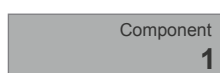

▶ To change settings, select the gray button.

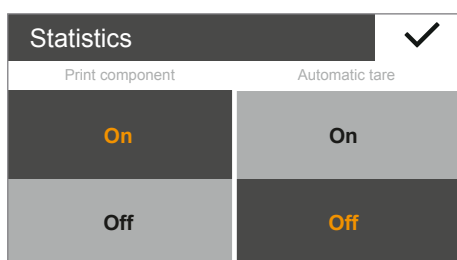

▶ The **Statistics** settings window appears.

- ▶ Choose whether the individual weights of the components are printed out.
- ▶ Determine whether the balance is tared when a component is saved.
- ▶ Select ✓ to confirm.



▶ Select **0** to zero the balance if necessary.

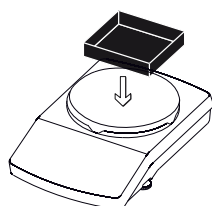

▶ Place a container on the weighing pan.



▶ Select **T** to tare.

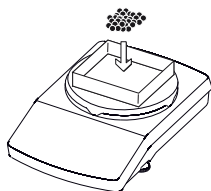

▶ Place the first component on the weighing pan.

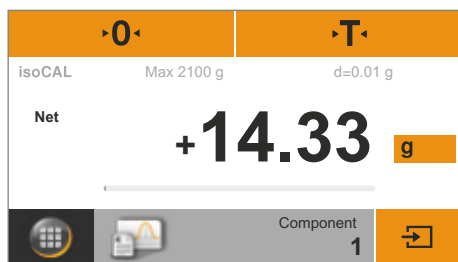

▷ The weight value is displayed.



▶ To save the component, select .

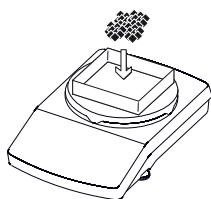

▶ Remove the first component from the weighing pan and place the next component on the balance.



▶ To save the component, select .

▶ Continue this procedure with additional components.

▷ The weight values of the saved components (**Comp1**, **Comp2**, etc.) are printed on the connected printer.

A sample printout can be seen below:

Comp1	+	14.33	g
Comp2	+	8.47	g
Comp3	+	18.30	g
Comp4	+	13.19	g
Comp5	+	13.18	g



▶ To display the intermediate result for previously saved components, select .

Report	
Number of components:	n 5
Average:	x 13.49 g
Standard deviation:	s 3.60 g
Variation coefficient:	sRel 27 %
Total:	Sum 67.47 g
Minimum:	Min 8.47 g
Maximum:	Max 18.30 g
Spread:	Diff 9.83 g

- ▷ The following values are displayed as an intermediate result:
 - Number of saved components
 - Average
 - Standard deviation
 - Variation coefficient
 - Sum of all values
 - Lowest value (minimum)
 - Highest value (maximum)
 - Spread: Difference between maximum and minimum



- ▶ To print the intermediate result, select .
- ▷ The analysis is printed on the connected printer as it appears in the report (n, x, s, sRel, etc.).
A sample printout can be seen below:

n		5
x	+	13.49 g
s	+	3.60 g
sRel	+	27.00 %
Sum	+	67.47 g
Min	+	8.47 g
Max	+	18.30 g
Diff	+	9.83 g



- ▶ To switch back to the **Statistics** application, select **X**.

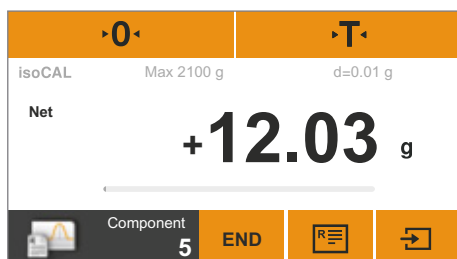

- ▶ Weigh additional components, if any, and display the updated intermediate result.



- ▶ To exit the function, select **END**.
- ▷ The application returns to its original state.



There is an online animation for this application. Click here to view it:



7.6 Totalizing Components (Secura® and Quintix® only)

Purpose: Totalize weight values. You can save up to 99 components. This allows you to save components that must be weighed in various containers. Each container can be tared before each component is weighed.

Example: You have a formula, the components of which should not be mixed together immediately. Use this application to weigh individual components in different containers, print out the results, and check the total weight at any time.



▶ Select the Menu key in any application.



▶ Select the **Components** symbol in the menu.

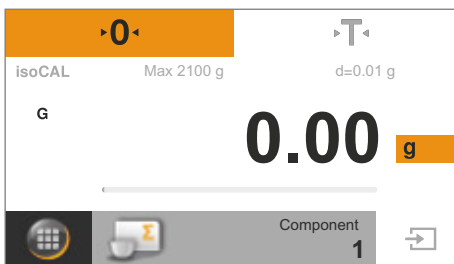

▶ The **Components** application appears.

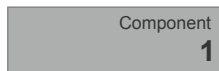

▶ To change settings, select the gray button.

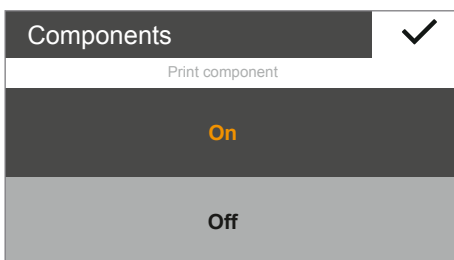

▶ The **Components** settings window appears.

- ▶ Choose whether the individual weights of the components are printed out.
- ▶ Select ✓ to confirm.



▶ Select **0** to zero the balance if necessary.

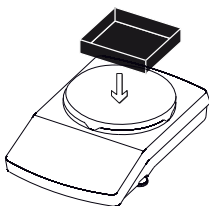

▶ Place the container for the first component on the weighing pan.



▶ Select **T** to tare.

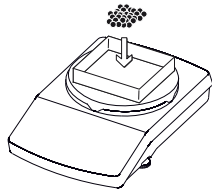

- ▶ Place the first component on the weighing pan.

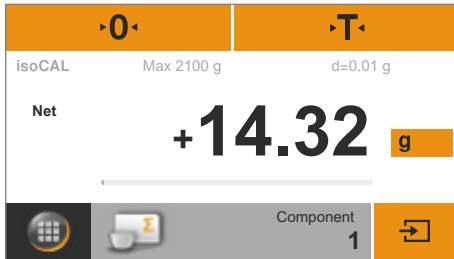

- ▶ The weight value is displayed.



- ▶ To save the component, select .

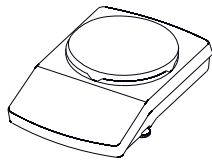

- ▶ Remove the load from the balance.

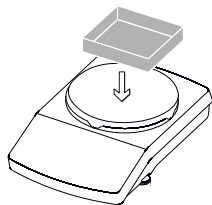

- ▶ Place the container for the second component on the weighing pan.



- ▶ Select **T** to tare.

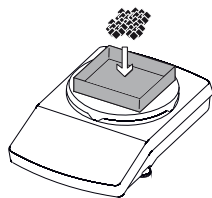

- ▶ Place the second component on the weighing pan.



- ▶ To save the component, select .

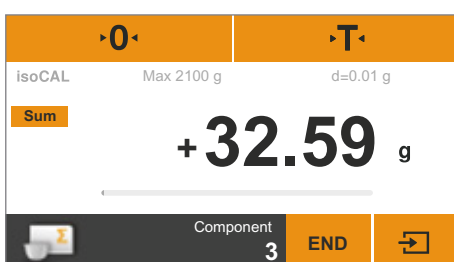

- ▶ The weight value is displayed.

- ▶ Continue this procedure with additional components.
- ▶ To view the total weight, select the **Net** button on the weighing display.
- ▷ The total weight of all saved components is displayed.

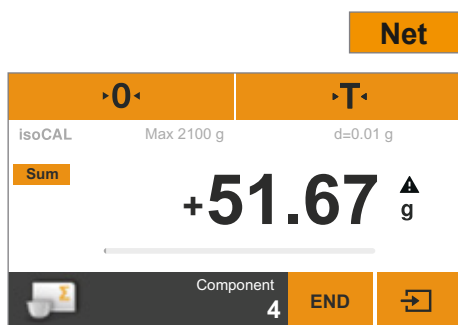

Sum

- ▶ To switch back to view individual weights, select the **Sum** button.

END

- ▶ To exit the function, select **END**.
- ▷ The application returns to its original state.

Printing Results

Prerequisites: For printouts, a Sartorius printer YDP40 or PC must be connected and configured (see "USB Port" on page 79).

- ▷ If a printer is connected, an additional button automatically appears at the top right of the display.
- ▶ Select  to print the current value.

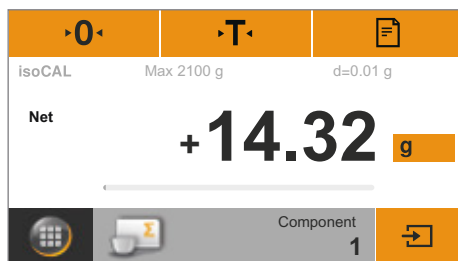

- ▷ When each component is saved, their weight value is printed (**Comp1**, **Comp2**, etc.)
- ▷ Select **END** to print the total weight (**T-Comp**).
- ▷ A sample printout is given below:

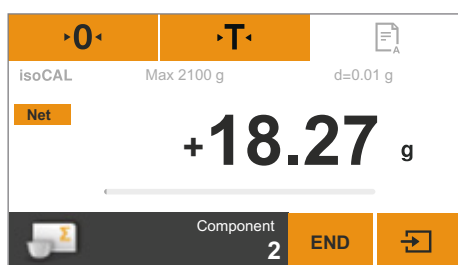

```

-----
Comp1 +      14.32 g
Comp2 +      18.27 g
Comp3 +      13.73 g
T-Comp+     51.67 g
  
```



There is an online animation for this application. Click here to view it:



7.7 Density

Purpose: The density of solids can be determined using the buoyancy method. The density is determined using Archimedes' Principle. The upward buoyant force exerted on a body immersed in a fluid is equal to the weight of the fluid the body displaces.

Calculation Basis for Density Determination

Density determination using the buoyancy method is based on the following formula:

ρ Density of sample (rho)
 ρ_{fl} Density of buoyancy liquid
 W_a Weight of sample in air
 W_{fl} Weight of sample in liquid

Buoyancy: $\rho = (W_a / (W_a - W_{fl})) * \rho_{fl}$

Prerequisites: A Sartorius density determination kit is required for this function:

- for analytical balances YDK03
- for precision balances YDK04.

Mount the density determination kit on the balance and prepare it as described in the kit instructions.



- ▶ Select the Menu key in any application.



- ▶ Select the **Density** symbol in the menu.

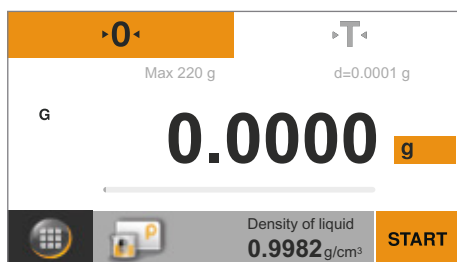

- ▶ The **Density** application appears. The density of the buoyancy liquid is displayed under **Density of liquid**. The following values are preset for distilled water at various temperatures:
 - 0.99823 g/cm³ at 20°C
 - 0.99802 g/cm³ at 21°C
 - 0.99780 g/cm³ at 22°C

Additional density values can be found in the table on page 58.

Density of liquid
0.9982 g/cm³

▶ To change the density of the buoyancy liquid, select the gray button.

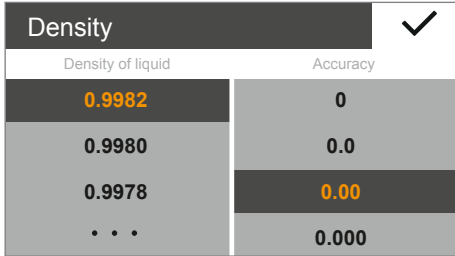

▶ The **Density** settings window appears.

- ▶ Enter the density of the buoyancy liquid on the left. Select a value or select ···, enter the desired value, and confirm with ✓.
- ▶ Select the accuracy of the density result on the right.
- ▶ Select ✓ to confirm.

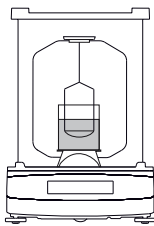

- ▶ Attach the sample holder to the frame of the density determination kit.
- ▶ Fill the beaker in the density determination kit with the buoyancy liquid. Ensure that the sample holder is sufficiently immersed in the liquid in order to hold the sample later.
- ▶ If distilled water is used as the buoyancy liquid, add three drops of tenside to reduce the effect of surface tension on the measurement result.



▶ Select **T** to tare.

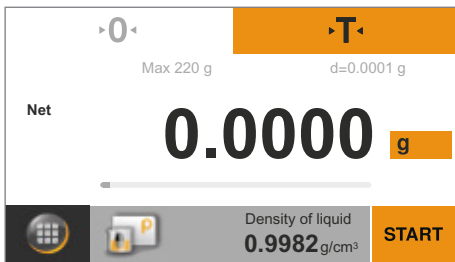

▶ The balance is tared with the prepared density determination kit.



▶ To begin density determination, touch **START**.

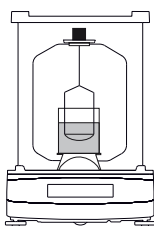

▶ Place the sample on the weighing pan above on the frame of the density determination kit.

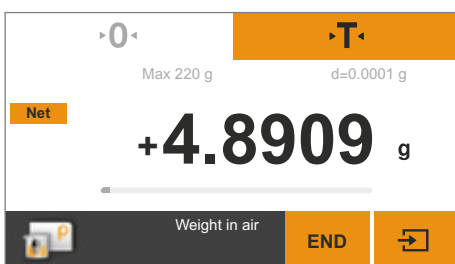

▶ The weighing display shows the step **Weight in air**.



- ▶ To save the weight value, select .

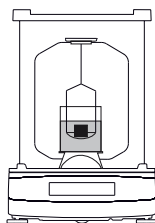

- ▶ Remove the sample from the weighing pan and place it in the sample holder of the density determination kit using forceps.
- ⚠ Ensure that the sample is completely submerged in the buoyancy liquid and that no air bubbles have formed on the sample.

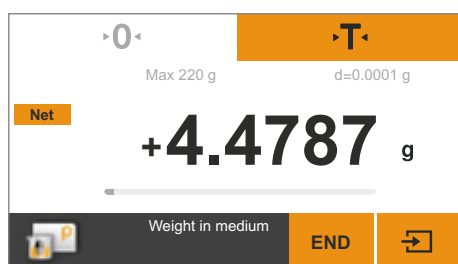

- ▶ The weighing display shows the step **Weight in medium**.



- ▶ To save the weight value, select .

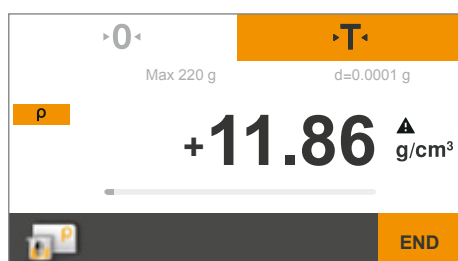

- ▶ The balance calculates the density of the sample and displays this value.

END

- ▶ To exit the function, select **END**.
- ▶ The application switches back to its original state. If the GLP printout function is activated, the GLP printout is automatically printed (see "Printout" on page 34).



There is an online animation for this application. Click here to view it:



Density Values of H₂O at Temperature T (in °C)

T/°C	0.0	0.1	0.2	0.3	0.4	0.5	0.6	0.7	0.8	0.9
10.	0.99973	0.99972	0.99971	0.99970	0.99969	0.99968	0.99967	0.99966	0.99965	0.99964
11.	0.99963	0.99962	0.99961	0.99960	0.99959	0.99958	0.99957	0.99956	0.99955	0.99954
12.	0.99953	0.99951	0.99950	0.99949	0.99948	0.99947	0.99946	0.99944	0.99943	0.99942
13.	0.99941	0.99939	0.99938	0.99937	0.99935	0.99934	0.99933	0.99931	0.99930	0.99929
14.	0.99927	0.99926	0.99924	0.99923	0.99922	0.99920	0.99919	0.99917	0.99916	0.99914
15.	0.99913	0.99911	0.99910	0.99908	0.99907	0.99905	0.99904	0.99902	0.99900	0.99899
16.	0.99897	0.99896	0.99894	0.99892	0.99891	0.99889	0.99887	0.99885	0.99884	0.99882
17.	0.99880	0.99879	0.99877	0.99875	0.99873	0.99871	0.99870	0.99868	0.99866	0.99864
18.	0.99862	0.99860	0.99859	0.99857	0.99855	0.99853	0.99851	0.99849	0.99847	0.99845
19.	0.99843	0.99841	0.99839	0.99837	0.99835	0.99833	0.99831	0.99829	0.99827	0.99825
20.	0.99823	0.99821	0.99819	0.99817	0.99815	0.99813	0.99811	0.99808	0.99806	0.99804
21.	0.99802	0.99800	0.99798	0.99795	0.99793	0.99791	0.99789	0.99786	0.99784	0.99782
22.	0.99780	0.99777	0.99775	0.99773	0.99771	0.99768	0.99766	0.99764	0.99761	0.99759
23.	0.99756	0.99754	0.99752	0.99749	0.99747	0.99744	0.99742	0.99740	0.99737	0.99735
24.	0.99732	0.99730	0.99727	0.99725	0.99722	0.99720	0.99717	0.99715	0.99712	0.99710
25.	0.99707	0.99704	0.99702	0.99699	0.99697	0.99694	0.99691	0.99689	0.99686	0.99684
26.	0.99681	0.99678	0.99676	0.99673	0.99670	0.99668	0.99665	0.99662	0.99659	0.99657
27.	0.99654	0.99651	0.99648	0.99646	0.99643	0.99640	0.99637	0.99634	0.99632	0.99629
28.	0.99626	0.99623	0.99620	0.99617	0.99614	0.99612	0.99609	0.99606	0.99603	0.99600
29.	0.99597	0.99594	0.99591	0.99588	0.99585	0.99582	0.99579	0.99576	0.99573	0.99570
30.	0.99567	0.99564	0.99561	0.99558	0.99555	0.99552	0.99549	0.99546	0.99543	0.99540

Density Values of Ethanol at Temperature T (in °C)

T/°C	0.0	0.1	0.2	0.3	0.4	0.5	0.6	0.7	0.8	0.9
10.	0.79784	0.79775	0.79767	0.79758	0.79750	0.79741	0.79733	0.79725	0.79716	0.79708
11.	0.79699	0.79691	0.79682	0.79674	0.79665	0.79657	0.79648	0.79640	0.79631	0.79623
12.	0.79614	0.79606	0.79598	0.79589	0.79581	0.79572	0.79564	0.79555	0.79547	0.79538
13.	0.79530	0.79521	0.79513	0.79504	0.79496	0.79487	0.79479	0.79470	0.79462	0.79453
14.	0.79445	0.79436	0.79428	0.79419	0.79411	0.79402	0.79394	0.79385	0.79377	0.79368
15.	0.79360	0.79352	0.79343	0.79335	0.79326	0.79318	0.79309	0.79301	0.79292	0.79284
16.	0.79275	0.79267	0.79258	0.79250	0.79241	0.79232	0.79224	0.79215	0.79207	0.79198
17.	0.79190	0.79181	0.79173	0.79164	0.79156	0.79147	0.79139	0.79130	0.79122	0.79113
18.	0.79105	0.79096	0.79088	0.79079	0.79071	0.79062	0.79054	0.79045	0.79037	0.79028
19.	0.79020	0.79011	0.79002	0.78994	0.78985	0.78977	0.78968	0.78960	0.78951	0.78943
20.	0.78934	0.78926	0.78917	0.78909	0.78900	0.78892	0.78883	0.78874	0.78866	0.78857
21.	0.78849	0.78840	0.78832	0.78823	0.78815	0.78806	0.78797	0.78789	0.78780	0.78772
22.	0.78763	0.78755	0.78746	0.78738	0.78729	0.78720	0.78712	0.78703	0.78695	0.78686
23.	0.78678	0.78669	0.78660	0.78652	0.78643	0.78635	0.78626	0.78618	0.78609	0.78600
24.	0.78592	0.78583	0.78575	0.78566	0.78558	0.78549	0.78540	0.78532	0.78523	0.78515
25.	0.78506	0.78497	0.78489	0.78480	0.78472	0.78463	0.78454	0.78446	0.78437	0.78429
26.	0.78420	0.78411	0.78403	0.78394	0.78386	0.78377	0.78368	0.78360	0.78351	0.78343
27.	0.78334	0.78325	0.78317	0.78308	0.78299	0.78291	0.78282	0.78274	0.78265	0.78256
28.	0.78248	0.78239	0.78230	0.78222	0.78213	0.78205	0.78196	0.78187	0.78179	0.78170
29.	0.78161	0.78153	0.78144	0.78136	0.78127	0.78118	0.78110	0.78101	0.78092	0.78084
30.	0.78075	0.78066	0.78058	0.78049	0.78040	0.78032	0.78023	0.78014	0.78006	0.77997

7.8 Percentage

Purpose: This application is used to determine the percentage share or the percentage difference of the sample related to a reference weight.



- ▶ Select the Menu key in any application.



- ▶ Select the **Percentage** symbol in the menu.

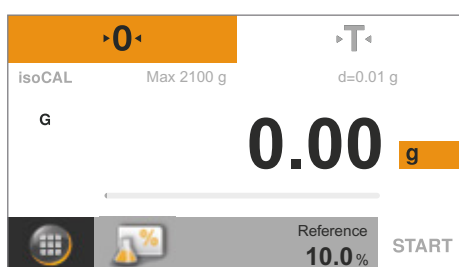

- ▶ The **Percentage** application appears. The reference percentage is displayed under **Reference** (e.g., 10.0%).

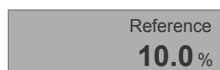

- ▶ To change the reference percentage, select the gray button.

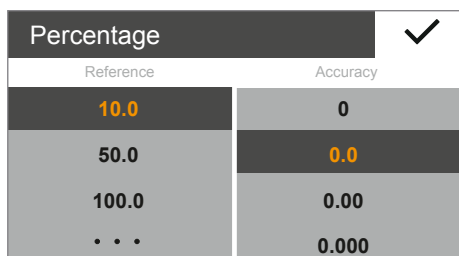

- ▶ The **Percentage** settings window appears.
- ▶ Enter the reference percentage on the left. Select a value or select ..., enter the desired value, and confirm with ✓.
- ▶ Select the accuracy of the percentage display on the right.
- ▶ Select ✓ to confirm.



- ▶ Select **0** to zero the balance if necessary.

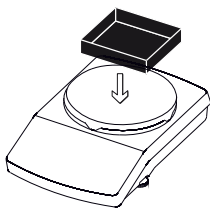

- ▶ Place a container on the weighing pan.



- ▶ Select **T** to tare.

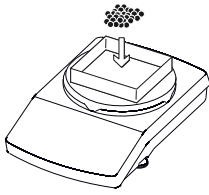

- ▶ Place the reference sample on the weighing pan.

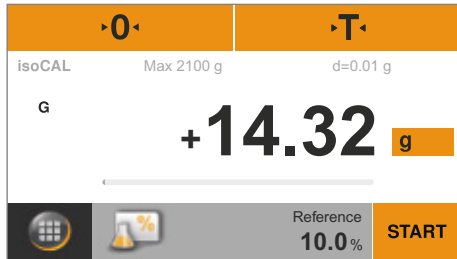

- ▷ The weight of the reference sample is displayed.



- ▶ Select **START**.

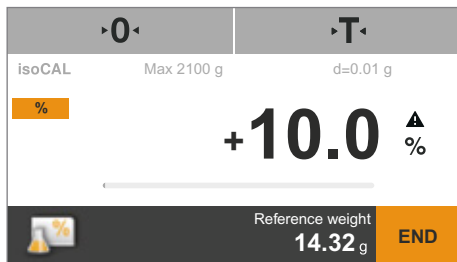

- ▷ The display shows the reference percentage.
The weight of the reference sample is displayed under **Reference weight**.
- ▶ Remove the reference sample from the balance.

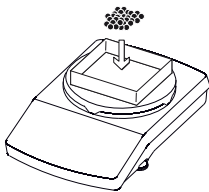

- ▶ Place the unknown sample on the weighing pan.

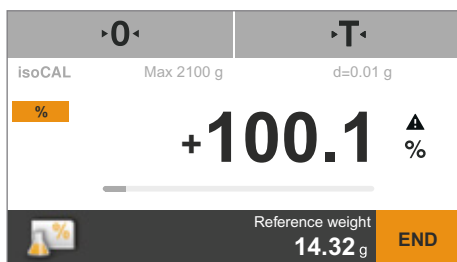

- ▷ The balance shows the percentage of the sample based on the reference sample.

%

▶ To view the sample weight, select the % button on the weighing display.

▷ The weight of the sample is displayed.

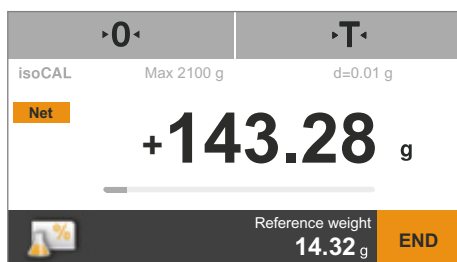
**Net**▶ To change back to viewing the percentage, select the **Net** button again.

▶ Place additional samples on the weighing pan, if any, to calculate their percentages based on the reference sample.

END▶ To exit the function, select **END**.

▷ The application returns to its original state.



There is an online animation for this application. Click here to view it:



7.9 Conversion (Secura® and Quintix® only)

Purpose: Use this application to multiply the weight value by a user-defined factor. Division is also possible if a factor of less than one is selected. The selected factor is saved to protected memory.

Example: You want to calculate the weight per unit of a sheet of paper (DIN A4).

To do so, proceed as follows:

- The weight per unit (e.g., 80 g/m²) can be determined by dividing the weight by the surface.
- The surface of a sheet of DIN A4 paper is:
 $0.210 \times 0.297 = 0.06237 \text{ m}^2$.
- Division by 0.06237 is equal to multiplication by reciprocal value $1 / 0.06237$, i.e., 16.03335.
- Set the factor to 16.03335 in the application.



▶ Select the Menu key in any application.



▶ Select the **Conversion** symbol in the menu.

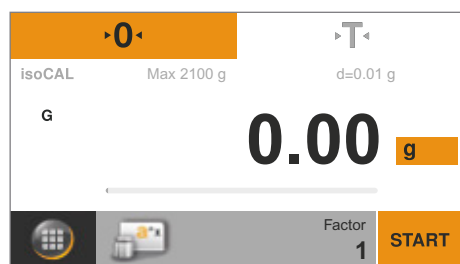

▶ The **Conversion** application appears. The multiplier is displayed under **Factor**.



▶ To set the factor and accuracy of the conversion, select the gray button.

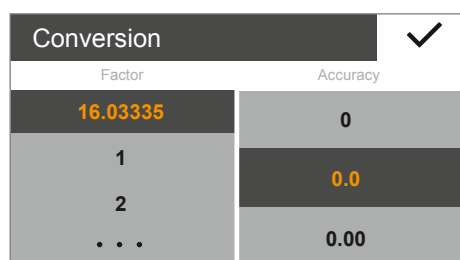

▶ The **Conversion** settings window appears.

▶ On the left, enter the factor by which the weight of the sample will be multiplied. Select a value or select ..., enter the desired value, and confirm with ✓.

▶ Select the accuracy of the conversion display on the right.

▶ Select ✓ to confirm.



▶ Select **0** to zero the balance if necessary.



▶ Select **START**.



- ▶ Place the sample on the weighing pan.

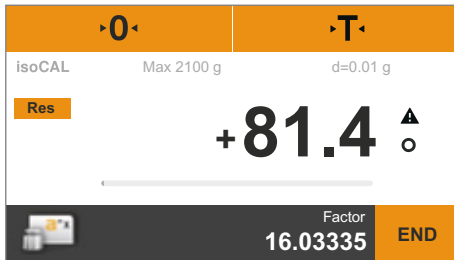

- ▶ The weight of the sample is multiplied by the entered factor, and the result is displayed.

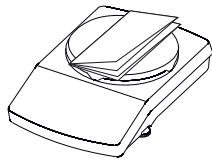

- ▶ Place additional samples on the weighing pan, if any, to multiply their weights by the entered factor.

Res

- ▶ To view the measured individual weight of the sample, select the **Res** button on the weighing display.

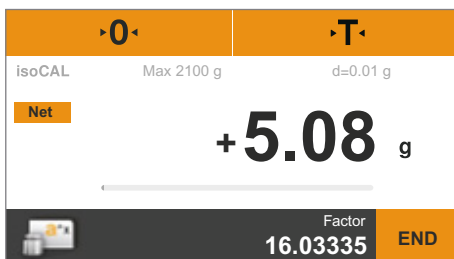

- ▶ The individual weight of the sample is displayed.

Net

- ▶ To switch back to the calculated result, select the Net/G button again.

END

- ▶ To exit the function, select **END**.
- ▶ The application returns to its original state.



There is an online animation for this application. Click here to view it:



7.10 Unstable Condition

Purpose: Use this application with moving samples (such as live animals) and for weighing in unstable environments. A measurement cycle is automatically carried out with a defined number of measurements for each object to be weighed. The individual measurements are averaged, and this average is displayed as the result.



▶ Select the Menu key in any application.



▶ Select the **Unstable condition** symbol in the menu.

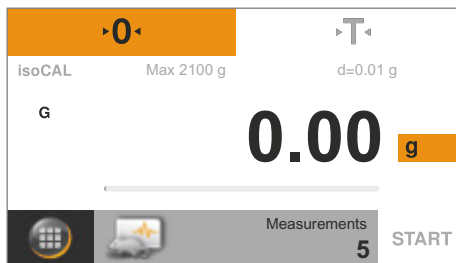

▶ The **Unstable condition** application appears. The set number of measurements is displayed under **Measurements**.

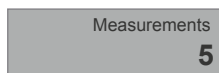

▶ To set the number of measurements and other settings, select the gray button.

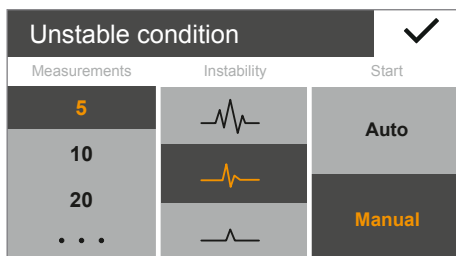

▶ The **Unstable condition** settings window appears.

▶ On the left, enter the number of measurements.

Select the number of measurements on the left or select ..., enter the desired value, and confirm with ✓.

▶ Select the degree of instability of movement in the middle (e.g., for the starting criterion of the measurement).

▶ On the right, choose whether the measurements are started manually with **Manual** or automatically with **Auto**.

▶ Select ✓ to confirm.



▶ Select **0** to zero the balance if necessary.

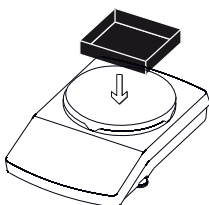

▶ To weigh a living animal, place a container or cage on the weighing pan.



▶ Select **T** to tare.

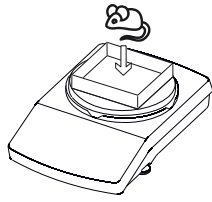

- ▶ Place the animal in the container.

START

- ▶ If the start of measurement is set to **Manual**, select **START**.
If the start of measurement is set to **Auto**, the measurement begins as soon as the individual weight values fall within the preset fluctuation range/instability.

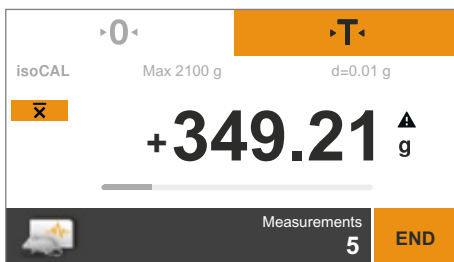

- ▶ The specified number of measurements is carried out.
The average is calculated and displayed.

\bar{x}

- ▶ To view the current weight value, select the \bar{x} button on the weighing display.

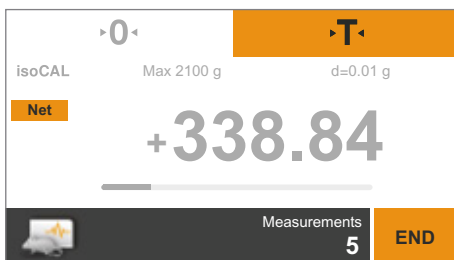

- ▶ The (fluctuating) current weight value is displayed in gray.

Net

- ▶ To change back to viewing the calculated average, select the **Net** button again.

END

- ▶ To exit the function, select **END**

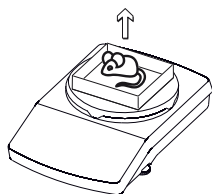

or remove the sample from the weighing pan.

- ▶ The application returns to its original state.



There is an online animation for this application. Click here to view it:



7.11 Checkweighing

Purpose: Use this application to check whether a weight value falls within the specified tolerances. This application also makes it easy to fill sample materials to a specified target weight.



▶ Select the Menu key in any application.



▶ Select the **Checkweighing** symbol in the menu.

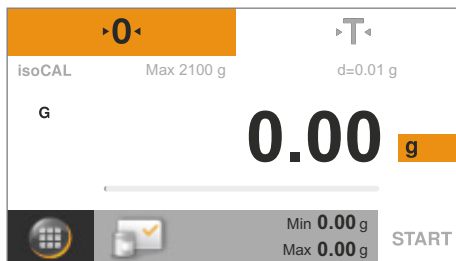

▷ The **Checkweighing** application appears. The set thresholds are displayed under **Min** and **Max**.



▶ To set the thresholds, select the gray button.



▷ The **Checkweighing** settings window appears.

▶ Select or enter the lower threshold (minimum) and the upper threshold (maximum).

Select **...**, enter the desired value, and confirm with **✓**.

▶ Select **✓** to confirm.

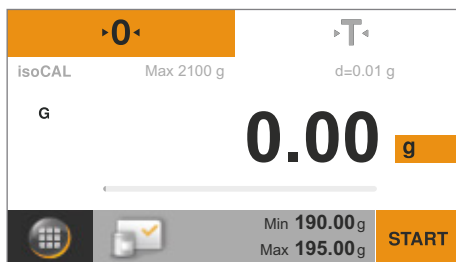

▷ The set thresholds are displayed.



▶ Select **0** to zero the balance if necessary.

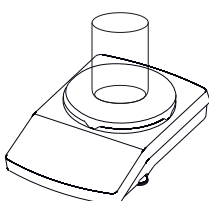

▶ Place a container on the weighing pan.



- ▶ Select **T** to tare.



- ▶ Select **START**.

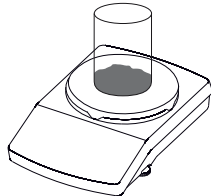

- ▶ Place the sample on the weighing pan.

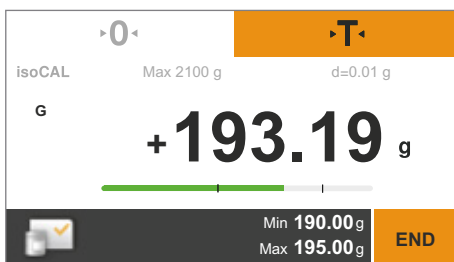

- ▶ The weight value is displayed.
The colored bar indicates whether the weight value falls within the thresholds:
 - Yellow: The weight value is too low.
 - Green: The weight value is OK and falls within the specified range.
 - Red: The weight value is too high.

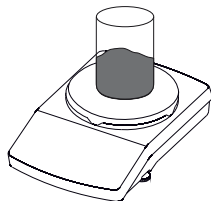

- ▶ Add the sample to the weighing pan until the desired value is reached, or place other samples, if any, on the weighing pan for checkweighing.



- ▶ To exit the function, select **END**.
- ▶ The application returns to its original state.



There is an online animation for this application. Click here to view it:



7.12 Peak Hold

Purpose: Use this application to calculate the maximum weight value of a sample (peak value). The value remains on the display for five seconds after the sample has been removed from the balance.

Example: Use for measuring release force during an experiment, or use when a load is so big that the balance display is hidden from view during weighing.



▶ Select the Menu key in any application.



▶ Select the **Peak hold** symbol in the menu.

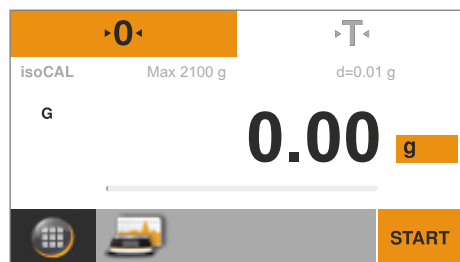

▷ The **Peak hold** application appears.



▶ To define the setting for calculating the peak hold, select the gray button.

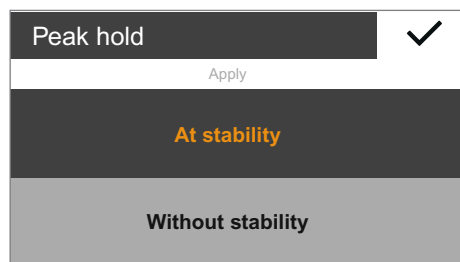

▷ The **Peak hold** settings window appears.

▶ Choose whether the peak hold (max. value) is calculated **At stability** or **Without stability**.

- The **At stability** setting is suitable for stable samples. It ensures that the weight value fluctuations when placing or removing the sample from the balance do not cause the calculated peak value to be incorrect.
- The **Without stability** setting is suitable for unstable samples.

▶ Select ✓ to confirm.



▶ Select **0** to zero the balance if necessary.



▶ Select **START**.

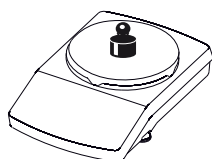

▶ Place the sample on the weighing pan.

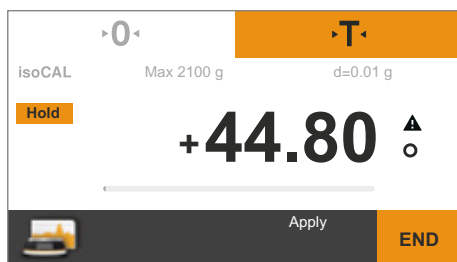

- ▶ The maximum measured weight value is displayed and kept as long as the sample remains on the balance.

Hold

- ▶ To display the current weight value, select the **Hold** button on the weighing display.
- ▶ The current weight value is displayed.

G

- ▶ To change back to viewing the peak hold (max. value), select the **G** or possibly **Net** button again.
- ▶ Remove the sample from the weighing pan.
- ▶ In the "Hold" display mode the balance displays the peak hold (max. value) for another five seconds before switching back to zero.
- ▶ Place additional samples, if any, on the weighing pan.

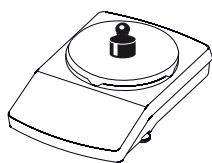

END

- ▶ To exit the function, select **END**.
- ▶ The application returns to its original state.



There is an online animation for this application. Click here to view it:



7.13 Counting

Purpose: Use this application to determine the number of parts of approximately equal weight. The weight of a counted reference sample is calculated and then the objects with an unknown piece count are weighed. The balance displays the number of parts and the piece weight.

Minimize counting errors:

- Ensure that the weight of individual parts is evenly distributed.
- Larger reference piece counts lead to a higher degree of accuracy.
- Switch on Auto Reference Updating.



▶ Select the Menu key in any application.



▶ Select the **Counting** symbol in the menu.

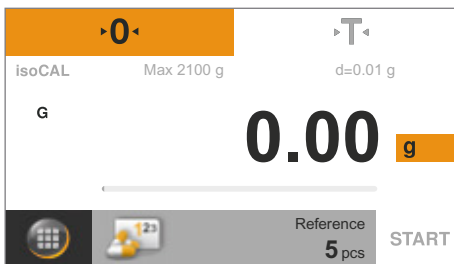

▶ The **Counting** application appears. The piece count of the reference sample is displayed under **Reference**.

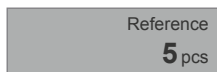

▶ To set the reference sample quantity, select the gray button.

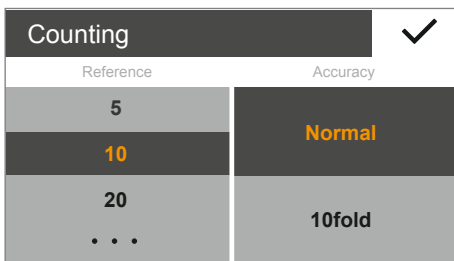

▶ The **Counting** settings window appears.

▶ Enter the reference piece count on the left.

Select a value or select ..., enter the desired value, and confirm with ✓.

▶ Select the accuracy of the weight value during counting in the center.

▶ Activate "Automatic Reference Sample Updating" on the right.

This "updating" optimizes the counting accuracy. The average piece weight is recalculated every time the reference sample is updated automatically. Since the new parts enlarge the basis for the calculation, this increases the counting accuracy of the reference and with it the result too.

▶ Select ✓ to confirm.



▶ Select **0** to zero the balance if necessary.

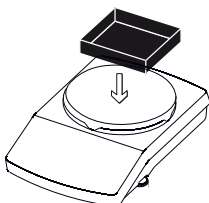

▶ Place a container on the weighing pan.



- ▶ Select **T** to tare.

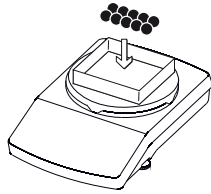

- ▶ Place the set number of reference samples on the weighing pan.

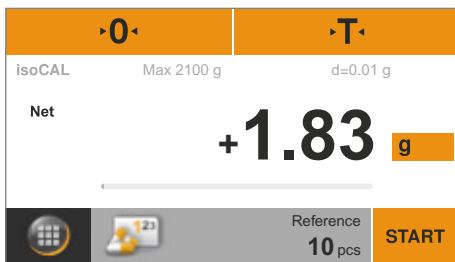

- ▶ The weight value is displayed.



- ▶ Select **START**.

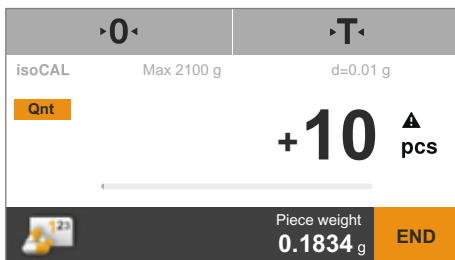

- ▶ The weighing displays changes and shows the piece count. The average piece weight is shown on the weighing display. "Update automatically" setting:
- ▶ If the balance is performing the automatic reference sample update, "Update" will display the new average piece weight.

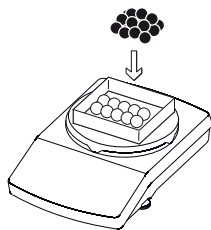

- ▶ Place the sample with the unknown piece count on the weighing pan.

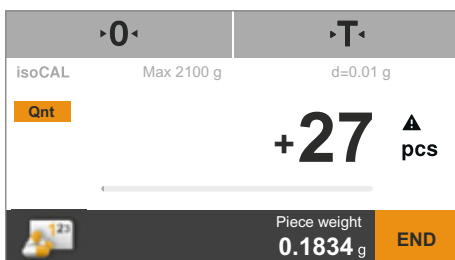

- ▶ The piece count is calculated and displayed.
- ▶ Place other pieces, if any, on the balance to reach a specific desired count.

Qnt

▶ To view the total weight of the sample, select the **Qnt** button on the weighing display.

▷ The total weight of the sample is displayed.

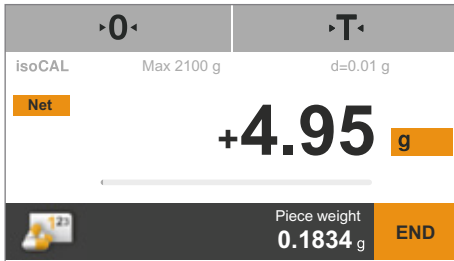
**Net**

▶ To change back to viewing the piece count, select the **Net** button again.

END

▶ To exit the function, select **END**.
▷ The application returns to its original state.



There is an online animation for this application. Click here to view it:



8. Calibration and Adjustment

Background During **calibration**, a calibration weight is used to determine how much the displayed value deviates from the actual measurement value. This deviation is compared against a preset target value. The subsequent **adjustment** corrects this deviation or reduces the permissible error limits.
In Secura®, Quintix® and Practum® balances, calibration and adjustment are combined as one process. The balance is automatically adjusted after each calibration.

M

Before using a verified balance for legal metrology, calibration/adjustment must always be carried out at the balance setup location. This can be performed automatically or manually, or for Practum® models of accuracy class **I** using an external weight.

When and How Often To achieve the highest accuracy possible, regularly calibrate and adjust the balance:

- daily after switching on the balance,
- each time the balance is leveled,
- each time ambient conditions have changed (temperature, humidity, or air pressure),
- each time the balance is set up at a new location or moved in its current location.

The following describes in detail the available options for calibrating and adjusting the balance:

- Calibration/adjustment using an internal calibration weight (Secura® and Quintix® only)
- Calibration/adjustment using an external calibration weight (see "Calibration/Adjustment Using an External Calibration Weight" on page 75)
- Automatic calibration/adjustment with isoCAL

8.1 Calibration/Adjustment Using an Internal Calibration Weight (Secura® and Quintix® only)

The balance is fitted with an internal calibration weight in the housing. This calibration weight is automatically placed on the balance by a motor during internal calibration and adjustment.

- ▶ Ensure that the balance is stable, the draft shield is closed (if applicable) and the weighing pan is empty.



- ▶ Select **0** to zero the balance.



- ▶ Select the menu key at the bottom left of the display in the current application.

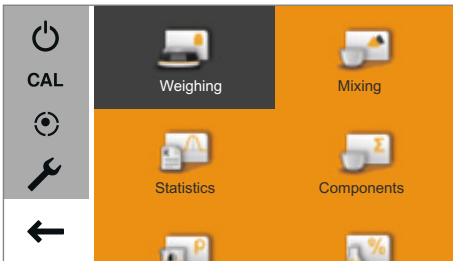

- ▶ The menu appears.



- ▶ Select the CAL button to access the calibration function.

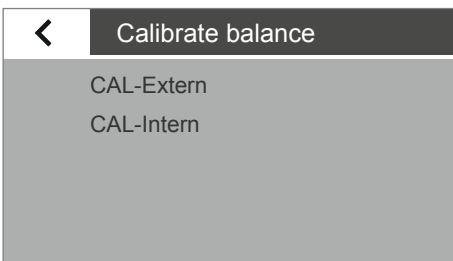

- ▶ The **Calibrate balance** window appears.

- ▶ Select **CAL-Intern**.

- ▶ Calibration begins.
 - The internal weight is automatically placed on the balance in the housing.
 - The balance is calibrated and then immediately adjusted.
 - The internal weight is automatically removed from the balance.

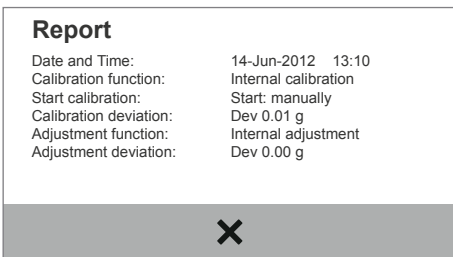

- ▶ A report appears on the display. The report indicates the deviations identified during calibration. The report also gives the result of the adjustment process.

- ▶ Close the report window: Select **X**.

- ▶ The balance is now calibrated and adjusted.



Information on potential errors can be found in the "Status Messages" chapter on page 91.

8.2 Calibration/Adjustment Using an External Calibration Weight



An external calibration weight is required for this function. Please note the tolerance of the calibration weight being used.



In verified balances with accuracy class II external calibration/adjustment is blocked in legal metrology. Secura® and Quintix® In verified balances with accuracy class I , external adjustment can only be accessed when the access switch is open.

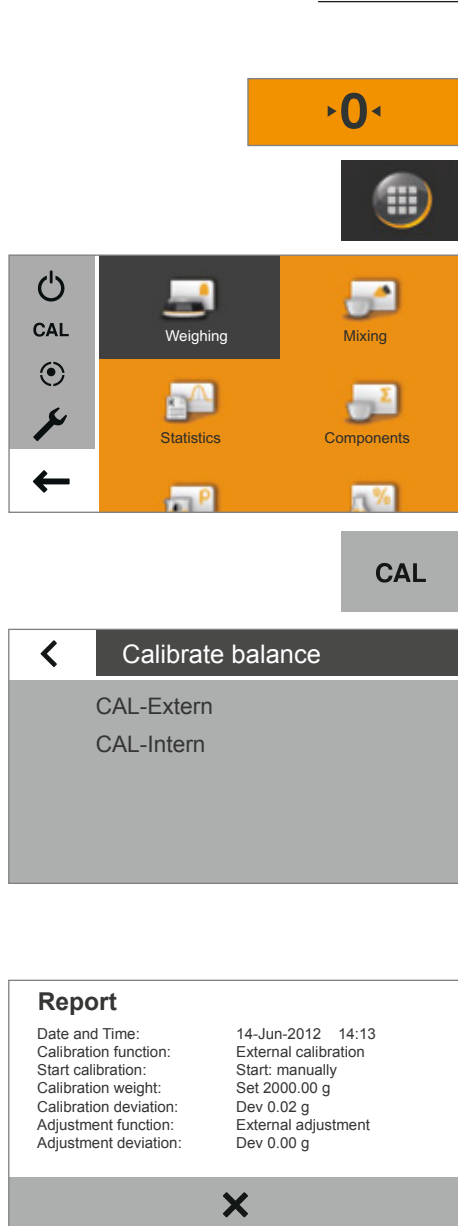

- ▶ Make sure that the weighing pan is empty.
- ▶ Select **0** to zero the balance.
- ▶ Select the menu key at the bottom left of the display in the current application.
- ▶ The menu appears.
- ▶ Select the CAL button to access the calibration function.
- ▶ The **Calibrate balance** window appears.
- ▶ Select **CAL-Extern**.
- ▶ Practum® models: Calibration values appear on the display.
- ▶ Select the value of your calibration weight.
- ▶ A message appears on the display, prompting the user to place the calibration weight on the weighing pan.
- ▶ Place the calibration weight on the weighing pan.
- ▶ Calibration starts automatically.
- ▶ A report appears on the display (Secura® and Quintix® only). The report indicates the deviations identified during calibration. The report also gives the result of the adjustment process.
- ▶ Close the report window: Select **X**.
- ▶ The balance is now calibrated and adjusted.



Information on potential errors can be found in the "Status Messages" chapter on page 91.

8.3 Automatic Calibration/Adjustment with isoCAL

Fully automatic calibration/adjustment ensures that the balance is automatically calibrated and adjusted when predefined time intervals or temperature values are exceeded.

This function varies in different models:

- Secura® / Quintix®: isoCAL is automatically carried out based on time or temperature, and each time the balance is leveled. This function can be switched off via the system settings (see page 31).



In Secura® models, every adjustment process, including the identified deviations, is documented and saved on the balance. The saved reports can be viewed via the system settings and printed out on a PC or Sartorius lab printer (see page 31).

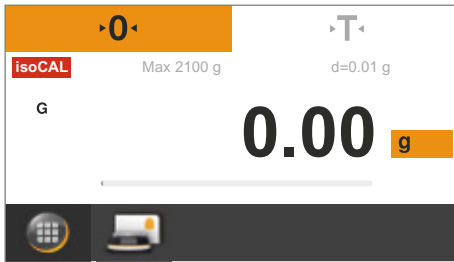

- ▷ If the ambient temperature has changed since the last calibration/adjustment or the preset time interval has been exceeded, the red **isoCAL** button appears on the display.

- ▷ If the **isoCAL** function is set to Automatic, the calibration/adjustment process starts automatically.
- ⚠ If the balance has not been adjusted, the prompt will be shown again 5 minutes after the "isoCAL" status message is acknowledged.

- ▷ If the **isoCAL** function is set to **Info, manual start**, the function must be started manually.

isoCAL

- ▶ To start the calibration/adjustment function manually, select the **isoCAL** button (Secura®, Quintix®).

- ▷ Calibration starts automatically.

- ▷ A report appears on the display (Secura® and Quintix® only). The report indicates the deviations identified during isoCAL calibration. The report also gives the result of the adjustment process.

- ▶ Close the report window: Select **x**.

- ▷ The balance is now calibrated and adjusted.

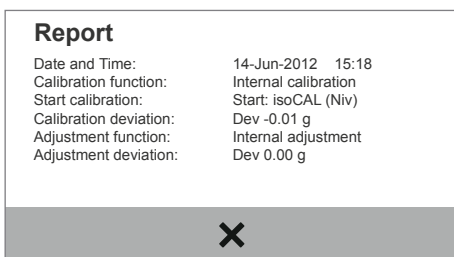

9. ISO/GLP-compliant Printout

9.3.1 Characteristics

The device information, ID, and the current date can be printed before (GLP header) and after (GLP footer) the values from the weighing series.

The following data is printed out:

GLP Header:

- Date/time at the start of a weighing series
- Balance manufacturer
- Balance model
- Model serial number
- Balance software version number (BAC)
- Display software version number (APC)
- Two identification numbers (ID and A ID) with max. 14 characters (ASCII)
- Device and batch ID with max. 14 characters (if activated in the system settings)

GLP Footer:

- Date
- Time at the end of a weighing series
- Field for signature

9.3.2 Configuration



To print the ISO/GLP printout, define the following system settings (see "Printout" on page 34):

- ▶ Activate ISO/GLP-compliant printouts:
Go to the **Printout** menu, select "Manual with stability," and then under **Manual print** set the **ISO/GLP printout** option to **On**.
- ▶ Set printout format of date and time:
Go to the **Printout** menu and then under **Manual print** select **Manual print format**. Select any setting except "Value w/o identifier."



- The ISO/GLP printout is not printed if "Value w/o identifier" is set when connecting to a PC.
- The ISO/GLP printout is only printed if the "Manual with stability" setting is selected under Printout.
The "Value w/o identifier" menu option is only displayed if data is being output to a PC.

9.3.3 Operation

- ▶ To print the header and the first measurement value: Select the  button.
- ▶ To print the header and start an application: Select the **START** button.
- ▶ The header is included with the first printout.
- ▶ To print the results of the application and the footer: Select the **END** button.
- ▶ To print the footer: Select the  button.

- ▷ The ISO/GLP printout can have the following lines (configuration using date/time "DD-MMM-YYYY" and "12h AM/PM"):

```

-----
09-Nov-2013 02:50 pm
  Sartorius
Mod.      Secura 5101
SerNo.    0027400115
BAC:      00-51-01
APC:      01-70-02
ID        Device 1234
A ID      Inv.-Nr. 11
-----
L ID      CH01
09-Nov-2013 02:50 pm
S ID      Tablette 4321
N +       10.9 g
T +       ≤5.6 g
G#        + 16.5 g
-----
09-Nov-2013 02:50 pm
Name:
-----

```

- ▷ A sample ISO/GLP printout for external calibration/adjustment can be seen below (configuration using ISO date/time):

```

-----
2013-11-23      14:57
  Sartorius
Mod.      Secura 5101
SerNo.    0027400115
BAC:      00-51-02
APC:      01-70-02
ID        Device 1234
A ID      Inv.-Nr. 11
-----
2013-11-23      14:57
External calibration
Start:      manually
Set +       5000.0 g
Dev +       3.0 g
External adjustment
Dev         0.0 g
-----
2013-11-23      14:57
Name:
-----

```

10. USB Port

10.1 Communication with Peripheral Devices

Purpose: The interface is used to exchange data with connected peripheral devices: Measured values and calculated values can be output to a printer, PC, or second display; conversely, control commands and data inputs can be sent via connected devices (e.g., PC). The protocols SBI and xBPI can be transmitted via the USB port.

The following connections can be established with peripheral devices:

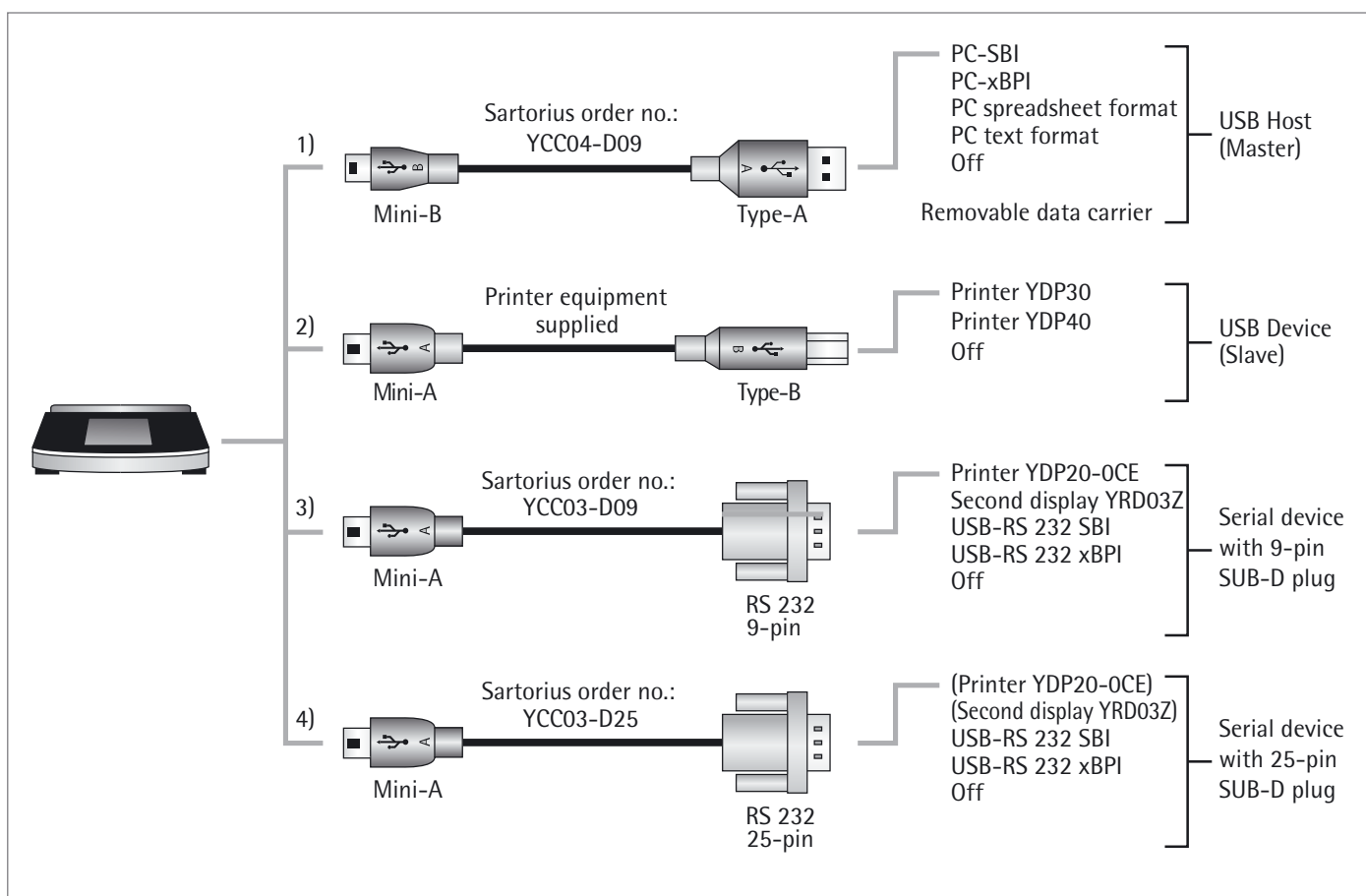

10.2 Direct Transfer of Data (PC)

Requirements:

- PC with Windows 7, Vista, Windows XP, or 2000 operating system
- A to Mini-B USB connection cable from PC to balance, Sartorius order no. YCC04-D09



In legal metrology, data can be transmitted to a PC and used with an Alibi memory. The balance does not have its own Alibi memory. Connection to a printer or Alibi printer is permitted.

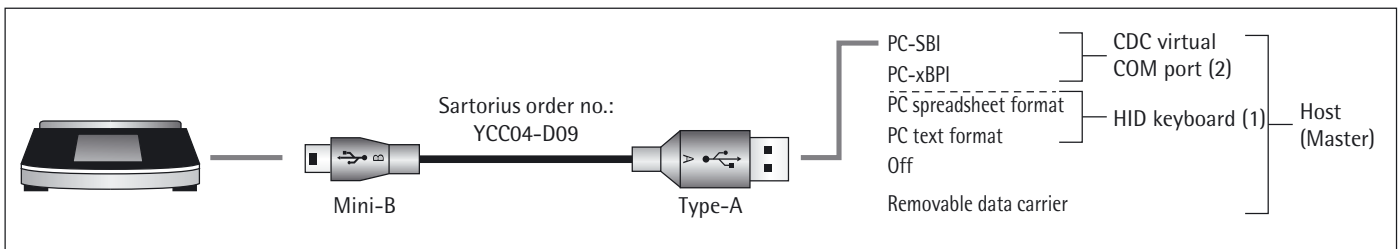

(1) USB Connection as PC Keyboard without Additional Driver via a PC with Spreadsheet or Text Editor (e.g., Microsoft Office or OpenOffice)

- ▶ Connect the balance to the PC using the supplied USB connection cable.



- ▶ To access the system settings of the balance, select (Setup) in the menu.

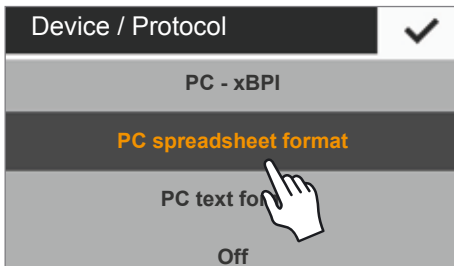

- ▶ To access the **PC spreadsheet format** menu option on the balance: Go to **USB port** and select the **Device/Protocol** option.

Setting Options

- ▶ If you need to adjust the balance to match the settings on your PC, you can implement the following system settings:
 - For the spreadsheet, the decimal place and output format: See "System Settings" on page 36.
 - Emulation of the PC keyboard for English (USA) instead of Universal (Num Lock on): See "System Settings" on page 36.

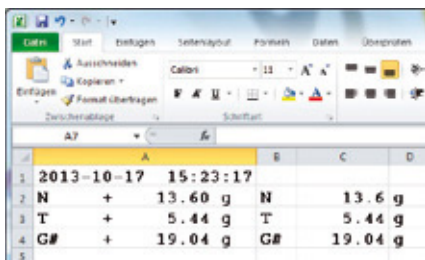

2013-10-17	15:23:17		
N	+	13.60 g	N 13.6 g
T	+	5.44 g	T 5.44 g
G#	+	19.04 g	G# 19.04 g

- ▶ With the "PC spreadsheet format" setting on the balance, **Microsoft Excel 2010** has the following display for the "Gross/Tare/Net" example:

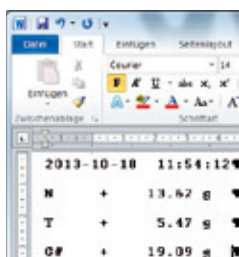

2013-10-10	11:54:12		
N	+	13.62 g	
T	+	5.47 g	
G#	+	19.09 g	

- ▶ With the "PC text format" setting on the balance, **Microsoft Word 2010** has the following display for the "Gross/Tare/Net" example:

Additional Data Transmission Settings on the PC (Keyboard Set to EN (USA))

To ensure that the data is imported correctly from the balance using the spreadsheet or text program, the Office program installed on your PC needs to be configured.

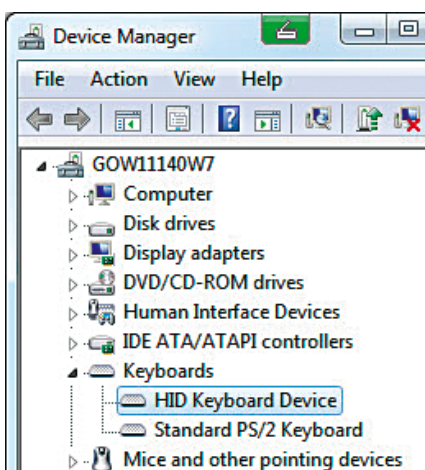

- ▶ Function test:
 - The **HID keyboard** connection appears in the Device Manager of the PC under **Connections – Keyboards**.



- ▶ Set the language to English (USA) – U.S. in the language toolbar of the PC (e.g. in the taskbar).
Note: If English (UK) is chosen, "G£" is printed instead of "G#."

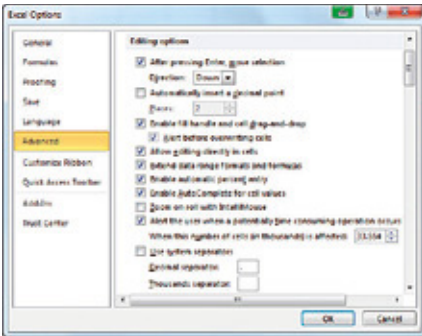

- ▶ Configure how Microsoft Excel treats numbers:
In Excel, go to **File – Options – Advanced – Editing options** and set the following separators:
 - Decimal separator: Period
 - Thousand separator: Empty (none)

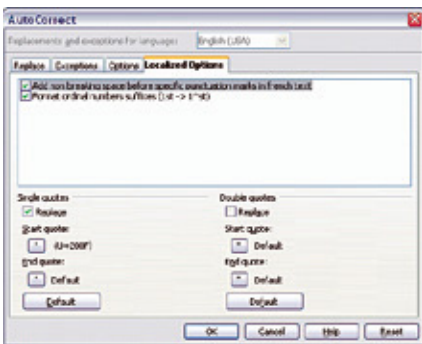

- ▶ Configure the typographical quotation marks for OpenOffice Calc:
In Calc, go to **Tools – Autocorrect Options – Custom Quotes** and set the following "Simple quotes":
 - At the beginning of a word: empty space (U+200F)
 - At the end of a word: " ' "

▷ The following displays appear after data is transferred to the PC:

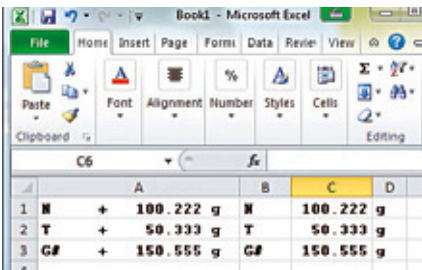

- Microsoft Excel 2010 (example): Gross/Tare/Net

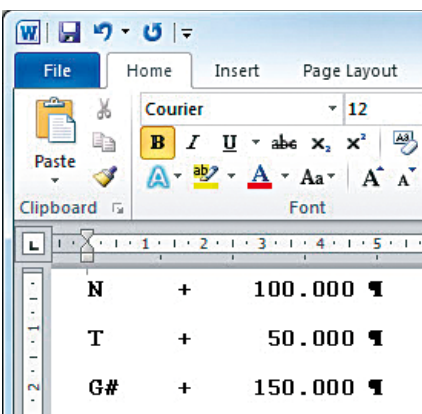

- **PC text format** set on balance and Microsoft Word 2010 (example):
Gross/Tare/Net

(2) USB Connection: PC-SBI and PC-xBPI Operating Mode

To use the balance as a slave device for the protocols PC-SBI and PC-xBPI, first install a USB driver on the connected PC. This driver can be located in the "Driver" folder on the balance. The balance is then operated via a virtual, serial interface (COM port).

Installing the USB Driver



The USB driver for the virtual, serial interface is Microsoft-listed and available online via the Microsoft Update Service.

A USB driver does not need to be installed if the PC is connected to a network and has administrator rights (authorization to install updates). The driver is installed automatically on the PC in this case when the balance is connected to the PC.

If the PC is not connected to a network, the following information must be taken into account:

- ▶ Connect the balance to the PC using the supplied USB connection cable.
- ▶ To access the system settings of the balance, select  (Setup) in the menu.
- ▶ To access the **USB mass storage** menu option on the balance: Go to **More settings** and select the **USB mass storage** option.

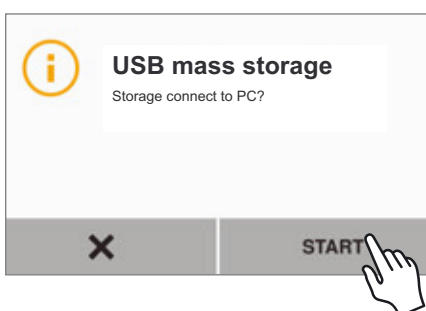
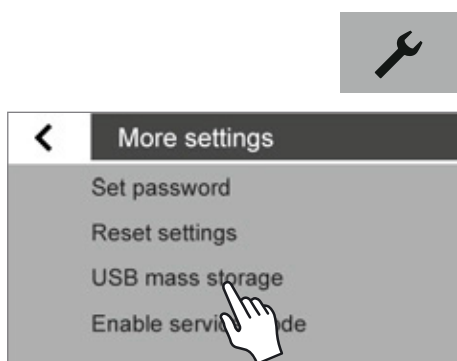

- ▶ To connect the balance memory to the PC: Select **Start**.

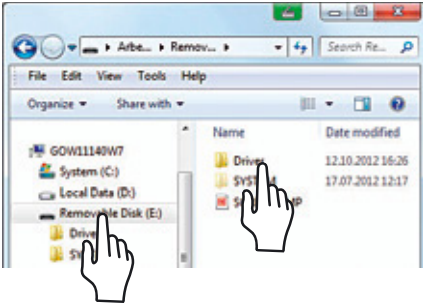

- ▶ To install the installation program for the USB driver on the PC:
Click on the appropriate removable data carrier (in this case, the E: drive) and then click on the **Driver** folder.

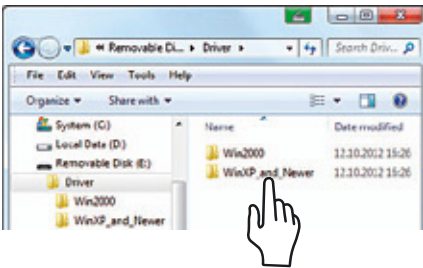

- ▶ To select the Windows version:
Click on the appropriate version of the PC.

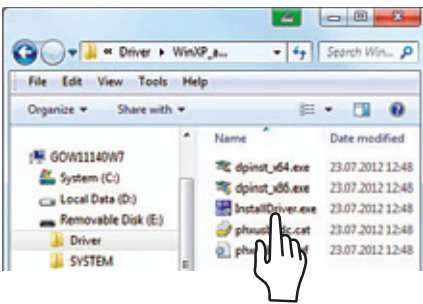

- ▶ Start the installation program **InstallDriver.exe**.

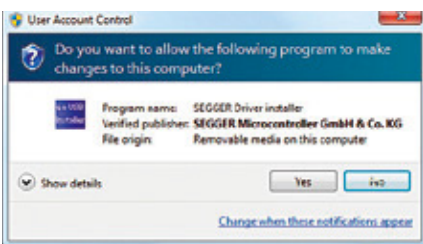

- ▶ Follow the instructions from the installation program.

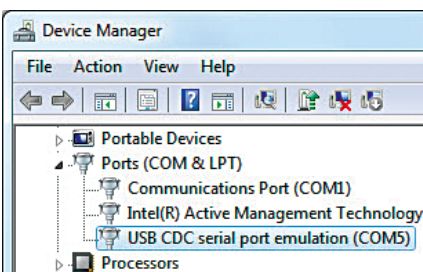

- ▷ Function test:
 - Once the driver is installed, operating modes PC-SBI and PC-xBPI are available.
 - The **USB CDC serial port emulation** connection appears in the Device Manager of your PC under **Connections**.



Note: This does not apply to operating modes "PC spreadsheet format", "PC text format" and "Off".

The data transfer commands can be found in the "Data Input Format" chapter.

Connecting with Sartorius Lab Printer YDP30, YDP40

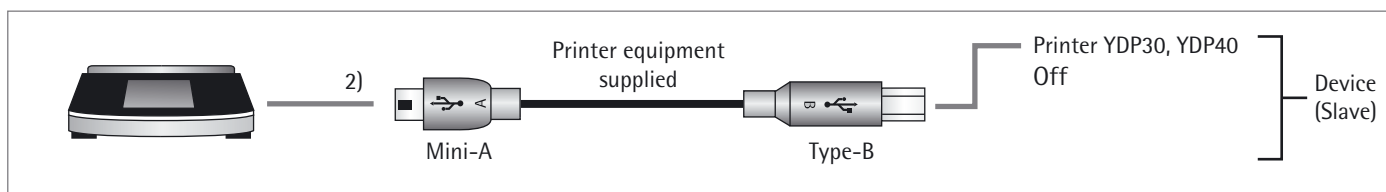

- ▶ Connect the balance to the Sartorius printer using the supplied USB connection cable.
- ▷ The balance detects the printer automatically. No settings need to be changed.

Connections for RS-232 Configuration "9-Pin"

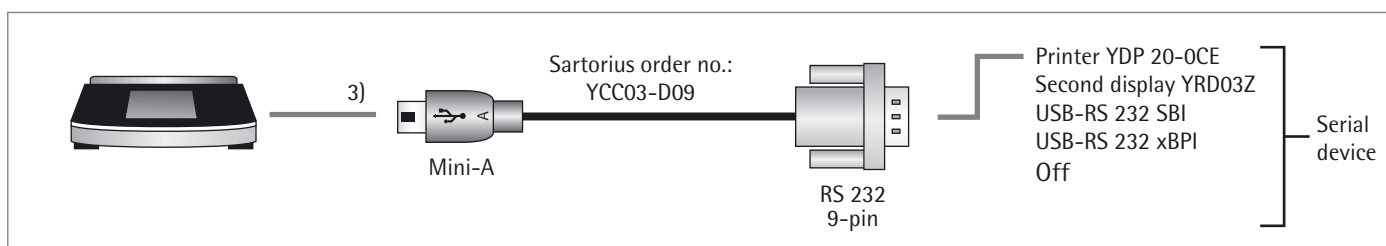

- ▶ Connect the peripheral device to the balance via Sartorius connection cable YCC03-D09 (RS-232, 9-pin, assigned as per PC).
- ▶ Define the desired system settings:
See "USB Port" on page 36.

Connections for RS-232 Configuration "25-pin"

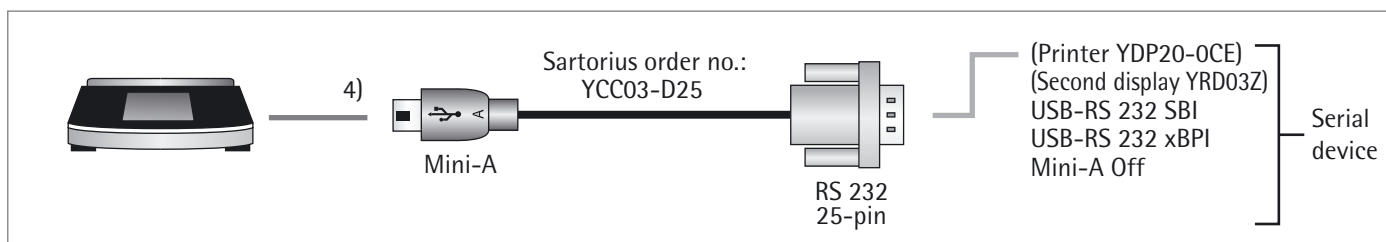

- ▶ Use Sartorius connection cable YCC03-D25 (RS-232, 25-pin, Sartorius-specific assignment) to connect the peripheral device to the balance.
- ▶ Implement the required system settings:
See "USB Port" on page 36.

10.3 Interface Specification

10.3.1 Data Output

You can define the data output parameter so that output is activated either when a manual print command is received or automatically synchronized with the display or at defined intervals (see application programs and autoprnt settings).

Data Output following Print Command The print command can be transmitted by pressing the  key or by software command (Esc P).

Automatic Data Output In **Autoprnt** mode, data is output to the data interface port without an extra print command. You can have synchronized data output automatically or at defined intervals, with or without balance stability. If the automatic data output is activated in the Device Configuration, it starts immediately after the balance is turned on.

10.3.2 Data Output Formats

You can output the values with or without an identifier. The output format is configured in the device settings (see page 34).

Example: Output without ID **+ 253 p c s** (16 characters are printed, "SBI" mode only)

Example: Output with ID **Q n t + 253 p c s** (22 characters are printed, always with ID for printers and "PC text format")

Data Output Format with 16 Characters

Characters that are blank on the display are printed as spaces.

Display values without a decimal point are printed without a decimal point.

Normal Operation

Position	1	2	3	4	5	6	7	8	9	10	11	12	13	14	15	16
	+	A	A	A	A	A	A	A	A	A	*	E	E	E	CR	LF
or	-	-		*	*	*		
or	*	*	*	*	*	*	*	*	*	*						

* Space
 A Displayed characters
 E Unit of measure characters
 CR Carriage return
 LF Line feed
 . Decimal point or comma

Special Outputs

Position	1	2	3	4	5	6	7	8	9	10	11	12	13	14	15	16
	*	*	*	*	*	*	-	-	*	*	*	*	*	*	CR	LF
or	*	*	*	*	*	*	L	o	w	*	*	*	*	*	CR	LF
or	*	*	*	*	*	*	H	i	g	h	*	*	*	*	CR	LF

*	Space	Cal.Ext.	External adjustment
- -	Final readout	Cal.Int.	Internal adjustment
Low	Underweight	CR	Carriage return
High	Overload	LF	Line feed

Error message

Position	1	2	3	4	5	6	7	8	9	10	11	12	13	14	15	16
	*	*	*	E	r	r	*	*/#	#	#	*	*	*	*	CR	LF

*	Space	###	Error number
---	-------	-----	--------------

Example: Output of the weight value + 111.255 g

Position	1	2	3	4	5	6	7	8	9	10	11	12	13	14	15	16
	*	*	*	1	1	1	.	2	5	5	*	g	*	*	CR	LF
	+	*	*	1	2	3	.	5	[6] ¹⁾	g	*	*	CR	LF

Position 1:	Plus +, minus -, or space
Position 2 – 10:	Space or weight value with decimal point; leading zeros are output as spaces.
Position 11:	Space
Position 12 – 14:	Characters for unit of measure or space
Position 15:	Carriage return
Position 16:	Line feed

¹⁾ Settings "PC – SBI" and "USB RS232 SBI" for the identification of digits not verified for use in legal metrology:

In the setting "SBI", there is no automatic identification of display digits not verified for use in legal metrology. Corresponding measures or settings must be carried out on the peripheral device.

10.3.3 Data Output Format with 22 Characters

When data is output in this format, ID codes with six characters will precede data. These characters identify the subsequent value.

Normal Operation

1	2	3	4	5	6	7	8	9	10	11	12	13	14	15	16	17	18	19	20	21	22
K	K	K	K	K	K	+	A	A	A	A	A	A	A	A	A	*	E	E	E	CR	LF
*	*	*	*	*	*	-	*	*	*	*		
						*	*	*	*	*	*	*	*	*	*	*					

K ID code characters
 * Space
 A Displayed characters
 CR Carriage return
 LF Line feed
 E Symbol for unit
 (see "Conversion Factors for Weight Units" on page 43)

Example:

1	2	3	4	5	6	7	8	9	10	11	12	13	14	15	16	17	18	19	20	21	22	
N						+				1	2	3	.	5	6	*	g	*	*	CR	LF	
N						+				1	2	3	.	5	[6] ¹⁾	g	*	*	CR	LF

Special Outputs

1	2	3	4	5	6	7	8	9	10	11	12	13	14	15	16	17	18	19	20	21	22
S	t	a	t	*	*	*	*	*	*	*	*	-	-	*	*	*	*	*	*	CR	LF
											H	i	g	h							
											L	o	w								
											C	a	l	.	E	x	t	.			

* Space
 Low Underweight
 High Overload
 Cal.Ext. External adjustment
 Cal.Int. Internal adjustment
 CR Carriage return
 LF Line feed

Error Messages

1	2	3	4	5	6	7	8	9	10	11	12	13	14	15	16	17	18	19	20	21	22
S	t	a	t	*	*	*	*	*	E	r	r	*	#	#	#	*	*	*	*	CR	LF

* Space
 ### Error code number

¹⁾ Settings "PC - SBI" and "USB RS232 SBI" for ID of non-verified digits:
 In the "SBI" setting, the non-verified display digit is not automatically identified.
 Please implement the corresponding measures or adjust the settings on the peripheral device.

10.3.4 Data Input

Interface Commands (Commands)

The computer connected via the data interface can send control commands to the balance to control its functions.

Formats for Control Commands (Syntax)

Format 1 Esc ! CR LF

Format 2 Esc ! # _ CR LF

Esc Escape
 ! Command character
 # Number
 _ Underscore (ASCII: 95)
 CR Carriage return (optional)
 LF Line feed (optional)

Examples:

Format 1: Esc P

Format 2: Esc x1_

10.3.5 Overview of Interface Commands (Commands)

Format	Command	Action/Function	Comments
1	ESC P	Print	Corresp. to menu, with/ without stability
1	ESC T	Tare or zero	
1	ESC K	Filter "Very stable conditions"	
1	ESC L	Filter "Stable conditions"	Corresp. to menu setting "stable"
1	ESC M	Filter "Unstable conditions"	Corresp. to menu setting "unstable"
1	ESC N	Filter "Very unstable conditions"	
1	ESC O	Lock keys	
1	ESC Q	Acoustic signal	
1	ESC R	Unlock keys	
1	ESC S	Restart	
1	ESC Z	Internal calibration/adjustment	Depending on menu and model
1	ESC U	Tare	
1	ESC V	Zero	
1	ESC W	Ext. adjustment with standard weight (not available for verified models)	Depending on menu
2	ESC kP_	Print as with Print button	
2	ESC s3_	Go back, exit, cancel	
2	ESC x1_	Print balance type	
2	ESC x2_	Print serial number	
2	ESC x3_	Print balance software version	
2	ESC x4_	Print software version of display and control unit	
2	ESC x5_	Print user/device ID	

11. Status Messages



Messages appear on the display when certain events occur:

- Info messages are displayed for two seconds. The program then returns automatically to its original state.
- Error messages are displayed until they are acknowledged with a key.

11.1 Key Fadeout

To avoid operating errors, only the available functions/keys according to the weighing situation are shown.

The following buttons are only available in certain situations:

0	Only when there is a weight value within the zero setting range.
T	Only when there is a weight value larger than zero, i.e., positive.
	Only when a peripheral device is connected and "Print" is not locked.
CAL	Only when calibration and adjustment functions are available and not locked.
LEVEL	Only when the balance has an electronic level indicator.
	Only when a weight value larger than zero is the value saved in the memory, if the value can be saved (e.g., value larger than SQmin).
START	Only when an application can be started (i.e., only when larger than zero and "Start" is permitted).
E-Check	Some models are equipped with an internal self-test that is regularly carried out. This ensures that all metrological thresholds are maintained.

11.2 Error Messages in Applications

"Value is too small!"	when an entered value is too low for the parameter.
"Value is too large!"	when an entered value is too high for the parameter.
"Incorrect licence code"	when password protection is enabled and the code was entered incorrectly.
"Not able to increase identifier."	when the sample ID could not be assigned a number in ascending order automatically (as described in the "Individual Identifiers" chapter).
"Not able to decrease identifier."	when the sample ID could not be assigned a number in descending order automatically (as described in the "Individual Identifiers" chapter).

Calibration/Adjustment Error Messages

"The balance needs to perform eCheck!"	when eCheck is required.
"The balance needs to be adjusted!"	when isoCAL is required.
"The balance needs to be leveled!"	when leveling is required.
"Weight is too light!"	when a weight that is too light is placed on the balance during external calibration.
"Weight is too heavy!"	when a weight that is too heavy is placed on the balance during external calibration.

Leveling Error Messages

"Leveling"	The balance must be leveled (for balances with electronic level indicators only).
------------	---

Balance Maintenance Error Messages

"Maintenance interval ended"	when the maintenance date set by Service has passed.
------------------------------	--

Calibration Report Error Messages

Cal. data not saved	if the 99 data records per day limit has been reached
"Unable to read file"	if an error occurred when the file was being read

"USB Devices" Error Message

"The attached USB device is not supported."	if a USB device (printer) not made by Sartorius is connected
---	--

12. Transporting the Balance

Please use the original packaging for shipping. Packaging can be ordered through the Sartorius Service Center if required.



Avoid glass breakage, shocks, and vibrations:
Never lift or carry the balance when holding it by its draft shield!



Prior to shipping, switch the balance to standby mode (see page 96) and then pull the plug.

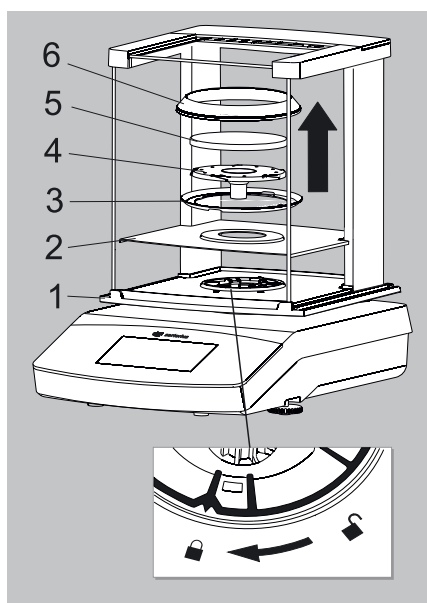

Secura® Models: Balance with Draft Shield

- ▶ Remove the following parts from the balance:
 - Draft ring (1) for models with readability of 0.1 mg
 - Weighing pan (2)
 - Pan support (3)
 - Centering ring (4) for models with readability of 0.1 mg
 - Shield disk (5)
 - Remove glass panels from the draft shield (6):
See next chapter, "Care and Maintenance."

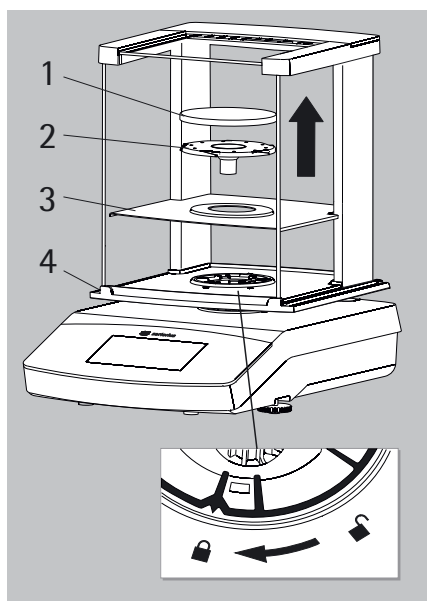

Quintix® and Practum® Models:

- ▶ Remove the following parts from the balance:
 - Weighing pan (1)
 - Pan support (2)
 - Shield disk (3)
 - Remove glass panels from the draft shield (4):
See next chapter, "Care and Maintenance."

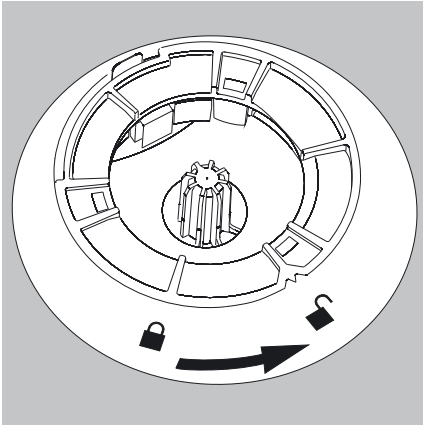

- ▶ Turn the draft shield lock to "unlocked."
- ▶ Next, remove the draft shield from the balance.

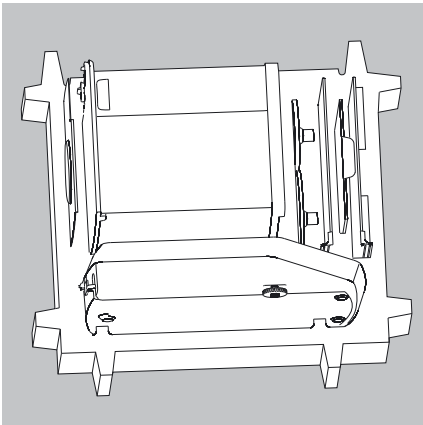

- ▶ Insert the bottom part of the packaging into the box.
- ▶ Place the following parts into the bottom part of the packaging:
 - Draft shield
 - Balance
 - Base plate
 - Side panels
 - Top glass cover

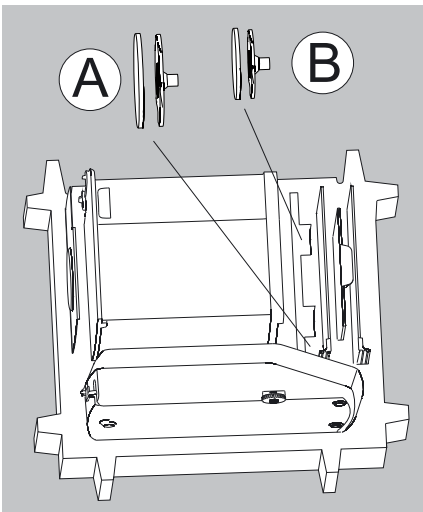

- ▶ Insert the respective weighing pan and pan support into the opening shown in the image to the left:
 - A = Weighing pan and pan support with a diameter of 120 mm
 - B = Weighing pan and pan support with a diameter of 90 mm

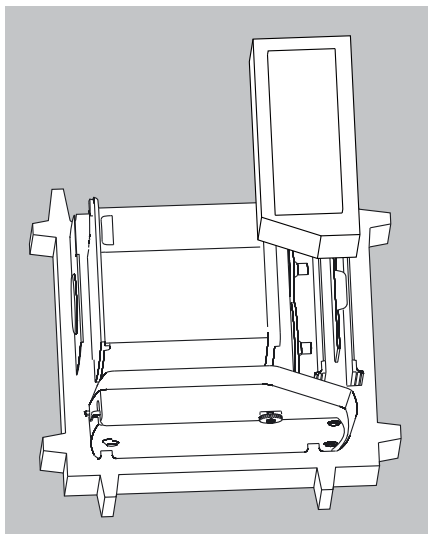

- ▶ Put packing pads over the glass panels.

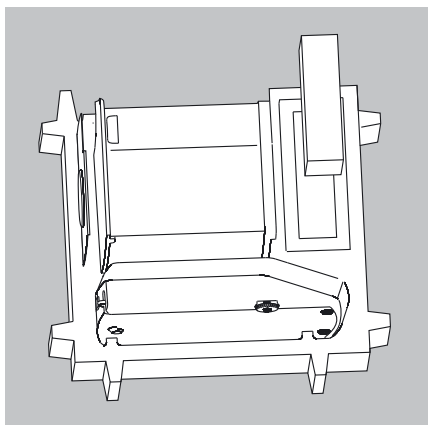

- ▶ Insert the AC adaptor from the cardboard box into the packing pad.

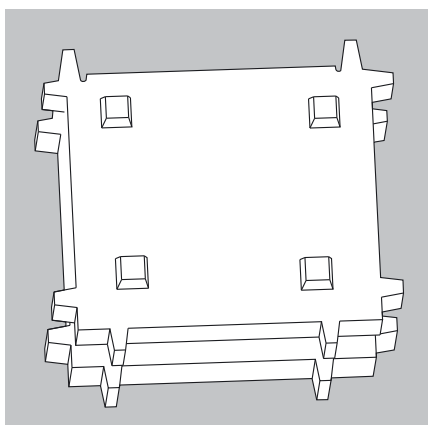

- ▶ Put the top part of the packaging over the device parts.
- ▶ Next, put the packaged balance into the cardboard box and seal the box.

13. Care and Maintenance

13.1 Service

To ensure the continued accuracy of your balance, we recommend scheduling regular servicing at least once a year. Sartorius Service offers different service contracts with maintenance intervals that are tailored to your needs (see www.sartorius.com/service). A calibration certificate should be issued as part of every maintenance session. Have a qualified electrician inspect the technical safety of the AC adaptor and its connections at appropriate intervals (e.g., every two years).



Repairs

Repair work must only be carried out by trained service technicians. Never attempt to repair the equipment when the power is turned on! Unplug the AC adaptor from the electrical outlet (mains supply) beforehand. Repairs performed by untrained persons will invalidate the warranty, and may result in considerable hazards for the user and cause the balance to produce inaccurate results. Contact Sartorius Service or a Sartorius dealer for the proper repair of your balance.

The device must be unplugged during repair work. Unplug the power cord. Repair work must only be performed by trained technicians.

13.2 Cleaning the Balance

Cleaning the Control Panel

Switch the display to Standby mode to avoid modifying the settings for operation during cleaning.



- ▶ Touch the Menu key to switch to the application selection.



- ▶ When  is then selected, the display goes off.



- ▶ To switch the display back on again: Select  at the bottom left of the display. The balance starts in the application that was most recently used before it was switched off.

Cleaning the Balance Housing



- ▶ Disconnect from the supply voltage: Disconnect the device from the power supply. If necessary, disconnect the data cable from the balance.



Never open the balance or the AC adaptor.
The parts contained in these cannot be cleaned, repaired, or replaced by the operator.

- Make sure that no liquid or dust gets into the balance or the AC adaptor.
- Remove the base plate, pan support, and weighing pan from the draft shield.
- Never use cleaning agents that contain solvents or abrasive ingredients which may ultimately damage the equipment.
Secura® and Quintix® Models:
- ▶ The plastic top and bottom parts of the balance housing are coated with a special substance that allows these parts to be cleaned using acetone.



Do not clean the following parts with acetone or aggressive cleaning agents: control panel, mains plug, data interface, labels, verified seal, or any other plastic parts.

- ▶ Wipe the balance with a soft, dry cloth after cleaning.



Contaminated Equipment:

- Health risks from product contamination due to product deposits and the collection of residue with microbial contaminations.
- Health risk from biological or microbiological substances.
- Observe cleaning specifications.
- Examine the cleaning results closely.

Cleaning the Draft Shield

A) Remove the side panels:

- 1) Pull the side panels towards the rear stop and lift them up carefully.
- 2) Pull the side panels out towards the back.

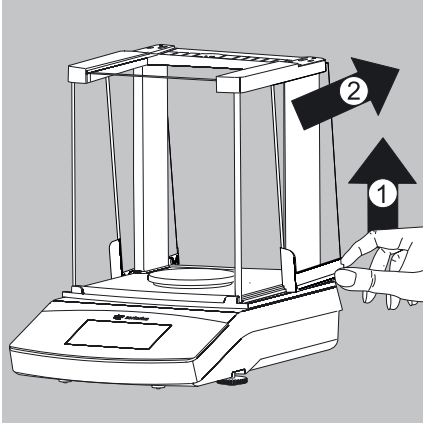

B) Remove the top glass cover:

- 1) Holding it by its rear edge, pull the draft shield cover up.
- 2) Remove the draft shield cover.

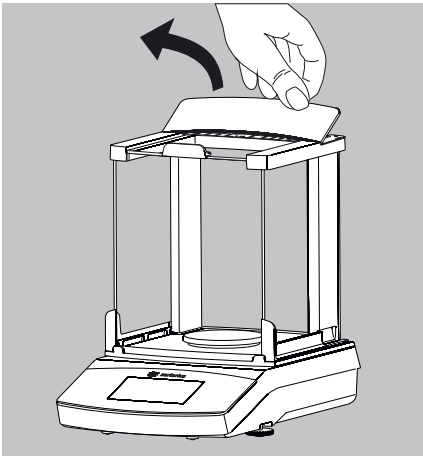

- 3) Remove the top glass cover by pulling it backward.

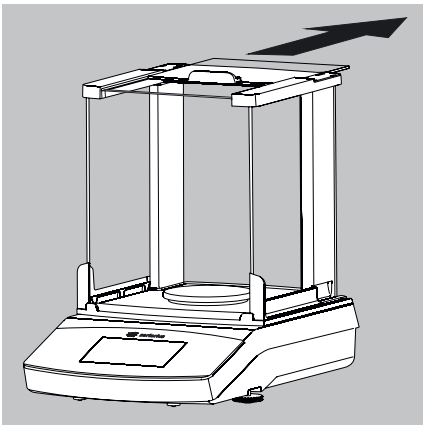

C) Remove the front and rear glass:

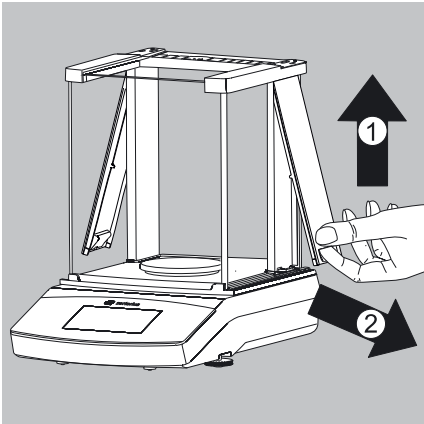

- 4) Lift the frame cover.
- 5) Pull the frame cover out.

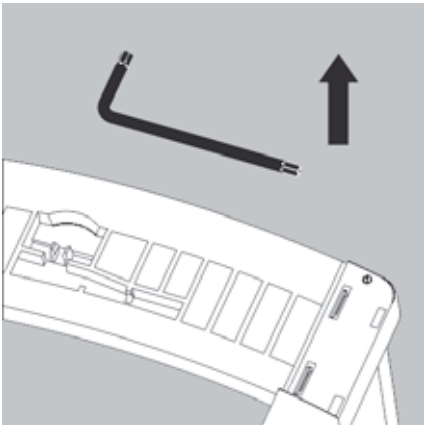

- ▶ Remove the Torx key up from the draft shield under the cover.

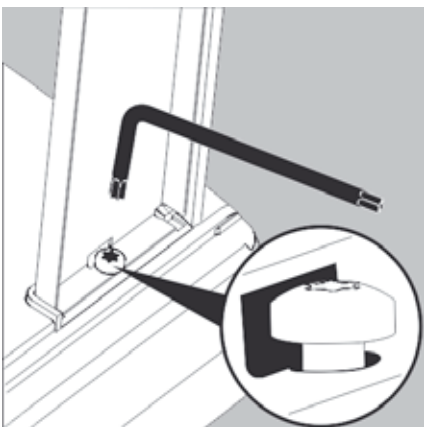

- 6) Turn the key approx. two times to loosen the Torx screws.

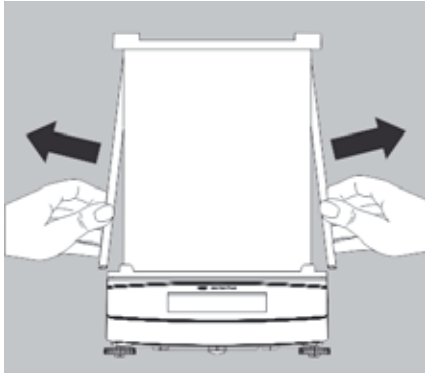

7) Pull out the draft shield frame from the side of the guide

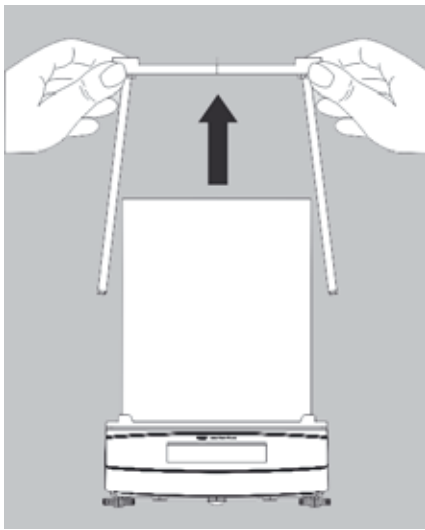

and remove the draft shield frame by pulling up.

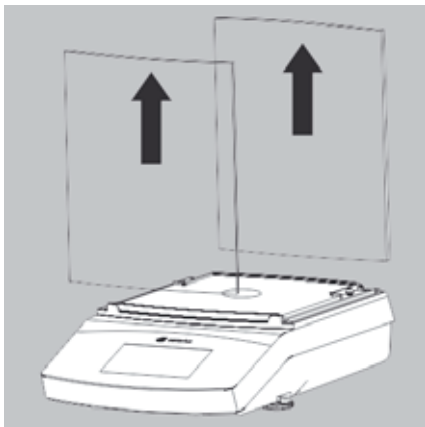

8) Pull out the front and rear glass panels (upwards).

Assembling the Draft Shield

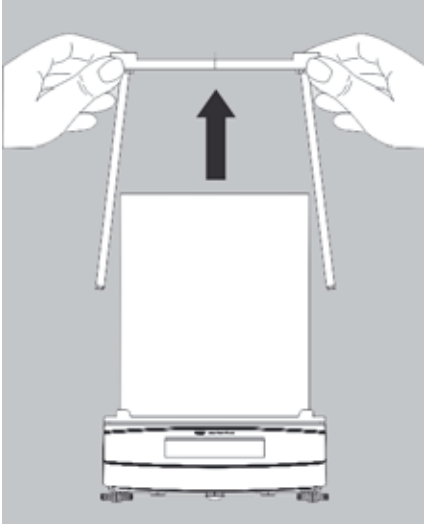

- ▶ Place the front and rear glass panels back into the guide.
- ▶ Center the draft shield frame in the guide.

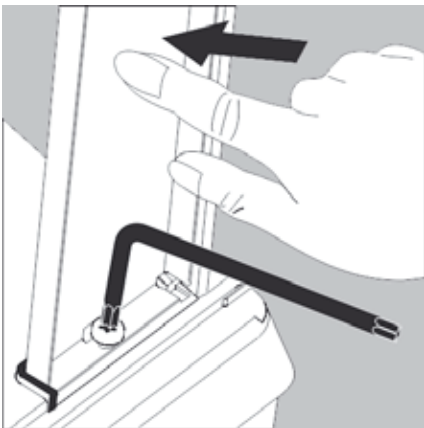

- ▶ Press the draft shield frame down against the stop and secure it again with both Torx screws.
- ▶ Assemble the rest of the components in reverse order: See Chapter "Getting Started – Installing the Balance."

14. Disposal



The packaging consists of environmentally friendly materials that can serve as secondary raw materials. If the packaging is no longer required, it can be disposed of in Germany at no charge via the dual system of the company VfW (contract number D-59101-2009-1129). Otherwise, dispose of the material according to the applicable local regulations for waste disposal. The device, including accessories and batteries, should not be disposed of as household waste. It should instead be recycled as for electrical and electronic devices. For more information regarding disposal and recycling, please contact our local service representatives. In addition, the partners listed on the following website are available to assist you within the EU:

- 1) Go to <http://www.sartorius.com>.
- 2) In the menu bar, select "Service."
- 3) Then select "Disposal Information."
- 4) The addresses of the local Sartorius disposal contacts can be found in the PDF files listed on this page.



Sartorius will not take back equipment contaminated with hazardous materials (ABC contamination) – either for repair or disposal.

Service Address for Disposal

Detailed information with service addresses for returning your device for repair or disposal can be found on our website (www.sartorius.com) or requested from a Sartorius Service Center.

15. Specifications

15.1 General Data

AC adapter

Sartorius AC adapter module	6971790 with replaceable, country-specific power plug adapters
Primary	100 - 240 V~, -10% / +10%, 50 - 60 Hz, 0.2 A
Secondary	15 V DC, $\pm 5\%$, 530 mA (max.) / 8 W (max.): 0 to +40°C and 15 V DC, $\pm 5\%$, 330 mA (max.) / 5 W (max.): 0 to +50°C
Other data	Protection class II in accordance with EN/IEC 60950-1 / up to 3000 m above sea level / IP40 in accordance with EN 60529/IEC 60529

Balance

Power supply	Only via Sartorius AC adapter module 6971790
Input supply voltage	12.0 - 15.0 V DC
Power consumption	2 W (typically)

Ambient Conditions

The specifications apply under the following ambient conditions:

Environment	For indoor use only
Ambient temperature*	+10°C to +30°C
Operational capability	Guaranteed between +5°C and +45°C
Storage and shipping	-10°C to +60°C
Height	Up to 3000 m above sea level
Relative humidity**	15% to 80% for temperatures up to 31°C non-condensing, decreasing linearly up to 50% relative humidity at 40°C and 20% at 50°C

Safety of Electrical Equipment	In accordance with EN 61010-1/IEC 61010-1 Safety requirements for electrical equipment for measurement, control and laboratory use – Part 1: General requirements
---------------------------------------	---

Electromagnetic Compatibility	In accordance with EN 61326-1/IEC 61326-1 Electrical equipment for measurement, control and laboratory use – EMC requirements – Part 1: General requirements
--------------------------------------	---

Interference resistance:	Suitable for use in industrial areas
Transient emissions:	Class B (suitable for use in residential areas and areas that are connected to a low voltage network that (also) supplies residential buildings). The device can therefore be used in both areas.

Standard Equipment

Selectable weight units ¹	Gram, kilogram, carat, pound, ounce, troy ounce, Hong Kong tael, Singapore tael, Taiwanese tael, grain, pennyweight, milligram, parts per pound, Chinese tael, momme, Austrian carat, tola, baht, mesghal and Newton
Available application programs	Secura® models: Counting, percentage, density determination, peak hold, unstable condition, checkweighing, mixing, components (totalizing), statistics, conversion, SQmin, and identifiers Quintix® models: Counting, percentage, density determination, peak hold, unstable condition, checkweighing, mixing, components (totalizing), statistics, conversion Practum® models: Counting, percentage, density determination, peak hold, unstable condition, checkweighing



Verified balances in accordance with EU requirements comply with the requirements of Council Directive 2009/23/EC with EN 45501:1992 and OIML R76:2006.



* For verified balances in accordance with EU requirements, refer to the information on the balance.

** For verified balances in accordance with EU requirements, the legal regulations apply.

1) Depending on the country-specific model version, not all weight units listed may be available.

FCC Rules

Safety Precautions:

NOTE: This equipment has been tested and found to comply with the limits for a Class B digital device, pursuant to part 15 of the FCC Rules. These limits are designed to provide reasonable protection against harmful interference in a residential installation. This equipment generates, uses and can radiate radio frequency energy and, if not installed and used in accordance with the instructions, may cause harmful interference to radio communications. However, there is no guarantee that interference will not occur in a particular installation. If this equipment does cause harmful interference to radio or television reception, which can be determined by turning the equipment off and on, the user is encouraged to try to correct the interference by one or more of the following measures:

- Reorient or relocate the receiving antenna.
- Increase the separation between the equipment and receiver.
- Connect the equipment into an outlet on a circuit different from that to which the receiver
- Consult the dealer or an experienced radio/TV technician for help.

Shielded Cables:

Connections between the devices and peripherals must be made using shielded cables in order to maintain compliance with FCC radio frequency emission limits.

Modifications:

Any modifications made to this devices that are not approved by Sartorius Lab Instruments GmbH & Co. KG may void the authority granted to the user by the FCC to operate this equipment.

15.2 Model-specific Data

		Secura®														
Model		224-1x ¹⁾	124-1x ¹⁾	1103-1x ¹⁾	613-1x ¹⁾	513-1x ¹⁾	313-1x ¹⁾	213-1x ¹⁾	6102-1x ¹⁾	5102-1x ¹⁾	3102-1x ¹⁾	2102-1x ¹⁾	1102-1x ¹⁾	612-1x ¹⁾	6101-1x ¹⁾	3101-1x ¹⁾
Weighing capacity	g	220	120	1,100	610	510	310	210	6100	5100	3100	2100	1100	610	6,100	3,100
Readability	mg	0.1	0.1	1	1	1	1	1	10	10	10	10	10	10	100	100
Repeatability (standard deviation)	mg	0.1	0.1	1	1	1	1	1	10	10	10	10	10	10	50	50
Linearity deviation	mg	0.2	0.2	2	2	2	2	2	20	20	20	20	20	20	100	100
Min. initial weight according to USP, typical	g	0.12	0.12	1.5	1.5	1.5	1.5	1.5	12	12	12	12	12	12	60	60
Sensitivity drift between +10 to +30°C	± ppm/K	1.5	1.5	1.5	2	2	2	2	2	2	2	2	2	2	2	2
Typical stabilization time	s	2	2	1.5	1	1	1	1	1	1	1	1	1	1	1	1
isoCAL:																
- Temperature change	K	1.5	1.5	1.5	2	2	2	2	2	2	2	2	2	2	2	2
- Time interval	h	4	4	4	6	6	6	6	6	6	6	6	6	6	6	6
Display result (depending on the set filter level)	s	0.2	0.2	0.1/0.2	0.1/0.2	0.1/0.2	0.1/0.2	0.1/0.2	0.1/0.2	0.1/0.2	0.1/0.2	0.1/0.2	0.1/0.2	0.1/0.2	0.1/0.2	0.1/0.2
Weighing pan size	mm	∅ 90	∅ 90	∅ 120	∅ 120	∅ 120	∅ 120	∅ 120	∅ 180	∅ 180	∅ 180	∅ 180	∅ 180	∅ 180	∅ 180	∅ 180
Weighing chamber height*	mm	209	209	209	209	209	209	209	-	-	-	-	-	-	-	-
Net weight, approx.	kg	5.1	5.1	5.9	5.1	5.1	5.1	5.1	5.2	5.2	5.2	5.2	5.2	4.7	5.2	5.2

		Quintix®												
Model		224-1x ¹⁾	124-1x ¹⁾	64-1x ¹⁾	613-1x ¹⁾	513-1x ¹⁾	313-1x ¹⁾	213-1x ¹⁾	6102-1x ¹⁾	5102-1x ¹⁾	3102-1x ¹⁾	2102-1x ¹⁾	1102-1x ¹⁾	
Weighing capacity	g	220	120	60	610	510	310	210	6100	5100	3100	2100	1100	
Readability	mg	0.1	0.1	0.1	1	1	1	1	10	10	10	10	10	
Repeatability (standard deviation)	mg	0.1	0.1	0.1	1	1	1	1	10	10	10	10	10	
Linearity deviation	mg	0.1	0.1	0.1	2	2	2	2	20	20	20	30	30	
Sensitivity drift between +10 to +30°C	± ppm/K	1.5	1.5	1.5	3	3	3	3	3	3	3	4	4	
Typical stabilization time	s	2	2	2	1	1	1	1	1	1	1	1.5	1.5	
isoCAL:														
- Temperature change	K	1.5	1.5	1.5	2	2	2	2	2	2	2	2	2	
- Time interval	h	4	4	4	6	6	6	6	6	6	6	6	6	
Display result (depending on the set filter level)	s	0.2	0.2	0.2	0.1/0.2	0.1/0.2	0.1/0.2	0.1/0.2	0.1/0.2	0.1/0.2	0.1/0.2	0.1/0.2	0.1/0.2	
Weighing pan size	mm	∅ 90	∅ 90	∅ 90	∅ 120	∅ 120	∅ 120	∅ 120	∅ 180	∅ 180	∅ 180	∅ 180	∅ 180	
Weighing chamber height*	mm	209	209	209	209	209	209	209	-	-	-	-	-	
Net weight, approx.	kg	4.9	4.9	4.9	4.9	4.9	4.9	4.9	5.2	5.2	5.2	4.7	4.7	

¹⁾ Possible terms for country-specific models:

- x = S: Standard balances without country-specific additions
- x = SAR: Standard balances with country-specific additions for Argentina
- x = SJP: Standard balances with country-specific additions for Japan
- x = SKR: Standard balances with country-specific additions for South Korea

* Upper edge of the weighing pan to the lower edge of the upper draft shield panel

Quintix®

Model		612-1x ¹⁾	412-1x ¹⁾	6101-1x ¹⁾	5101-1x ¹⁾	2101-1x ¹⁾	6100-1x ¹⁾	5100-1x ¹⁾
Weighing capacity	g	610	410	6100	5100	2100	6100	5100
Readability	mg	10	10	100	100	100	1000	1000
Repeatability (standard deviation)	mg	10	10	100	100	100	500	500
Linearity deviation	mg	30	30	300	300	300	1000	1000
Sensitivity drift between +10 to +30°C	± ppm/K	4	4	8	8	8	8	8
Typical stabilization time	s	1.5	1.5	1.5	1.5	1.5	1	1
isoCAL:								
- Temperature change	K	2	2	2	2	2	2	2
- Time interval	h	6	6	6	6	6	6	6
Display result (depending on the set filter level)	s	0.1/0.2	0.1/0.2	0.1/0.2	0.1/0.2	0.1/0.2	0.1/0.2	0.1/0.2
Weighing pan size	mm	∅ 180	∅ 180	∅ 180	∅ 180	∅ 180	∅ 180	∅ 180
Net weight, approx.	kg	4.7	4.7	4.7	4.7	4.7	4.7	4.7

Practum®

Model		224-1x ¹⁾	124-1x ¹⁾	64-1x ¹⁾	513-1x ¹⁾	313-1x ¹⁾	213-1x ¹⁾	3102-1x ¹⁾	2102-1x ¹⁾	1102-1x ¹⁾	612-1x ¹⁾	412-1x ¹⁾
Weighing capacity	g	220	120	60	510	310	210	3100	2100	1100	610	410
Readability	mg	0.1	0.1	0.1	1	1	1	10	10	10	10	10
Repeatability (standard deviation)	mg	0.1	0.1	0.1	1	1	1	10	10	10	10	10
Linearity deviation	mg	2	2	2	1	2	2	30	30	30	30	30
Sensitivity drift between +10 to +30°C	± ppm/K	2	2	2	3	3	3	4	4	4	4	4
Typical stabilization time	s	2	2	2	1	1	1	1.5	1.5	1.5	1.5	1.5
Weighing pan size	mm	∅ 90	∅ 90	∅ 90	∅ 120	∅ 120	∅ 120	∅ 180	∅ 180	∅ 180	∅ 180	∅ 180
Weighing chamber height*	mm	209	209	209	209	209	209	-	-	-	-	-
Net weight, approx.	kg	4.5	4.5	4.5	4.9	4.9	4.9	3.1	3.1	3.1	3.1	3.1

Practum®

Model		6101-1x ¹⁾	5101-1x ¹⁾	2101-1x ¹⁾	6100-1x ¹⁾	5100-1x ¹⁾
Weighing capacity	g	6100	5100	2100	6100	5100
Readability	mg	100	100	100	1000	1000
Repeatability (standard deviation)	mg	100	100	100	500	500
Linearity deviation	mg	300	300	300	1000	1000
Sensitivity drift between +10 to +30°C	± ppm/K	8	8	8	8	8
Typical stabilization time	s	1.5	1.5	1.5		1
Weighing pan size	mm	∅ 180	∅ 180	∅ 180	∅ 180	∅ 180
Net weight, approx.	kg	3.1	3.1	3.1	3.1	3.1

¹⁾ Possible terms for country-specific models:

- x = S: Standard balances without country-specific additions
- x = SAR: Standard balances with country-specific additions for Argentina
- x = SJP: Standard balances with country-specific additions for Japan
- x = SKR: Standard balances with country-specific additions for South Korea

* Upper edge of the weighing pan to the lower edge of the upper draft shield panel

15.3 Verified Models with Country-specific Type Approval Certificate

		Secura®									
Model		224-1x ²⁾	124-1x ²⁾	1103-1x ²⁾	613-1x ²⁾	513-1x ²⁾	313-1x ²⁾	213-1x ²⁾	6102-1x ²⁾	5102-1x ²⁾	3102-1x ²⁾
Accuracy class		I	I	I	II	II	II	II	II	II	II
Type ³⁾		SQP-A	SQP-A	SQP-I	SQP-B	SQP-B	SQP-B	SQP-B	SQP-C	SQP-C	SQP-C
Max	g	220	120	1,100	610	510	310	210	6100	5100	3100
Scale interval d	mg	0.1	0.1	1	1	1	1	1	10	10	10
Verification scale interval e	mg	1	1	10	10	10	10	10	100	100	100
Min	mg	10	10	100	20	20	20	20	500	500	500
Min (only for Models ...-10IN)	mg	100	100	-	200	200	200	200	5,000	5,000	5,000
Tare equalization range (subtractive)		< 100% of max. weighing capacity									
Min. initial weight according to USP, typical	g	0.12	0.12	1.5	1.5	1.5	1.5	1.5	12	12	12
Typical stabilization time	s	2	2	1.5	1	1	1	1	1	1	1
isoCAL:											
- Temperature change	K	1.5	1.5	1.5	2	2	2	2	2	2	2
- Time interval	h	4	4	4	6	6	6	6	6	6	6
Display result (depending on the set filter level)	s	0.2	0.2	0.1/0.2	0.1/0.2	0.1/0.2	0.1/0.2	0.1/0.2	0.1/0.2	0.1/0.2	0.1/0.2
Weighing pan size	mm	∅ 90	∅ 90	∅ 120	d 120	∅ 120	∅ 120	∅ 120	∅ 180	∅ 180	∅ 180
Weighing chamber height*	mm	209	209	209	209	209	209	209	-	-	-
Net weight, approx.	kg	5.1	5.1	5.9	5.1	5.1	5.1	5.1	5.2	5.2	5.2

Model		2102-1x ²⁾	1102-1x ²⁾	612-1x ²⁾	6101-1x ²⁾	3101-1x ²⁾
Accuracy class		II	II	II	II	II
Type ³⁾		SQP-C	SQP-C	SQP-C	SQP-C	SQP-C
Max	g	2,100	1,100	610	6,100	3,100
Scale interval d	mg	10	10	10	100	100
Verification scale interval e	mg	100	100	100	100	100
Min	mg	500	500	500	5,000	5,000
Min (only for Models ...-10IN)	g	5	5	5	5	5
Tare equalization range (subtractive)		< 100% of max. weighing capacity				
Min. initial weight according to USP, typical	g	12	12	12	60	60
Typical stabilization time	s	1	1	1	1	1
isoCAL:						
- Temperature change	K	2	2	2	2	2
- Time interval	h	6	6	6	6	6
Display result (depending on the set filter level)	s	0.1/0.2	0.1/0.2	0.1/0.2	0.1/0.2	0.1/0.2
Weighing pan size	mm	∅ 180	∅ 180	∅ 180	∅ 180	∅ 180
Net weight, approx.	kg	5.2	5.2	5.2	5.2	5.2

2) Possible terms for country-specific models:

- x = CEU: Verified balances with EC Type Approval Certificate D12-09-014 without country specific additions
- x = CFR: Verified balances with EC Type Approval Certificate D12-09-014 for France only
- x = CIT: Verified balances with EC Type Approval Certificate D12-09-014 for Italy only
- x = CCH: Verified balances with EC Type Approval Certificate D12-09-014 for Switzerland only

x = CN: CMC Type Approval Certificate for China

- x = OJP: Balance with Type Approval Certificate for Japan
- x = OBR: Balance with Type Approval Certificate for Brazil
- x = ORU: Balance with Type Approval Certificate for Russia
- x = OIN: Balance with Type Approval Certificate for India
- x = OAU: Balance with Type Approval Certificate for Australia

3) All models with "...CN": type "SQP"

* Upper edge of the weighing pan to the lower edge of the upper draft shield panel

		Quintix®								
Model		224-1x ¹⁾	124-1x ¹⁾	64-1x ¹⁾	613-1x ¹⁾	513-1x ¹⁾	313-1x ¹⁾	213-1x ¹⁾	6102-1x ¹⁾	5102-1x ¹⁾
Accuracy class		Ⓡ	Ⓡ	Ⓡ	Ⓢ	Ⓢ	Ⓢ	Ⓢ	Ⓢ	Ⓢ
Type ²⁾		SQP-A	SQP-A	SQP-A	SQP-B	SQP-B	SQP-B	SQP-B	SQP-C	SQP-C
Max	g	220	120	60	610	510	310	210	6,100	5,100
Scale interval d	mg	0.1	0.1	0.1	1	1	1	1	10	10
Verification scale interval e	mg	1	1	1	10	10	10	10	100	100
Min	mg	10	10	10	20	20	20	20	500	500
Min (only for Models ...-10IN)	mg	100	100	100	200	200	200	200	5,000	5,000
Tare equalization range (subtractive)		< 100% from max. weighing capacity								
Typical stabilization time	s	2	2	2	1	1	1	1	1	1
isoCAL:										
- Temperature change	K	1.5	1.5	1.5	2	2	2	2	2	2
- Time interval	h	4	4	4	4	4	6	6	6	6
Display result (depending on the set filter level)	s	0.2	0.2	0.2	0.1/0.2	0.1/0.2	0.1/0.2	0.1/0.2	0.1/0.2	0.1/0.2
Weighing pan size	mm	∅ 90	∅ 90	∅ 90	∅ 120	∅ 120	∅ 120	∅ 120	∅ 180	∅ 180
Weighing chamber height*	mm	209	209	209	209	209	209	209	-	-
Net weight, approx.	kg	4.9	4.9	4.9	4.9	4.9	4.9	4.9	5.2	5.2

		Quintix®							
Model		3102-1x ¹⁾	2102-1x ¹⁾	1102-1x ¹⁾	612-1x ¹⁾	6101-1x ¹⁾	5101-1x ¹⁾	6100-1x ¹⁾	5100-1x ¹⁾
Accuracy class		Ⓢ	Ⓢ	Ⓢ	Ⓢ	Ⓢ	Ⓢ	Ⓢ	Ⓢ
Type ²⁾		SQP-C	SQP-C	SQP-C	SQP-C	SQP-E	SQP-E	SQP-E	SQP-E
Max	g	3,100	2,100	1,100	610	6,100	5,100	6,100	5,100
Scale interval d	g	10	10	10	0.01	0.1	0.1	1	1
Verification scale interval e	g	100	100	100	0.1	1	1	1	1
Min	mg	500	500	500	0.5	5	5	50	50
Min (only for Models ...-10IN)	g	5	5	5	5	5	5	50	50
Tare equalization range (subtractive)		< 100% from max. weighing capacity							
Typical stabilization time	s	1	1.5	1.5	1.5	1.5	1.5	1	1
isoCAL:									
- Temperature change	K	2	2	2	2	2	2	2	2
- Time interval	h	6	6	6	6	6	6	6	6
Display result (depending on the set filter level)	s	0.1/0.2	0.1/0.2	0.1/0.2	0.1/0.2	0.1/0.2	0.1/0.2	0.1/0.2	0.1/0.2
Weighing pan size	mm	∅ 180	∅ 180	∅ 180	∅ 180	∅ 180	∅ 180	∅ 180	∅ 180
Net weight, approx.	kg	4.7	4.7	4.7	4.7	4.7	4.7	4.7	4.7

		Practum®							
Model		224-1x ¹⁾	124-1x ¹⁾	64-1x ¹⁾	513-1x ¹⁾	313-1x ¹⁾	213-1x ¹⁾	3102-1x ¹⁾	2102-1x ¹⁾
Accuracy class		I	I	I	II	II	II	II	II
Type ²⁾		SQP-A	SQP-A	SQP-A	SQP-B	SQP-B	SQP-B	SQP-C	SQP-C
Max	g	220	120	60	510	310	210	3100	2100
Scale interval d	mg	0.1	0.1	0.1	1	1	1	10	10
Verification scale interval e	mg	1	1	1	10	10	10	100	100
Min	mg	10	10	10	20	20	20	500	500
Min (only for Models ...-10IN)	mg	100	100	100	200	200	200	5,000	5,000
Tare equalization range (subtractive)		< 100% from max. weighing capacity							
Typical stabilization time	s	1	2	2	1	1	1	1.5	1.5
Weighing pan size	mm	∅ 90	∅ 90	∅ 90	∅ 120	∅ 120	∅ 120	∅ 180	∅ 180
Weighing chamber height*	mm	209	209	209	209	209	209	-	-
Net weight, approx.	kg	4.5	4.5	4.5	4.9	4.9	4.9	3.1	3.1

		Practum®					
Model		1102-1x ¹⁾	612-1x ¹⁾	6101-1x ¹⁾	5101-1x ¹⁾	6100-1x ¹⁾	5100-1x ¹⁾
Accuracy class		II	II	II	II	II	II
Type ²⁾		SQP-C	SQP-C	SQP-E	SQP-E	SQP-E	SQP-E
Max	g	1,100	610	6,100	5,100	6,100	5,100
Scale interval d	mg	10	10	100	100	1,000	1,000
Verification scale interval e	mg	100	100	1,000	1,000	1,000	1,000
Min	g	0.5	0.5	5	5	50	50
Min (only for Models ...-10IN)	g	5	5	50	50	50	50
Tare equalization range (subtractive)		< 100% from max. weighing capacity					
Typical stabilization time	s	1.5	1.5	1.5	1.5	1	1
Weighing pan size	mm	∅ 180	∅ 180	∅ 180	∅ 180	∅ 180	∅ 180
Net weight, approx.	kg	3.1	3.1	3.1	3.1	3.1	3.1

¹⁾ Possible terms for country-specific models:

- x = CEU: Verified balances with EC Type Approval Certificate D12-09-014 without country specific additions
- x = CFR: Verified balances with EC Type Approval Certificate D12-09-014 for France only
- x = CIT: Verified balances with EC Type Approval Certificate D12-09-014 for Italy only
- x = CCH: Verified balances with EC Type Approval Certificate D12-09-014 for Switzerland only
- x = CN: CMC Type Approval Certificate for China
- x = OJP: Balance with Type Approval Certificate for Japan
- x = OBR: Balance with Type Approval Certificate for Brazil
- x = ORU: Balance with Type Approval Certificate for Russia
- x = OIN: Balance with Type Approval Certificate for India
- x = OAU: Balance with Type Approval Certificate for Australia

²⁾ All models with "...CN": type "SQP"

* Upper edge of the weighing pan to the lower edge of the upper draft shield panel

15.4 Accessories

General Information

Set of rechargeable batteries for standard laboratory balances	YRB11Z
Draft shield for precision balances	YDS01SQP
Round glass draft shield for milligram balances	YDS02SQP
In-use dust cover for analytical balances	6960SE01
In-use dust cover for precision balances	6960SE02
Dust cover for analytical balances with draft shield	6960SE03
USP Minimum sample weight certificate	84CGNA

Printers and Communication

Premium GLP Laboratory Printer	YDP30
– Printer paper for GLP lab printer	69Y03285
– Continuous labels GLP lab printer	69Y03286
Standard lab printer	YDP40
– Printer paper for lab printer	69Y03287
Data cable for Mini USB/USB A	YCC04-D09
Data cable for Mini USB/9-pin RS-232	YCC03-D09
Data cable for Mini USB/25-pin RS-232	YCC03-D25

Density Determination

Density determination set for analytical balances and milligram balances	YDK03
Density determination set for precision balances	YDK04

Calibration Weights

Calibration weight for lab balance type 64	YCW452-AC-02
– Proof Line knob weight 50 g, OIML Class E2, with DAkkS certificate	
Calibration weight for lab balance type 124	YCW512-AC-02
– Proof Line knob weight 100 g, OIML Class E2, with DAkkS certificate	
Calibration weight for lab balance type 224; 313; 213	YCW522-AC-02
– Proof Line knob weight 200 g, OIML Class E2, with DAkkS certificate	
Calibration weight for lab balance type 613; 513; 612	YCW552-AC-02
– Proof Line knob weight 500 g, OIML Class E2, with DAkkS certificate	
Calibration weight for lab balance type 412; 212	YCW524-AC-02
– Proof Line knob weight 200 g, OIML Class F2, with DAkkS certificate	
Calibration weight for lab balance type 1102	YCW612-AC-02
– Proof Line knob weight 1 kg, OIML Class E2, with DAkkS certificate	
Calibration weight for lab balance type 3102; 2102	YCW622-AC-02
– Proof Line knob weight 2 kg, OIML Class E2, with DAkkS certificate	
Calibration weight for lab balance type 6102; 5102	YCW652-AC-02
– Proof Line knob weight 5 kg, OIML Class E2, with DAkkS certificate	
Calibration weight for lab balance type 6101; 5101	YCW653-AC-02
– Proof Line knob weight 5 kg, OIML Class F1, with DAkkS certificate	
Calibration weight for lab balance type 3101; 2101	YCW624-AC-02
– Proof Line knob weight 2 kg, OIML Class F2, with DAkkS certificate	

15.5 Balance Dimensions

Secura® models with readability of 0.1 mg

All dimensions are given in millimeters

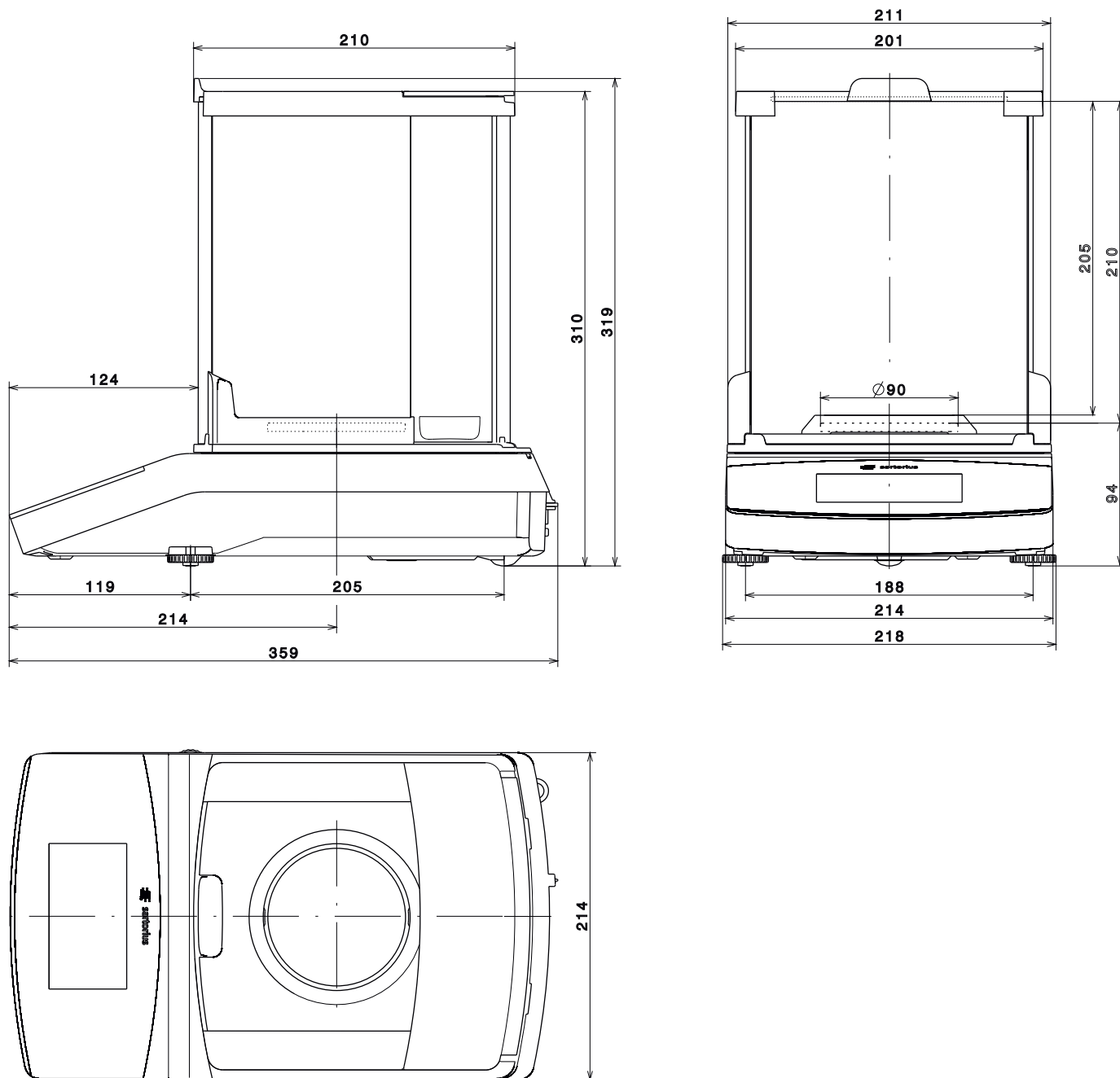

Quintix® and Practum® models with readability of 0.1 mg

All dimensions are given in millimeters

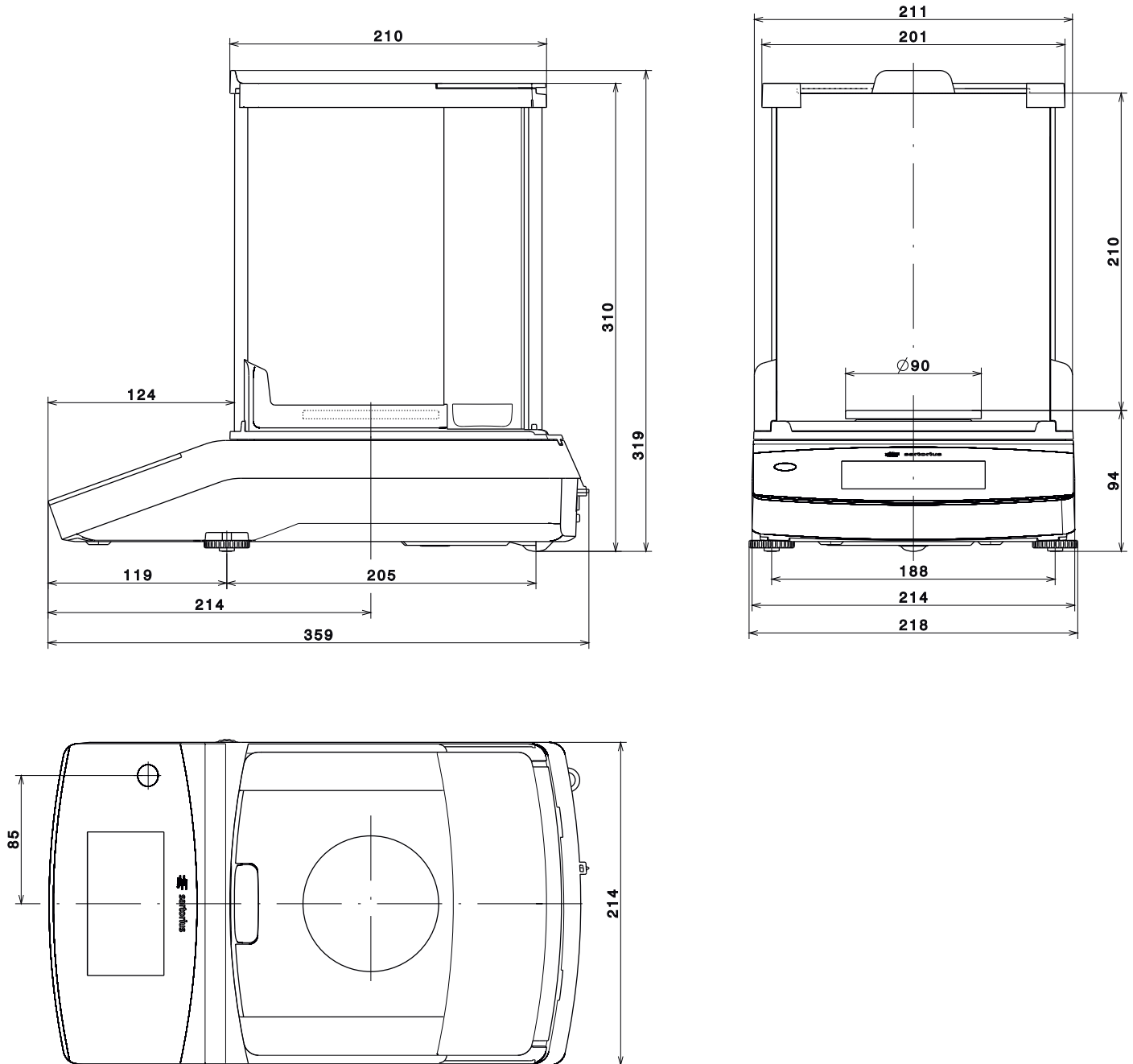

Models with readability of 1 mg

All dimensions are given in millimeters

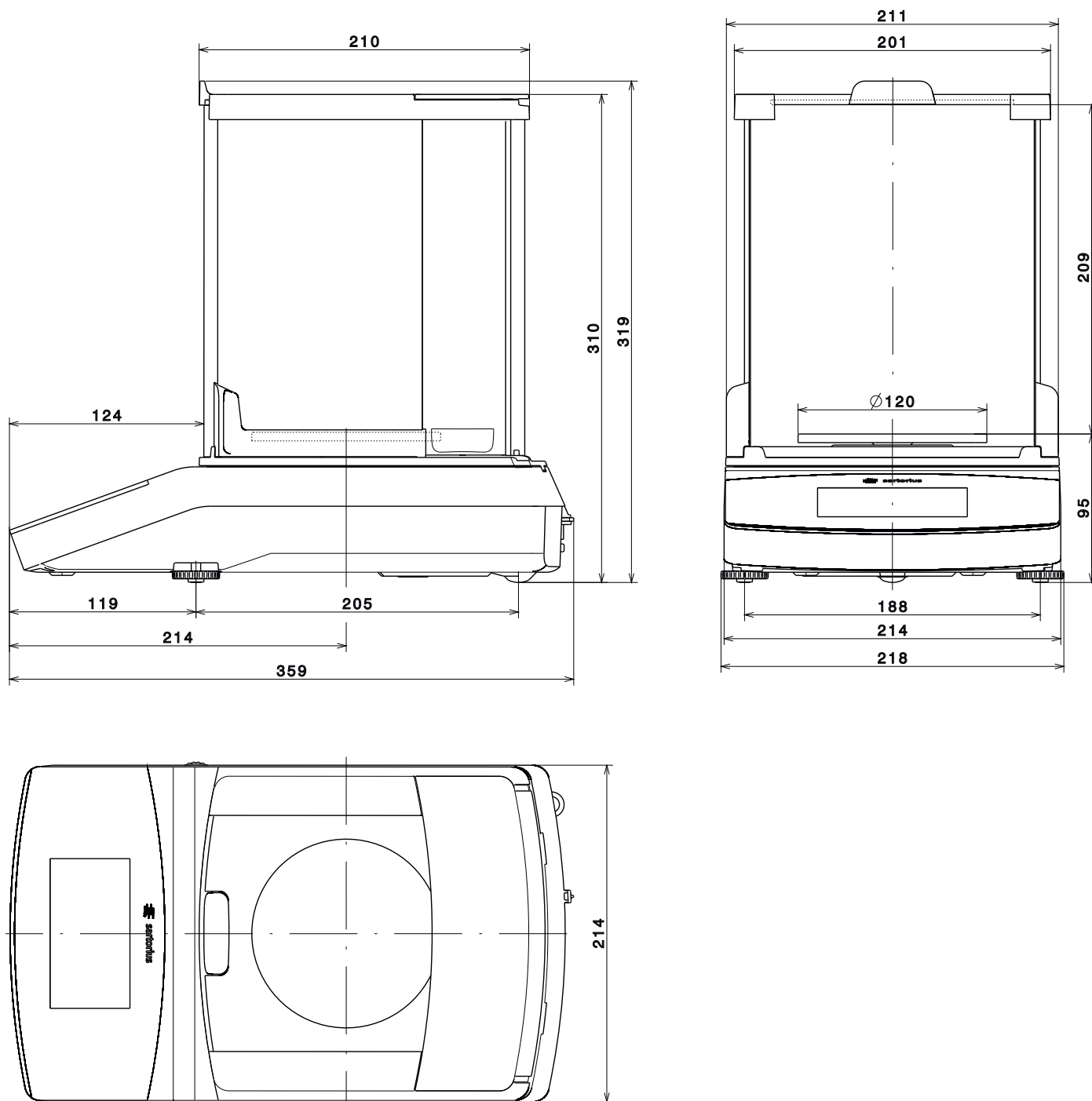

Secura®: All models with a readability of ≥ 10 mg

Quintix®: Models 6102..., 5102..., 3102..., 2102-1C..., 2102-10..., 1102-1C..., 1102-10..., 612-1C..., 612-10...

Practum®: Models 1102-10..., 2102-10..., 3102..., 612-10...

All dimensions are given in millimeters

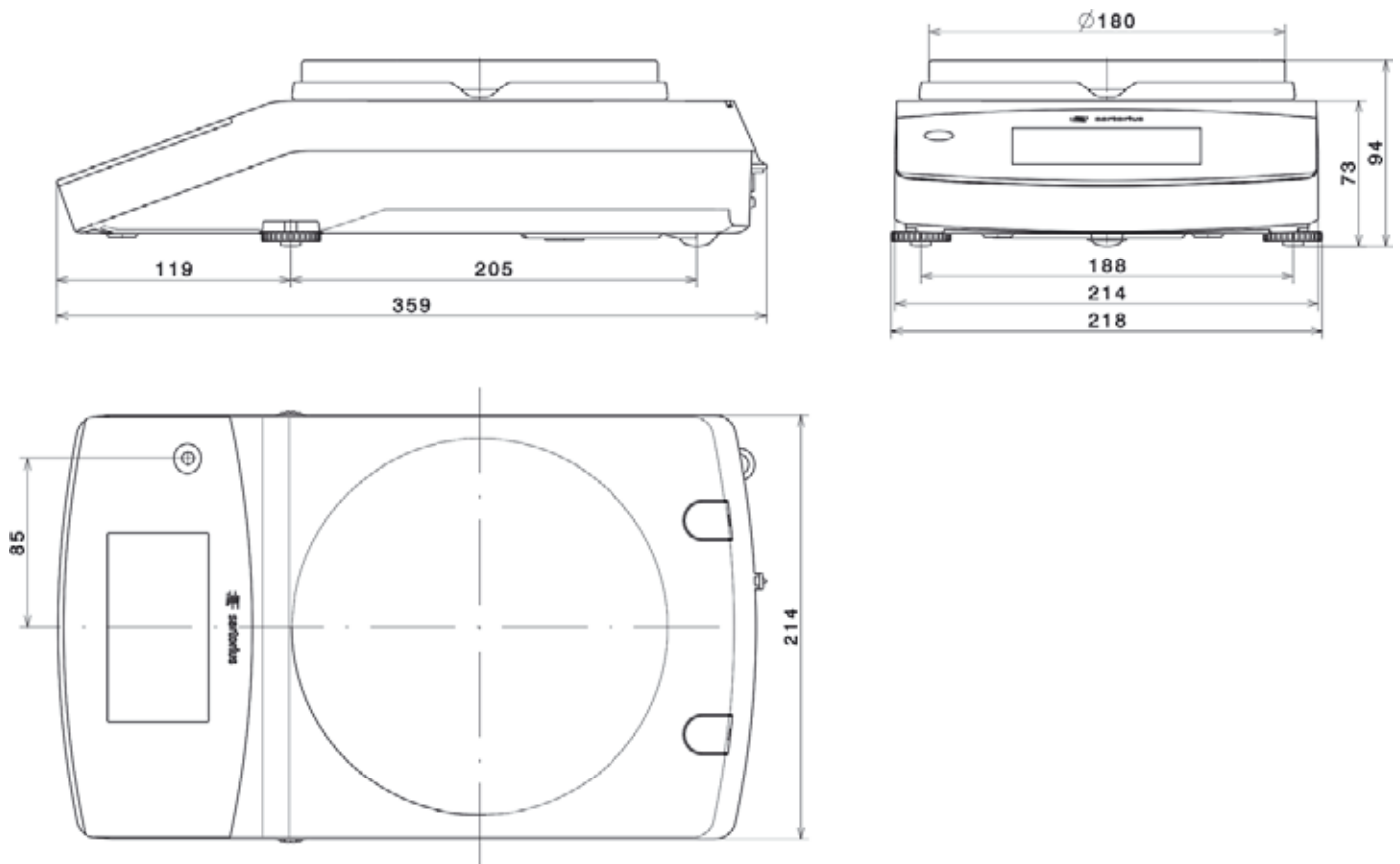

Models with a readability of ≥ 100 mg

Quintix®: Models 2102-1S, 1102-1S, 612-1S, 412...

Practum®: Models 2102-1S, 1102-1S, 612-1S, 412...

All dimensions are given in millimeters

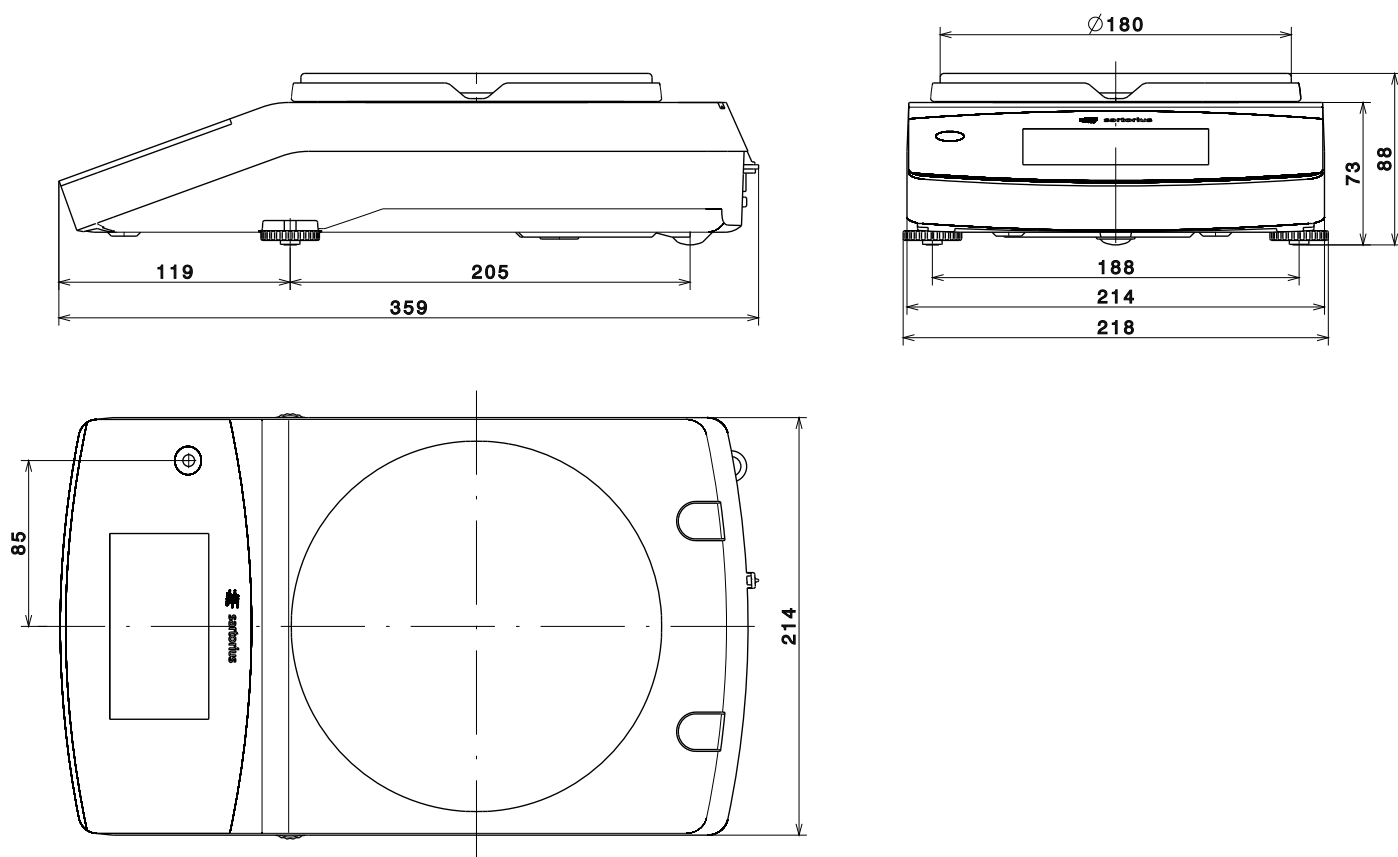

Appendix



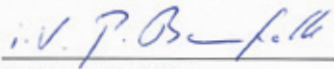
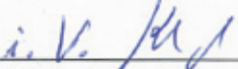

EG-/EU-Konformitätserklärung EC / EU Declaration of Conformity

Hersteller <i>Manufacturer</i>	Sartorius Lab Instruments GmbH & Co. KG Weender Landstrasse 94 – 108, D-37075 Goettingen, Germany
	erklärt in alleiniger Verantwortung, dass das Betriebsmittel <i>declares under own responsibility that the equipment</i>
Geräteart <i>Device type</i>	Elektronische Laborwaage <i>Electronically laboratory balance</i>
Baureihe <i>Type series</i>	Secura....-1..., Quintix....-1..., Practum....-1...
	in der von uns in Verkehr gebrachten Ausführung mit den grundlegenden Anforderungen der folgenden Europäischen Richtlinien übereinstimmt und die anwendbaren Anforderungen folgender harmonisierter Europäischer Normen erfüllt: <i>in the form as delivered complies with the essential requirements of the following European Directives and meets the applicable requirements of the harmonized European Standards listed below:</i>
2004/108/EG 2004/108/EC	Elektromagnetische Verträglichkeit <i>Electromagnetic compatibility</i> EN 61326-1:2006 Elektrische Mess-, Steuer-, Regel- und Laborgeräte - EMV- Anforderungen – Teil 1: Allgemeine Anforderungen <i>Electrical equipment for measurement, control and laboratory use – EMC requirements – Part 1: General requirements</i>
2006/95/EG 2006/95/EC	Elektrische Betriebsmittel zur Verwendung innerhalb bestimmter Spannungsgrenzen <i>Electrical equipment designed for use within certain voltage limits</i> EN 61010-1:2010 Sicherheitsbestimmungen für elektrische Mess-, Steuer-, Regel- und Laborgeräte – Teil 1: Allgemeine Anforderungen <i>Safety requirements for electrical equipment for measurement, control, and laboratory use – Part 1: General requirements</i>
2011/65/EU 2011/65/EU	Beschränkung der Verwendung bestimmter gefährlicher Stoffe in Elektro- und Elektronikgeräten (RoHS) <i>Restriction of the use of certain hazardous substances in electrical and electronic equipment (RoHS)</i> EN 50581:2012 Technische Dokumentation zur Beurteilung von Elektro- und Elektronikgeräten hinsichtlich der Beschränkung gefährlicher Stoffe <i>Technical documentation for the assessment of electrical and electronic products with respect to the restriction of hazardous substances</i>
	Jahreszahl der CE-Kennzeichenvergabe / Year of the CE mark assignment: 13
	Sartorius Lab Instruments GmbH & Co. KG Goettingen, 2013-09-18
	<div style="text-align: center;">  Dr. Reinhard Baumfalk Vice President R&D </div> <div style="text-align: center;">  Dr. Dieter Klausgrete Head of International Certification Management </div>
	Diese Erklärung bescheinigt die Übereinstimmung mit den genannten EG- und EU-Richtlinien, ist jedoch keine Zusicherung von Eigenschaften. Bei einer mit uns nicht abgestimmten Änderung des Produktes verliert diese Erklärung ihre Gültigkeit. Die Sicherheitshinweise der zugehörigen Produktdokumentation sind zu beachten. <i>This declaration certifies conformity with the above mentioned EC and EU Directives, but does not guarantee product attributes. Unauthorised product modifications make this declaration invalid. The safety information in the associated product documentation must be observed.</i>
	SLI13CE001-00.de,en 83122-000-58 OP-1.113-fo2



For verified balances, the conformity declaration supplied with the balance is valid for use in the EEA. Please retain this declaration.

Physikalisch-Technische Bundesanstalt**PTB**

Braunschweig und Berlin

**EG-Bauartzulassung***EC Type-approval Certificate*

Zulassungsinhaber: <i>Issued to:</i>	Sartorius Lab Instruments GmbH & Co. KG Weender Landstr. 94-108 37075 Göttingen
Rechtsbezug: <i>In accordance with:</i>	Richtlinie 2009/23/EG vom 23. April 2009 über nichtselbsttätige Waagen (ABl. L 122 S. 6). <i>Directive 2009/23/EC of 23 April 2009 on non-automatic weighing instruments (OJ L 122 p. 6)</i>
Bauart: <i>In respect of:</i>	Nichtselbsttätige elektromechanische Waage mit oder ohne Hebelwerk/ <i>Non-automatic electromechanical weighing instrument with or without lever system</i>
Typ: <i>Type:</i>	SQP...
Zulassungsnummer: <i>Approval No.:</i>	D12-09-014 2. Revision
Gültig bis: <i>Valid until:</i>	30.09.2022
Anzahl der Seiten: <i>Number of pages:</i>	13
Geschäftszeichen: <i>Reference No.:</i>	PTB-1.12-4068458
Benannte Stelle: <i>Notified Body:</i>	0102
Zertifizierung: <i>Certification:</i>	Braunschweig, 01.07.2014
Im Auftrag <i>On behalf of PTB</i>	Siegel <i>Seal</i>
	Bewertung: <i>Evaluation:</i>
	Im Auftrag <i>On behalf of PTB</i>

Dr. Oliver Mack



Dipl.-Ing. K. Schulz

EG-Bauartzulassungen ohne Unterschrift und Siegel haben keine Gültigkeit. Diese EG-Bauartzulassung darf nur unverändert weiter verbreitet werden. Auszüge bedürfen der Genehmigung der Physikalisch-Technischen Bundesanstalt.

EC Type-approval Certificates without signature and seal are not valid. This EC Type-approval Certificate may not be reproduced other than in full. Extracts may be taken only with the permission of the Physikalisch-Technische Bundesanstalt.



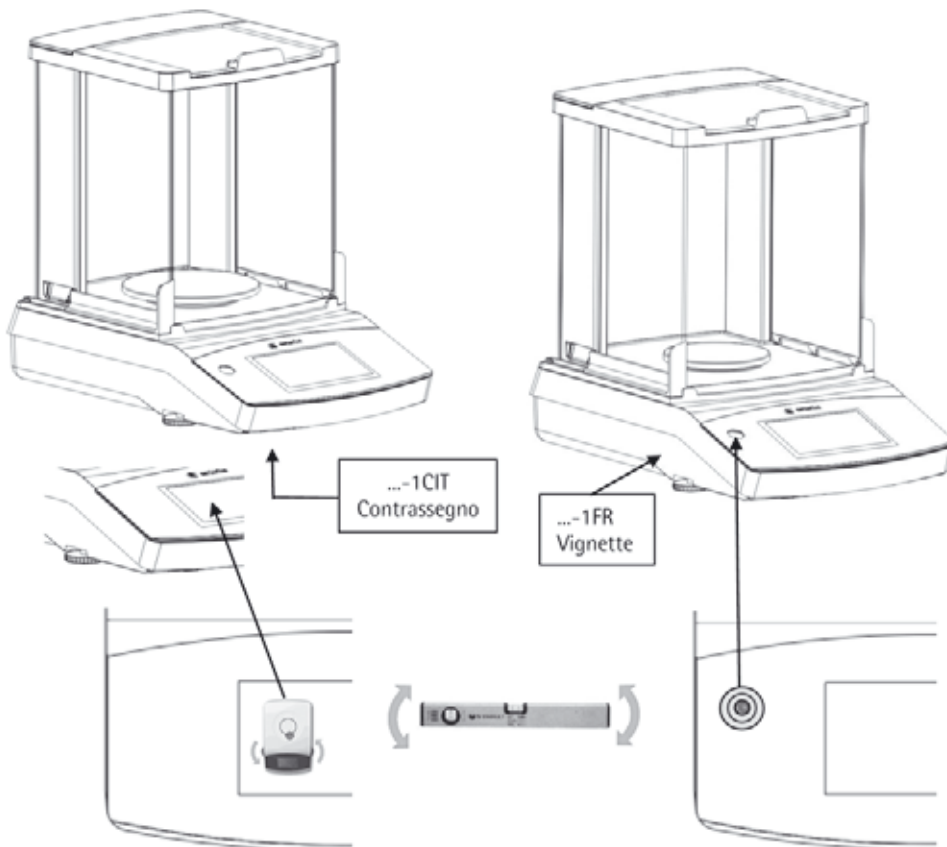
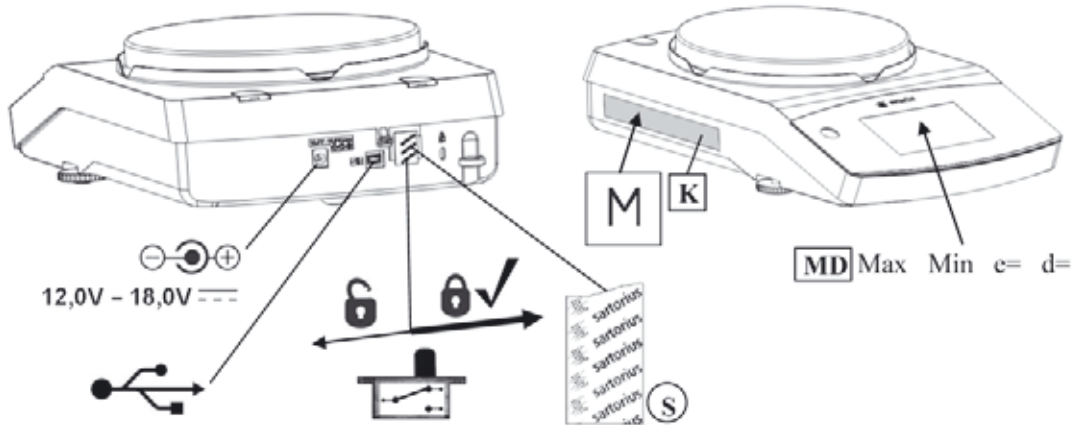

Die Hauptmerkmale, Zulassungsbedingungen und Auflagen sind in der Anlage enthalten, die Bestandteil der EG-Bauartzulassung ist. *The principal characteristics, the approval conditions and the special conditions, if any, are set out in the Annex which forms an integral part of the EC Type-approval Certificate.*

**Schilder und Marken / Plates and Markings / Plaques et marques /
Placas y Marcas / Etichette e Sigilli**



Typ Waage / Type weighing instrument / Type d'instrument de pesage / Tipo del instrumento de pesaje / Tipo di strumento per pesare:
 SOP-A, SOP-B, SOP-C, SOP-E
 EG Bauartzulassung / EC type-approval certificate / Certificat d'approbation CE de type / Certificado de aprobación CE de tipo /
 Certificato di Approvazione CE del Tipo: D12-09-014

PPSQ211013

- K** Kennzeichnungsschild mit CE-Zeichen / Descriptive plate with CE-sign / Plaque d'identification avec marque CE de conformité / Placa de características con la marca CE / Etichetta d'identificazione con marchio CE
- M** Zeichen für die EG-Eichung (grüne Marke mit Messtechnik-M) / Mark for EC verification (green metrology sticker) / Marque de vérification CE (M vert) / Marca verde con letra M de metrologia / Marchio di verifica CE (bollino verde con lettera stampata M)
- S** Sicherungsstempel (selbstklebende Marke oder Plombe) / Protective mark (self-adhesive mark or seal) / Marque de protection (marque ou sceau autocollant) / Sello de seguridad (marca autoadhesiva o precinto) / Sigillo di protezione (bollino autoadesivo o piombo)
- MD** Metrologische Daten Max, Min, e und wenn vorhanden d / Metrological data Max, Min, e and if existent d / Données métrologiques : Max, Min, e et, si disponible, d / Datos metrológicos: Máx, Min, e y d, si está disponible / Dati metrologici: Max, Min, e, e d se disponibile
-  Programmverriegelungsschalter / Menu access switch / Commutateur d'accès au menu / Interruptor de bloqueo de programa / Commutatore di accesso al menu
-  gesperrt / locked / verrouillé / bloqueado / bloccato
-  USB Schnittstelle / USB interface / Interface USB / Interfaz USB / Interfaccia USB
-  Spannungsversorgung / Power supply / Alimentation / Fuente de alimentación / Alimentazione

Beispiel für Kennzeichnungsschild der bereits geeichten Waage **K**
 Example of descriptive plate on a weighing instrument already verified
 Exemple de plaque d'identification d'une balance vérifiée
 Ejemplo de rótulo de características del instrumento de pesaje ya verificado
 Esempio di etichetta d'identificazione dello strumento per pesare già omologato



Typ Waage / Type weighing instrument / Type d'instrument de pesage / Tipo del instrumento de pesaje / Tipo di strumento per pesare:
 SQP-A, SQP-B, SQP-C, SQP-E
 EG Bauartzulassung / EC type-approval certificate / Certificat d'approbation CE de type / Certificado de aprobación CE de tipo /
 Certificato di Approvazione CE del Tipo: D12-09-014

PPSQ211013

Sartorius Lab Instruments GmbH & Co. KG
Weender Landstrasse 94–108
37075 Goettingen, Germany

Phone: +49.551.308.0
Fax: +49.551.308.3289
www.sartorius.com

The information and figures contained in these instructions correspond to the version date specified below.

Sartorius reserves the right to make changes to the technology, features, specifications and design of the equipment without notice.

Copyright notice:

This instruction manual, including all of its components, is protected by copyright. Any use beyond the limits of the copyright law is not permitted without our approval. This applies in particular to reprinting, translation and editing irrespective of the type of media used.

© Sartorius Germany

Last updated:
08 | 2015