

Corning® Stripettor™ Ultra Pipet Controller

CORNING

Instruction Manual

Catalog Number:
4099

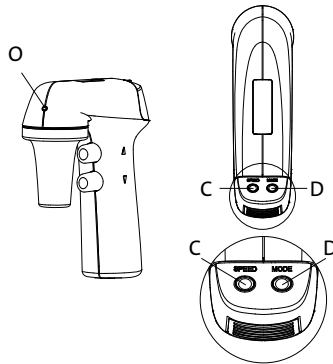
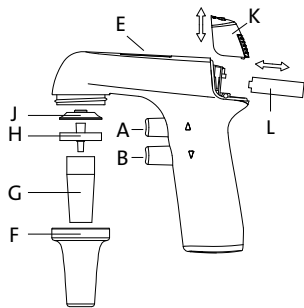
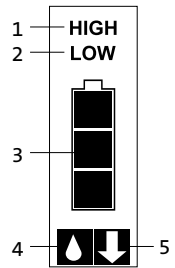

This manual is available in additional languages at www.corning.com/lifesciences.

1**2****3**

1

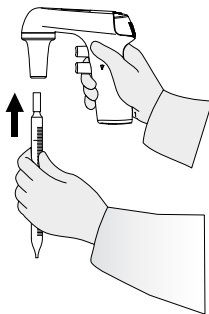

2

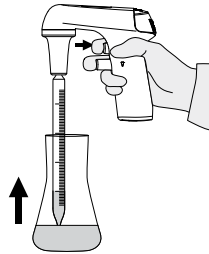

3

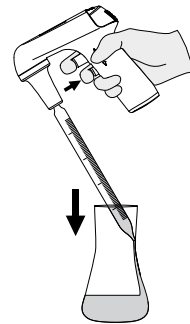

A – Aspiration button – PP
 B – Dispense button – PP
 C – Suction speed switch – PP
 D – Dispense mode switch – PP
 E – Display
 F – Nose piece – PP
 G – Pipet holder – SI
 H – Membrane filter – PP/PTFE
 J – Connector gasket – SI
 K – Battery cover – PP
 L – Battery – NiMH, AAA, 1.2V
 M – Wall mount – PP

N – Charger 9V: EU, US, UK, AU
 INPUT: 100-240V, 50/60Hz, 0.3A
 OUTPUT: AC DC 9V, 230mA
 O – Direct outlet of liquid vapors
 P – Charging stand

PP: Polypropylene
 PTFE: Polytetrafluoroethylene
 SI: Silicone

Casing – PP

4**5****6****7****8****9**

Table of Contents

1. Introduction	5
2. Work Safety Instructions	5
3. Limitations of Use	6
4. Switching On	6
5. Aspirating and Dispensing Liquids	6
6. Troubleshooting	8
7. Replacing the Filter	8
8. Charging the Batteries	9
9. Maintenance	9
10. Components	10
11. Ordering Information	10
12. Spare Parts for Corning Cat. No. 4099	11
13. Limited Warranty	11
14. Equipment Disposal	12

1. Introduction

The pipet controller is a device intended for pipetting liquids with the use of measuring pipets. It can work with all types of glass or plastic pipets in the volume range from 0.5 mL to 100 mL. Two dispense modes permit selection of dispensing intensity depending on the user's needs. The selected setting of the pipet controller mode is shown on the display (Figure 1E).

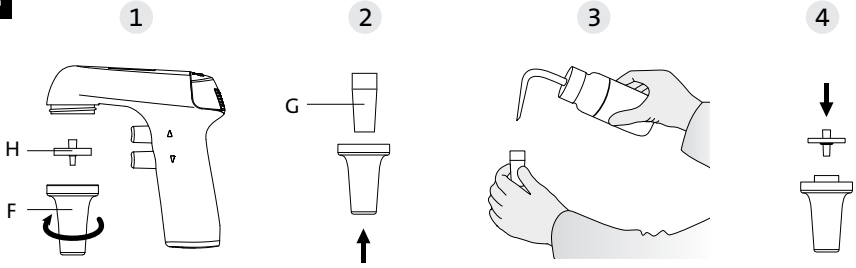
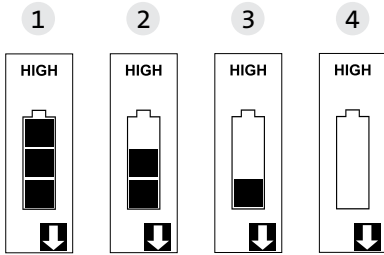
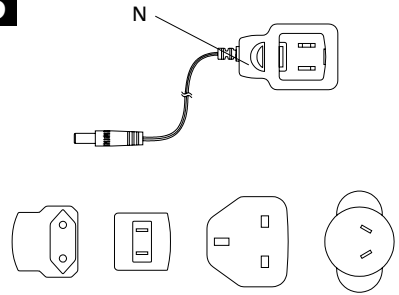
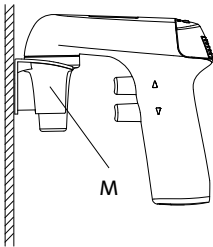
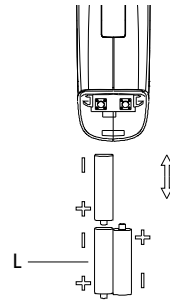
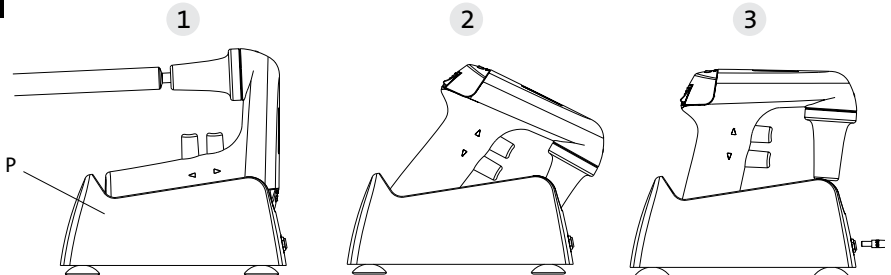
Figure 1 shows the external parts of the pipet controller with a description of the materials used. Display indicators are shown in Figure 2.

2. Work Safety Instructions

WARNING! Risk of injury

CAUTION: Risk of damage to the device or errors in pipetting of liquids.

Before starting the work with the pipet controller every user should read these operating instructions carefully.

CAUTION:

- Using the device inconsistently with the operating instructions may result in damaging the device.
- The device should be serviced only at an authorized service center, otherwise the manufacturer will be relieved from any liability under the warranty.
- Only original spare parts and accessories, recommended by the manufacturer, shall be used.
- Only the original charger, supplied by the manufacturer, shall be used for charging the batteries.
- In case of incorrect functioning of the pipet controller, work shall be stopped. The device shall be cleaned according to section 9 and sent for repair to an authorized service center.
- In the case of mechanical damage to the casing, the device shall be immediately sent for repair to an authorized service center.
- The use of excessive force during work shall be avoided.

WARNING!

- During the work with the pipet controller general safety regulations regarding risks related with laboratory work should be observed. Protective clothing, goggles, and gloves should be worn.
- The pipet controller shall be used only for measuring liquids in conditions specified by the manufacturer, which are limited due to the chemical and mechanical resistance of the device, as well as the user safety.
- The information and instructions provided by the manufacturers of the reagents must be observed.

NOTE: The pipet controller is equipped with liquid vapors exhaustion system which protects against corrosion to ensure long instrument life.

3. Limitations of Use

- The pipet controller shall not be used for measuring substances with vapours of which damage the following plastics: PP, SI, EPDM, POM.
- The pipet controller shall not be used in an environment where explosion risk is present.
- Flammable liquids shall not be measured – in particular substances with flash-point below 0°C (ether, acetone).
- The pipet controller shall not be used for drawing acids with a concentration above 1 mol/L.
- The pipet controller shall not be used for drawing solutions with a temperature above 50°C.
- The pipet controller may work in temperature range from +10°C to +35°C.

The pipet controller is suitable for general laboratory use only. It must be used only by personnel who know the health risks associated with the substances that are normally used with this instrument.

4. Switching On

The pipet controller is switched on by pressing any of the buttons (Figure 1A, B, C, D). The display will show the selected aspiration mode, dispense mode and the batteries level indicator. Examples of the display indications are shown in (Figure 5). The batteries are discharged and require charging if the indicator does not display “bars” (Figure 5.4). When the batteries are fully charged, the indicator displays three “bars” (Figure 5.1).

- The pipet controller switches off automatically if not used for 5 minutes.
- The pipet controller may be charged only with the original charger.
- The mains voltage shall conform with the specification on the charger.
- Charging shall be done in accordance with section 8 of the instruction manual.

5. Aspirating and Dispensing Liquids

Attaching a pipet

CAUTION: Before attaching a pipet, check whether the pipet is not damaged, has no dents or sharp edges in the gripping part. Check whether the gripping part is dry.

The pipet shall be gripped as close to the upper end as possible and carefully inserted into the pipet holder until resistance is noticed (Figure 3.1).

WARNING!

Do not apply excessive force so as not to damage thin pipets and avoid risk of injury.

A pipet that has been correctly attached and sealed in the holder should not tilt to the sides.

After attaching a pipet, hold the pipet controller in a vertical position. It is not recommended to leave the device with a pipet attached for a longer period, for example overnight or over a weekend.

CAUTION: Do not put aside the pipet controller if there is liquid in the pipet.

Filling the pipet

Before aspirating is started, set the speed by pressing the SPEED switch (Figure 1C) until the display shows the correct speed (Figure 1E).

- HIGH speed - fast aspirating (Figure 2.1),
- LOW speed - slow aspirating (Figure 2.2).

It is recommended to set the LOW speed when working with pipets of volumes up to 5 mL, and the HIGH speed for pipets of volumes greater than 5 mL. Holding the pipet controller in a vertical position, immerse the pipet end in the liquid to be drawn up (Figure 3.2), and press the aspiration button gently. The speed depends on how deep the aspirating button has been pressed. The deeper the button is pressed the faster the liquid is aspirated into the pipet.

It is recommended to draw a slightly greater liquid volume than required (due to meniscus above the required volume mark), adjusting the aspiration speed, so as not to overfill the pipet.



Setting the volume

After the pipet is filled, dry the outside surface with absorbent paper that does not leave impurities. Then set the required liquid volume precisely. Pressing the dispense button gently (Figure 3.3), dispense the excessive liquid from the pipet until the meniscus of the liquid aligns exactly with the required volume mark on the pipet.

Emptying the pipet

Holding the vessel in an inclined position, place the pipet end in contact with the vessel wall and press the dispense button gently (Figure 3.3). The dispensing intensity may be adjusted depending on how deep the dispense button has been pressed. The deeper the button is pressed the faster the outflow of liquid from the pipet.

The pipet controller has two dispense modes. The dispense mode is selected by successive pressing the MODE switch (Figure 1D) until the display shows the correct mode (Figure 1E).

- Gravity mode marked with the  icon on the display (Figure 2.4) – dispensing is effected in gravity mode, which means that the liquid flows out of the pipet by its own weight.
- Blow out mode marked with the  icon on the display (Figure 2.5) – dispensing is effected in gravity mode, however, when the dispense button is pressed to the middle position, the pump is started and fast emptying of the pipet with a blow out is effected.

CAUTION: During gravimetric dispensing the pipet is not completely emptied due to the characteristics of pipets used with the pipet controller.

6. Troubleshooting

If during your work the pipet controller is not functioning correctly, check the cause and correct the fault.

Problem	Possible Cause	Action
The pipet falls out (the holding force of the pipet is too small), or tilts to the side too much.	The pipet holder (Figure 1G) is dirty or wet.	Take out the pipet holder, and clean, wash, and dry it.
	The pipet holder is damaged.	Replace the pipet holder with a new one.
The pump is working, but the pipet controller aid does not draw liquid or draws liquid very slowly.	The filter (Figure 1H) is dirty.	Take out the pipet holder, take out the filter; if it is dirty, replace it with a new one.
	The pipet holder and/or the connector gasket (Figure 1J) is damaged.	Replace the mechanically damaged elements with new ones.
	The pipet is damaged.	Check the pipet for damage (cracks, dents); if present, replace the pipet with a new one.
Liquid leaks from the pipet (the aspiration and the dispense buttons are not pressed).	The pipet is inserted incorrectly.	Check whether the pipet has been correctly inserted in the pipet holder.
	The pipet holder, the filter, or the connector gasket is installed incorrectly.	Check whether all parts are present and correctly installed.
	The pipet holder and/or the connector gasket is damaged (Figures 1G, 1J).	Replace the mechanically damaged elements with new ones.

If the above actions do not help, the device shall be sent to the nearest authorized service center. Before being serviced, the pipet controller should be cleaned and decontaminated. Written details including the precise specification of solutions used and the type of laboratory in which the device was used, should be sent with the product.

7. Replacing the Filter

CAUTION: The work safety instructions given in section 2 shall be observed when disassembling the pipet controller.

The filter replacement is necessary, if drawing efficiency deterioration is observed. The direct reason may be a dirty filter after a long period of use. In order to replace the filter:

- Remove the pipet.
- Unscrew the nose piece (Figure 4.1).
- Remove the membrane filter (Figure 4.1) and the pipet holder (Figure 4.2).
- Rinse the holder using a wash bottle (Figure 4.3).

- Blow liquid out of the holder and set it aside until it is completely dry.
- Install new membrane filter (Figure 4.4) and assemble the device in reverse order.

8. Charging the Batteries

CAUTION: The pipet controller may be charged only with the original charger. The mains voltage shall conform with the specification on the charger (Input: 100-240V, 50/60Hz, 0.2A; output: 9V).

Using chargers other than the original one may damage the battery.

The pipet controller is delivered with 3 NiMH type AAA batteries.

The batteries can be replaced easily if necessary after the battery cover is taken off (Figure 1K). The manner in which the batteries are arranged is shown in Figure 8.

Charging

1. Charging temperature: 10°C to 35°C.
 2. Charging the battery is carried out through a charger (power supply) by direct connection to the main power. Batteries charging is indicated by successive lighting of “bars”.
 3. Full charging time: 7 to 8 hours.
 4. The batteries are charged when all 3 “bars” are displayed simultaneously (Figure 5.1). When the batteries are charged, the charging circuit disconnects automatically. The service life of the batteries: approx. 1,000 charging cycles, if used correctly. It is not possible to overcharge the batteries if all instructions of the manufacturer are followed. Charging on charging stand (Figure 9.3)
1. Put the pipet controller on the stand.
 2. Plug the charger into the stand outlet.
 3. Connect the charger to the adapter and to the main power.

WARNING!

In order to prolong the life span of the rechargeable batteries, the following rules should be followed:

1. Before the pipet controller is activated for the first time, the batteries should be charged.
2. If the pipet controller starts to indicate low battery level during work, connect it to the power supply to continue working.
3. Do not leave the pipet controller discharged for a long period of time.
4. In case of a planned longer break in using the device, it is recommended to remove the batteries from the battery compartment or charge them every few months.

9. Maintenance

Cleaning

The pipet controller does not require any maintenance. Its external parts may be cleaned with a swab moistened with isopropyl alcohol.

The nose piece and the pipet holder may be autoclaved at 121°C for 20 minutes.

After autoclaving, dry the pipet holder. The filter included in the set may be sterilized by autoclaving at 121°C for not more than 15 minutes.

Ultra violet (UV) sterilization

The outer body of the pipet controller is UV resistant, which was confirmed by many tests. The recommended distance from the radiation source to exposed element should be not less than 50 cm.

Prolonged and very intense UV exposure can cause de-coloration of pipet controller parts, without affecting its performance.

Storage

The pipet controller should be stored in a dry place. The allowable storage temperature: -20°C to +50°C.

During breaks in the work the pipet controller can be stored on the wall hanger or charging Stand. The Corning® Stripettor™ Ultra charging stand is a device intended to conveniently charge and store a pipet controller when not in use. Three positions (Figure 9) to store the pipet controller, depending on user needs, are also visible as icons printed on the stand.

- Break position (Figure 9.1)
Convenient while working, helps to avoid contamination.
- Rest position (Figure 9.2)
Ideal way to store a pipet controller after use.
- Charging position (Figure 9.3)
Used while pipet controller is in charging process.

CAUTION: Do not store the pipet controller with a filled pipet.

10. Components

The pipet controller set is supplied with the following components:

- Universal charger with set of adapters
- PTFE filter 0.2 µm (3)
- Batteries (3 AAA)
- Instruction manual
- Wall hanger
- Charging stand
- Set of colored nose pieces (3: yellow, green, red)

11. Ordering Information

The Corning Stripettor Ultra Pipet Controller (Cat. No. 4099) comes with a universal charger and a set of adapters in different versions: EU, US, UK, and AUS. Choose your country's adapter and connect to the housing.

To mount the adapter, it should be inserted into the slots of the housing in the direction of the arrow (1), until you hear a click (Figure 6).

To remove or change the adapter, simply press the "PUSH" button in the direction of the arrow (2), hold the button down, remove the adapter in the direction of the arrow (3).

12. Spare Parts for Corning Cat. No. 4099

Item in Figure 1	Description	Corning Cat. No.	Qty/Pk
F	Set of 4 colored nose pieces (orange, yellow, green, red)	4997	4
G	Silicone pipet holder	4993	1
H	PTFE filter 0.2 μm	4991	5
	PTFE filter 0.45 μm	4992	5
L	Battery set, 3xAAA, NiHM	4994	3
M	Charging stand	4998	1
N	Universal power supply, 9V with set of adapters: EU, US, UK, AUS	4996	1

13. Limited Warranty

Corning Incorporated (Corning) warrants that this product will be free from defects in material and workmanship for a period of two (2) years from date of purchase. CORNING DISCLAIMS ALL OTHER WARRANTIES WHETHER EXPRESSED OR IMPLIED, INCLUDING ANY IMPLIED WARRANTIES OF MERCHANTABILITY OR OF FITNESS FOR A PARTICULAR PURPOSE. Corning's sole obligation shall be to repair or replace, at its option, any product or part thereof that proves defective in material or workmanship within the warranty period, provided the purchaser notifies Corning of any such defect. Corning is not liable for any incidental or consequential damages, commercial loss or any other damages from the use of this product.

This warranty is valid only if the product is used for its intended purpose and within the guidelines specified in the supplied instruction manual. This warranty does not cover damage caused by accident, neglect, misuse, improper service, natural forces or other causes not arising from defects in original material or workmanship. This warranty does not cover batteries or damage to paint or finish. Claims for transit damage should be filed with the transportation carrier.

In the event this product fails within the specified period of time because of a defect in material or workmanship, contact Corning's Customer Service at the following numbers: USA: 1.800.492.1110; Canada: 1.978.442.2200. For other regions of the world, visit www.corning.com/lifesciences or see the included instruction manual for a list of Worldwide Support Offices.

Corning's Customer Service team will help arrange local service where available or coordinate a return authorization number and shipping instructions. Products received without proper authorization will be returned. All items returned for service should be sent postage prepaid in the original packaging or other suitable carton, padded to avoid damage. Corning will not be responsible for damage incurred by improper packaging. Corning may elect for onsite service for larger equipment. Some states do not allow limitation on the length of implied warranties or the exclusion or limitation of incidental or consequential damages. This warranty gives you specific legal rights. You may have other rights which vary from state to state.

No individual may accept for, or on behalf of Corning, any other obligation of liability, or extend the period of this warranty.

For your reference, make a note of the serial and model number, date of purchase, and supplier here.

Serial No. _____ Date Purchased _____

Model No. _____

Supplier _____

14. Equipment Disposal

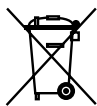

According to Directive 2012/19/EU of the European Parliament and of the Council of 4 July 2012 on waste electrical and electronic equipment (WEEE), the Corning® Stripettor™ Ultra Pipet Controller is marked with the crossed-out wheeled bin and must not be disposed of with domestic waste.

Consequently, the buyer shall follow the instructions for reuse and recycling of waste electronic and electrical equipment (WEEE) provided with the products and available at www.corning.com/weee.

CORNING

Corning Incorporated

Life Sciences

836 North St.
Building 300, Suite 3401
Tewksbury, MA 01876
t 800.492.1110
t 978.442.2200
f 978.442.2476

www.corning.com/lifesciences

Worldwide Support Offices

ASIA/PACIFIC

Australia/New Zealand

t 61 427 286 832

Chinese Mainland

t 86 21 3338 4338

f 86 21 3338 4300

India

t 91 124 460 4000

f 91 124 460 4099

Japan

t 81 3 3586 1996

f 81 3 3586 1291

Korea

t 82 2 796 9500

f 82 2 796 9300

Singapore

t 65 6572 9740

f 65 6735 2913

Taiwan

t 886 2 2716 0338

f 886 2 2516 7500

EUROPE

France

t 0800 916 882

f 0800 918 636

Germany

t 0800 101 1153

f 0800 101 2427

The Netherlands

t 020 655 79 28

f 020 659 76 73

United Kingdom

t 0800 376 8660

f 0800 279 1117

All Other European Countries

t 31 (0) 20 659 60 51

f 31 (0) 20 659 76 73

LATIN AMERICA

grupoLA@corning.com

Brazil

t (55-11) 3089 7400

Mexico

t (52-81) 8158 8400

Warranty/Disclaimer: Unless otherwise specified, all products are for research use only. Not intended for use in diagnostic or therapeutic procedures. Corning Life Sciences makes no claims regarding the performance of these products for clinical or diagnostic applications.

For additional product or technical information, visit www.corning.com/lifesciences or call 800.492.1110. Outside the United States, call +1.978.442.2200 or contact your local Corning sales office.

© 2015, 2020 Corning Incorporated. All rights reserved. 3/20 CLS-EQ-113 REV4/H-STR-IM REV2



Corning Incorporated, Daniszewska 4, 03-230 Warsaw
www.corning.com/lifesciences

Made in Poland

For a listing of trademarks, visit www.corning.com/clstrademarks. All other trademarks are the property of their respective owners.